

MSQA6V1W5T2

Quad Array for ESD Protection

This quad monolithic silicon voltage suppressor is designed for applications requiring transient overvoltage protection capability. It is intended for use in voltage and ESD sensitive equipment such as computers, printers, business machines, communication systems, medical equipment, and other applications. Its quad junction common anode design protects four separate lines using only one package. These devices are ideal for situations where board space is at a premium.

Features

- SC-88A Package Allows Four Separate Unidirectional Configurations
- Low Leakage < 1 μA @ 3 V
- Breakdown Voltage: 6.1 V – 7.2 V @ 1 mA
- Low Capacitance (90 pF typical)
- ESD Protection Meeting IEC1000-4-2
- Pb-Free Package is Available*

Mechanical Characteristics:

- Void Free, Transfer-Molded, Thermosetting Plastic Case
- Corrosion Resistant Finish, Easily Solderable
- Package Designed for Optimal Automated Board Assembly
- Small Package Size for High Density Applications

MAXIMUM RATINGS

Rating	Symbol	Value	Unit
Peak Power Dissipation @ 20 μs @ $T_A \leq 25^\circ\text{C}$ (Note 1)	P_{pk}	150	W
Steady State Power – 1 Diode (Note 2)	P_D	385	mW
Thermal Resistance, Junction-to-Ambient Above 25°C , Derate	$R_{\theta JA}$	325 3.1	$^\circ\text{C}/\text{W}$ $\text{mW}/^\circ\text{C}$
Maximum Junction Temperature	T_{Jmax}	150	$^\circ\text{C}$
Operating Junction and Storage Temperature Range	T_J T_{stg}	-55 to +150	$^\circ\text{C}$
ESD Discharge MIL STD 883C – Method 3015-6 IEC1000-4-2, Air Discharge IEC1000-4-2, Contact Discharge	V_{PP}	16 16 9	kV
Lead Solder Temperature (10 s duration)	T_L	260	$^\circ\text{C}$

Maximum ratings are those values beyond which device damage can occur. Maximum ratings applied to the device are individual stress limit values (not normal operating conditions) and are not valid simultaneously. If these limits are exceeded, device functional operation is not implied, damage may occur and reliability may be affected.

1. Non-repetitive current per Figure 1. Derate per Figure 2.
2. Only 1 diode under power. For all 4 diodes under power, P_D will be 25%. Mounted on FR-4 board with min pad.

*For additional information on our Pb-Free strategy and soldering details, please download the ON Semiconductor Soldering and Mounting Techniques Reference Manual, SOLDERRM/D.



ON Semiconductor®

<http://onsemi.com>

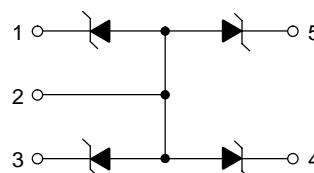

SC-88A/SOT-323
CASE 419A

MARKING DIAGRAM

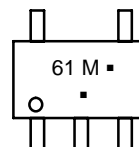

61 = Device Code
M = Date Code
▪ = Pb-Free Package
(Note: Microdot may be in either location)

ORDERING INFORMATION

Device	Package	Shipping†
MSQA6V1W5T2	SC-88A	3000/Tape & Reel
MSQA6V1W5T2G	SC-88A (Pb-Free)	3000/Tape & Reel

†For information on tape and reel specifications, including part orientation and tape sizes, please refer to our Tape and Reel Packaging Specification Brochure, BRD8011/D.

*T2 Suffix Devices are Packaged with Pin 1 Opposing Sprocket Hole.

MSQA6V1W5T2

ELECTRICAL CHARACTERISTICS

Device	Breakdown Voltage V_{BR} @ 1 mA (Volts)			Leakage Current I_{RM} @ $V_{RWM} = 3$ V (μ A)	Capacitance @ 0 V Bias (pF)	Max V_F @ $I_F = 200$ mA (V)
	Min	Nom	Max			
MSQA6V1W5	6.1	6.6	7.2	1.0	90	1.25

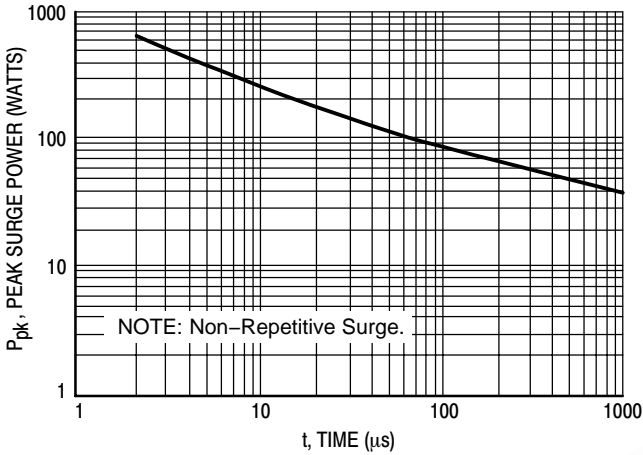

Figure 1. Pulse Width

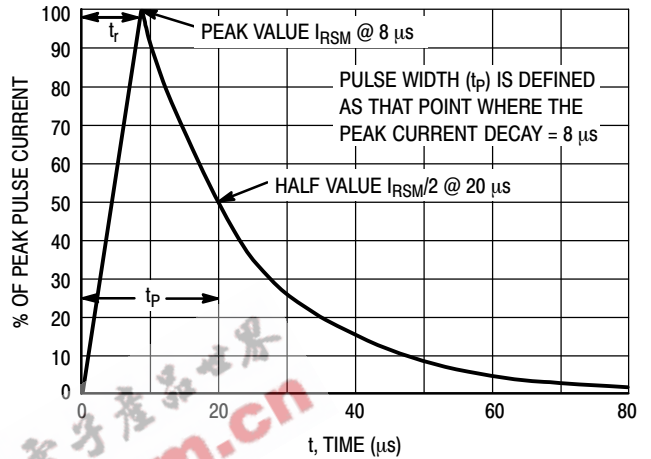

Figure 2. 8 x 20 μ s Pulse Waveform

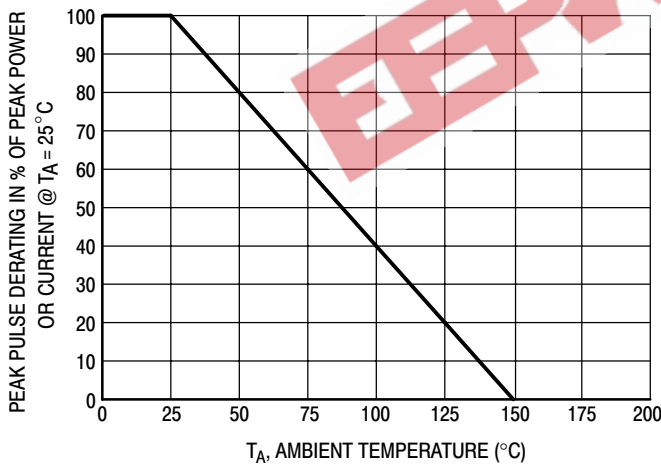

Figure 3. Pulse Derating Curve

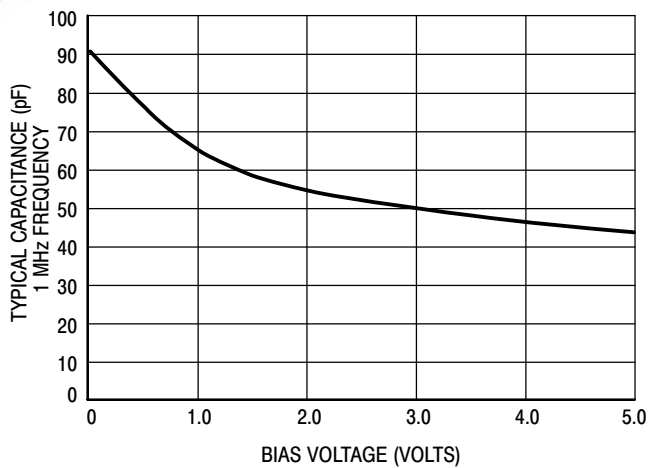

Figure 4. Capacitance

MSQA6V1W5T2

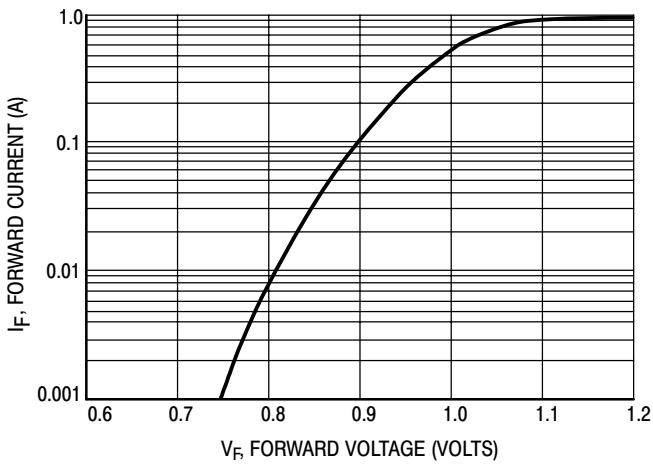

Figure 5. Forward Voltage

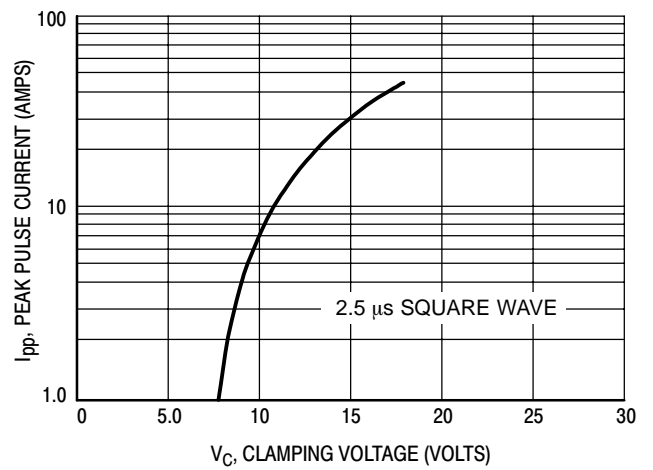

Figure 6. Clamping Voltage versus Peak Pulse Current (Reverse Direction)

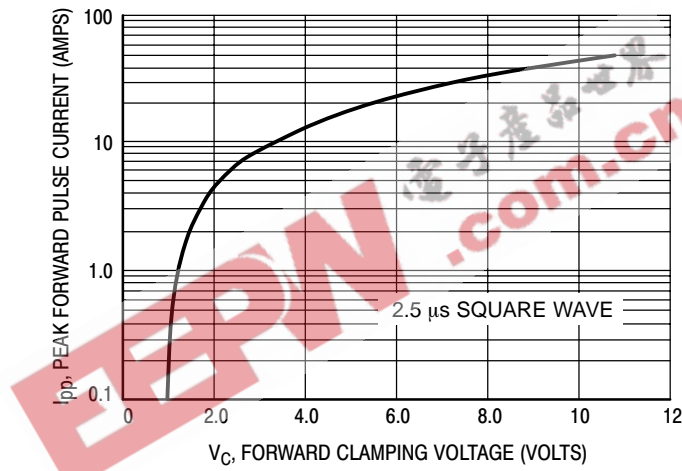
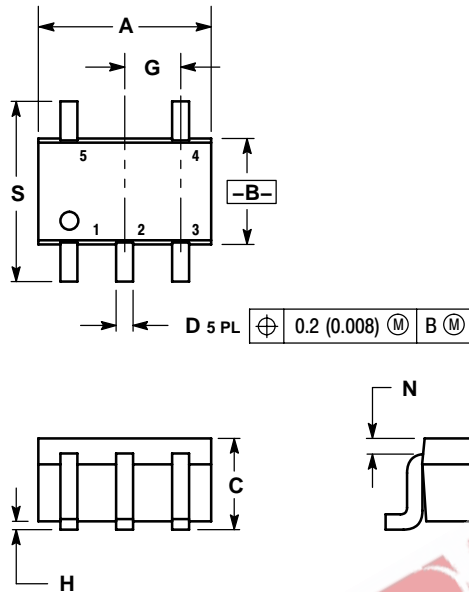

Figure 7. Clamping Voltage versus Peak Pulse Current (Forward Direction)

MSQA6V1W5T2

PACKAGE DIMENSIONS

SC-88A / SOT-353 / SC-70
CASE 419A-02
ISSUE J



NOTES:

1. DIMENSIONING AND TOLERANCING PER ANSI Y14.5M, 1982.
2. CONTROLLING DIMENSION: INCH.
3. 419A-01 OBSOLETE. NEW STANDARD 419A-02.
4. DIMENSIONS A AND B DO NOT INCLUDE MOLD FLASH, PROTRUSIONS, OR GATE BURRS.

DIM	INCHES		MILLIMETERS	
	MIN	MAX	MIN	MAX
A	0.071	0.087	1.80	2.20
B	0.045	0.053	1.15	1.35
C	0.031	0.043	0.80	1.10
D	0.004	0.012	0.10	0.30
G	0.026 BSC		0.65 BSC	
H	---	0.004	---	0.10
J	0.004	0.010	0.10	0.25
K	0.004	0.012	0.10	0.30
N	0.008	REF	0.20	REF
S	0.079	0.087	2.00	2.20

ON Semiconductor and are registered trademarks of Semiconductor Components Industries, LLC (SCILLC). SCILLC reserves the right to make changes without further notice to any products herein. SCILLC makes no warranty, representation or guarantee regarding the suitability of its products for any particular purpose, nor does SCILLC assume any liability arising out of the application or use of any product or circuit, and specifically disclaims any and all liability, including without limitation special, consequential or incidental damages. "Typical" parameters which may be provided in SCILLC data sheets and/or specifications can and do vary in different applications and actual performance may vary over time. All operating parameters, including "Typicals" must be validated for each customer application by customer's technical experts. SCILLC does not convey any license under its patent rights nor the rights of others. SCILLC products are not designed, intended, or authorized for use as components in systems intended for surgical implant into the body, or other applications intended to support or sustain life, or for any other application in which the failure of the SCILLC product could create a situation where personal injury or death may occur. Should Buyer purchase or use SCILLC products for any such unintended or unauthorized application, Buyer shall indemnify and hold SCILLC and its officers, employees, subsidiaries, affiliates, and distributors harmless against all claims, costs, damages, and expenses, and reasonable attorney fees arising out of, directly or indirectly, any claim of personal injury or death associated with such unintended or unauthorized use, even if such claim alleges that SCILLC was negligent regarding the design or manufacture of the part. SCILLC is an Equal Opportunity/Affirmative Action Employer. This literature is subject to all applicable copyright laws and is not for resale in any manner.

PUBLICATION ORDERING INFORMATION

LITERATURE FULFILLMENT:

Literature Distribution Center for ON Semiconductor
P.O. Box 61312, Phoenix, Arizona 85082-1312 USA
Phone: 480-829-7710 or 800-344-3860 Toll Free USA/Canada
Fax: 480-829-7709 or 800-344-3867 Toll Free USA/Canada
Email: orderlit@onsemi.com

N. American Technical Support: 800-282-9855 Toll Free
USA/Canada

Japan: ON Semiconductor, Japan Customer Focus Center
2-9-1 Kamimeguro, Meguro-ku, Tokyo, Japan 153-0051
Phone: 81-3-5773-3850

ON Semiconductor Website: <http://onsemi.com>

Order Literature: <http://www.onsemi.com/litorder>

For additional information, please contact your local Sales Representative.

MSQA6V1W5T2/D