



**N5027**

**NPN SILICON TRANSISTOR**

HIGH VOLTAGE AND HIGH RELIABILITY NPN TRANSISTOR

■ FEATURES

- \* High Voltage ( $V_{CEO} = 800V$ )
- \* High Speed Switching
- \* Wide SOA

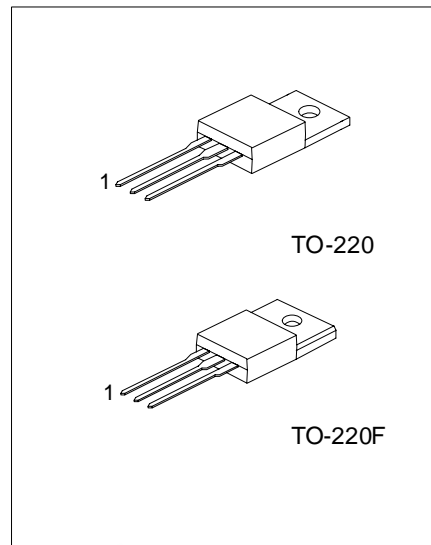

\*Pb-free plating product number: N5027L

■ ORDERING INFORMATION

Order Number		Package	Pin Assignment			Packing
Normal	Lead Free Plating		1	2	3	
N5027-x-TA3-F-T	N5027L-x-TA3-F-T	TO-220	B	C	E	Tube
N5027-x-TF3-F-T	N5027L-x-TF3-F-T	TO-220F	B	C	E	Tube

<p>N5027L-x-TA3-F-T</p>	<ul style="list-style-type: none"> <li>(1) T: Tube</li> <li>(2) refer to Pin Assignment</li> <li>(3) TA3: TO-220, TF3: TO-220F</li> <li>(4) x: refer to Classification of <math>h_{FE1}</math></li> <li>(5) L: Lead Free Plating Blank: Pb/Sn</li> </ul>
-------------------------	--

■ ABSOLUTE MAXIMUM RATINGS ( $T_c = 25$  )

PARAMETER	SYMBOL	RATINGS	UNIT
Collector-Base Voltage	$V_{CBO}$	850	V
Collector-Emitter Voltage	$V_{CEO}$	800	V
Collector-Emitter Voltage	$V_{EBO}$	7	V
Peak Collector Current	$I_C$	3	A
Collector Current (Pulse)	$I_{CP}$	10	A
Base Current	$I_B$	1.5	A
Peak Collector Consume Dissipation	$P_C$	50	W
Peak Junction Temperature	$T_J$	150	
Storage Temperature	$T_{STG}$	-55 ~ +150	

Note Absolute maximum ratings are those values beyond which the device could be permanently damaged.

Absolute maximum ratings are stress ratings only and functional device operation is not implied.

■ ELECTRICAL CHARACTERISTICS ( $T_c = 25$  , unless otherwise specified.)

PARAMETER	SYMBOL	TEST CONDITIONS	MIN	TYP	MAX	UNIT
Collector-Base Breakdown Voltage	$BV_{CBO}$	$I_C=1mA, I_E=0$	850			V
Collector-Emitter Breakdown Voltage	$BV_{CEO}$	$I_C=5mA, I_B=0$	800			V
Emitter-Base Breakdown Voltage	$BV_{EBO}$	$I_E=1mA, I_C=0$	7			V
Collector-Emitter sustaining Voltage	$V_{CEX(SUS)}$	$I_C=1.5A, I_{B1}=-I_{B2}=0.3A$ $L=2mH, \text{Clamped}$	800			V
Collector Cut-off Current	$I_{CBO}$	$V_{CB}=800V, I_E=0$			10	$\mu A$
Emitter Cut-off Current	$I_{EBO}$	$V_{EB}=5V, I_C=0$			10	$\mu A$
DC Current Gain	$h_{FE1}$	$V_{CE}=5V, I_C=0.2A$	10		40	
	$h_{FE2}$	$V_{CE}=5V, I_C=1A$	6			
Collector-Emitter Saturation Voltage	$V_{CE(SAT)}$	$I_C=1A, I_B=0.3A$			1.1	V
Base-Emitter Saturation Voltage	$V_{BE(SAT)}$	$I_C=1.5A, I_B=0.3A$			1.5	V
Output Capacitance	$C_{ob}$	$V_{CB}=10V, f=1MHz, I_E=0$		60		pF
Current Gain Bandwidth Product	$f_T$	$V_{CE}=10V, I_C=0.2A$		15		MHz
Turn ON Time	$t_{ON}$	$V_{CC}=400V$			0.5	$\mu s$
Storage Time	$t_{STG}$	$I_C=5I_{B1}=-2.5I_{B2}=2A$			3	$\mu s$
Fall Time	$t_F$	$R_L=200$			0.3	$\mu s$

■ CLASSIFICATION of  $h_{FE1}$

RANK	N	R	O
RANGE	10 ~ 20	15 ~ 30	20 ~ 40

## TYPICAL CHARACTERISTICS

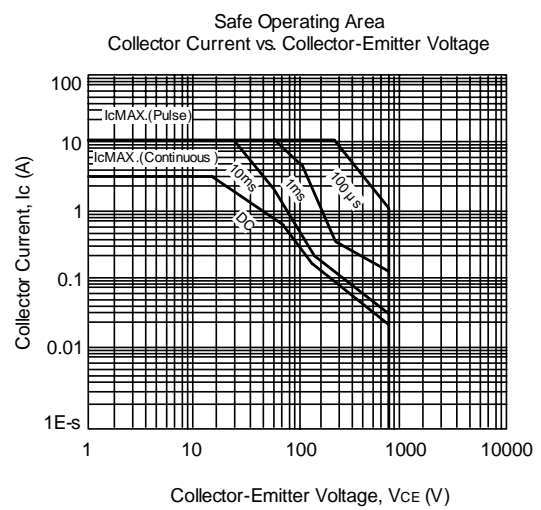
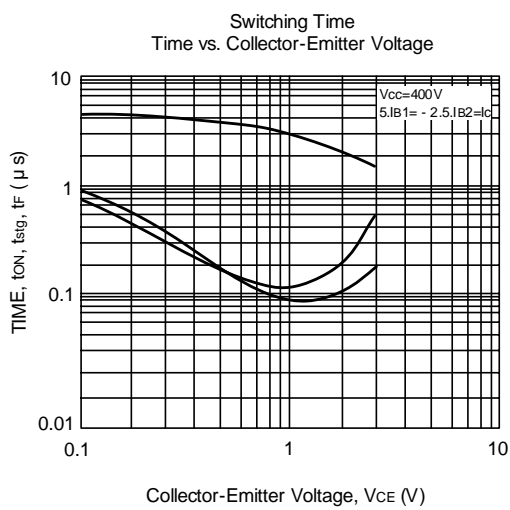
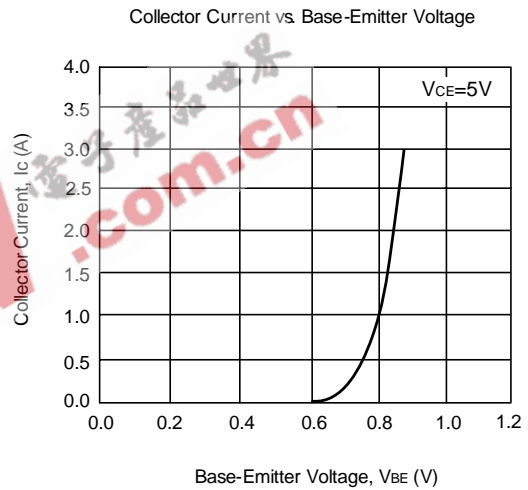
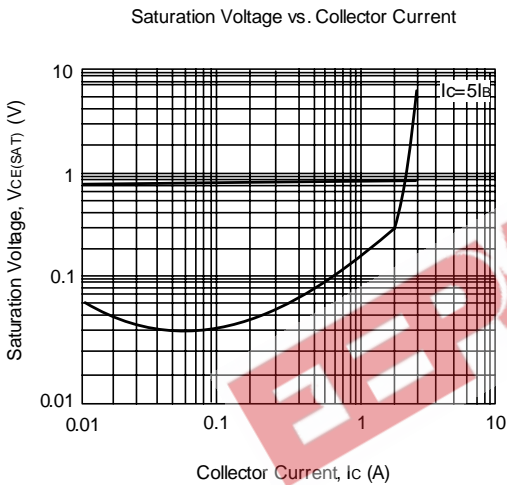
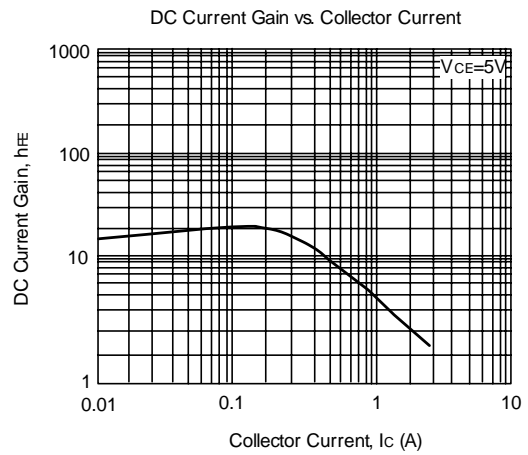
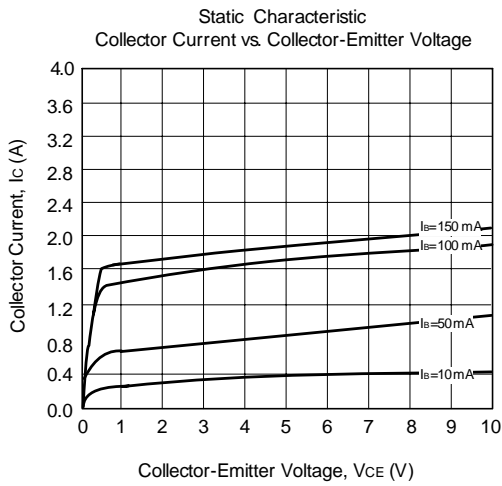

■ TYPICAL CHARACTERISTICS(Cont.)

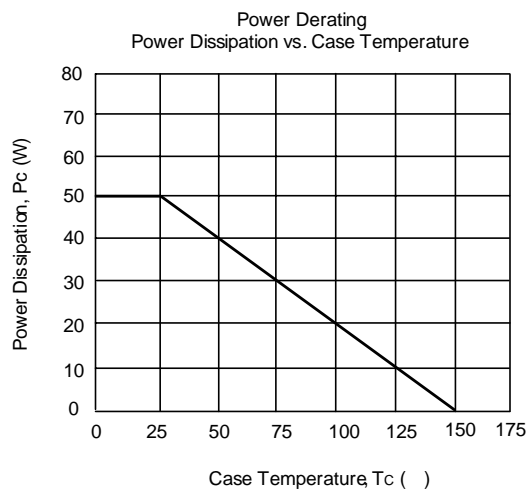
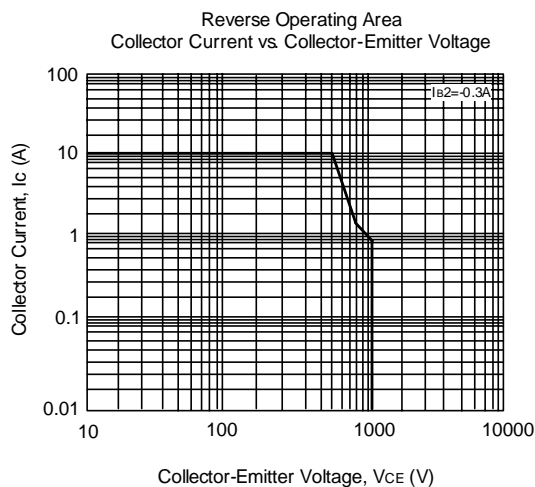

EEPW 电子产品世界 .com.cn

UTC assumes no responsibility for equipment failures that result from using products at values that exceed, even momentarily, rated values (such as maximum ratings, operating condition ranges, or other parameters) listed in products specifications of any and all UTC products described or contained herein. UTC products are not designed for use in life support appliances, devices or systems where malfunction of these products can be reasonably expected to result in personal injury. Reproduction in whole or in part is prohibited without the prior written consent of the copyright owner. The information presented in this document does not form part of any quotation or contract, is believed to be accurate and reliable and may be changed without notice.