



## SD2921

### RF POWER TRANSISTORS HF/VHF/UHF N-CHANNEL MOSFETs

- GOLD METALLIZATION
- EXCELLENT THERMAL STABILITY
- COMMON SOURCE CONFIGURATION
- POUT = 150W MIN. WITH 12.5 dB gain @175 MHz

#### DESCRIPTION

The SD2921 is a gold metallized N-Channel MOS field-effect RF power transistor. The SD2921 is intended for use in 50V dc large signal applications up to 200 MHz

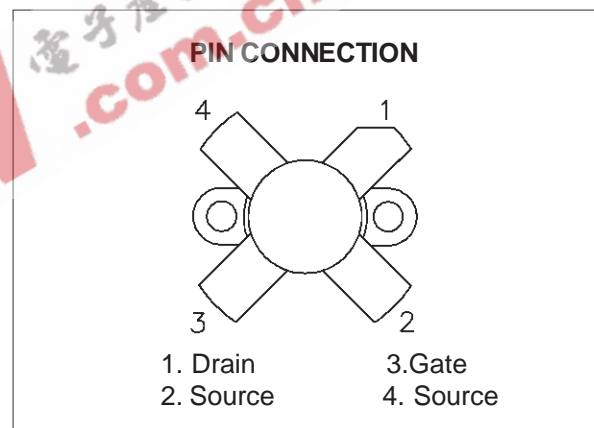
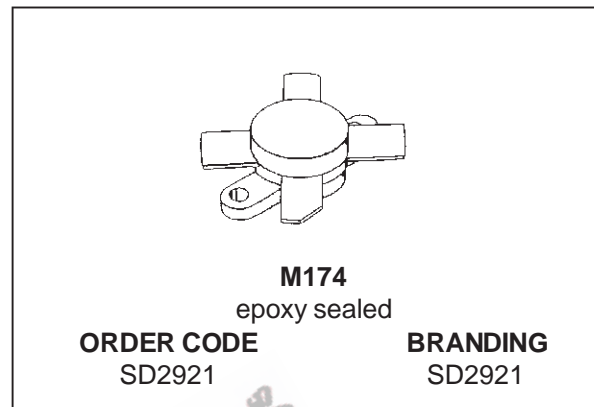

#### ABSOLUTE MAXIMUM RATINGS ( $T_{case} = 25^{\circ}C$ )

Symbol	Parameter	Value	Unit
$V_{(BR)DSS}$	Drain Source Voltage	125	V
$V_{DGR}$	Drain-Gate Voltage ( $R_{GS} = 1M\Omega$ )	125	V
$V_{GS}$	Gate-Source Voltage	$\pm 20$	V
$I_D$	Drain Current	16	A
$P_{DISS}$	Power Dissipation	292	W
$T_j$	Max. Operating Junction Temperature	200	$^{\circ}C$
$T_{STG}$	Storage Temperature	-65 to 150	$^{\circ}C$

#### THERMAL DATA

$R_{th(j-c)}$	Junction-Case Thermal Resistance	0.6	$^{\circ}C/W$
$R_{th(c-s)}$	Case-Heatsink Thermal Resistance *	0.2	$^{\circ}C/W$

\* Determined using a flat aluminum or copper heatsink with thermal compound applied (Dow Corning 340 or equivalent).

**ELECTRICAL SPECIFICATION** ( $T_{case} = 25\text{ }^{\circ}\text{C}$ )

**STATIC**

Symbol	Parameter			Min.	Typ.	Max.	Unit
$V_{(BR)DSS}$	$V_{GS} = 0V$	$I_{DS} = 100\text{ mA}$		125			V
$I_{DSS}$	$V_{GS} = 0V$	$V_{DS} = 50\text{ V}$				5	mA
$I_{GSS}$	$V_{GS} = 20V$	$V_{DS} = 0\text{ V}$				5	$\mu\text{A}$
$V_{GS(Q)}$	$V_{DS} = 10V$	$I_D = 250\text{ mA}$		1.0		5.0	V
$V_{DS(ON)}$	$V_{GS} = 10V$	$I_D = 10\text{ A}$				3.0	V
$G_{FS}$	$V_{DS} = 10V$	$I_D = 5\text{ A}$		4			mho
$C_{ISS}$	$V_{GS} = 0V$	$V_{DS} = 50\text{ V}$	$f = 1\text{ MHz}$		411		pF
$C_{OSS}$	$V_{GS} = 0V$	$V_{DS} = 50\text{ V}$	$f = 1\text{ MHz}$		198		pF
$C_{RSS}$	$V_{GS} = 0V$	$V_{DS} = 50\text{ V}$	$f = 1\text{ MHz}$		27		pF

**DYNAMIC**

Symbol	Parameter			Min.	Typ.	Max.	Unit
$P_{OUT}$	$f = 175\text{ MHz}$	$V_{DD} = 50\text{ V}$	$I_{DQ} = 250\text{ mA}$	150			W
$G_{PS}$	$f = 175\text{ MHz}$	$V_{DD} = 50\text{ V}$	$P_{out} = 150\text{ W}$	12.5	14		dB
$\eta_D$	$f = 175\text{ MHz}$	$V_{DD} = 50\text{ V}$	$P_{out} = 150\text{ W}$	55	65		%
Load Mismatch	$f = 175\text{ MHz}$	$V_{DD} = 50\text{ V}$	$P_{out} = 150\text{ W}$	10:1			VSWR
	All Phase Angles						

REF. 1021304K

**IMPEDANCE DATA**

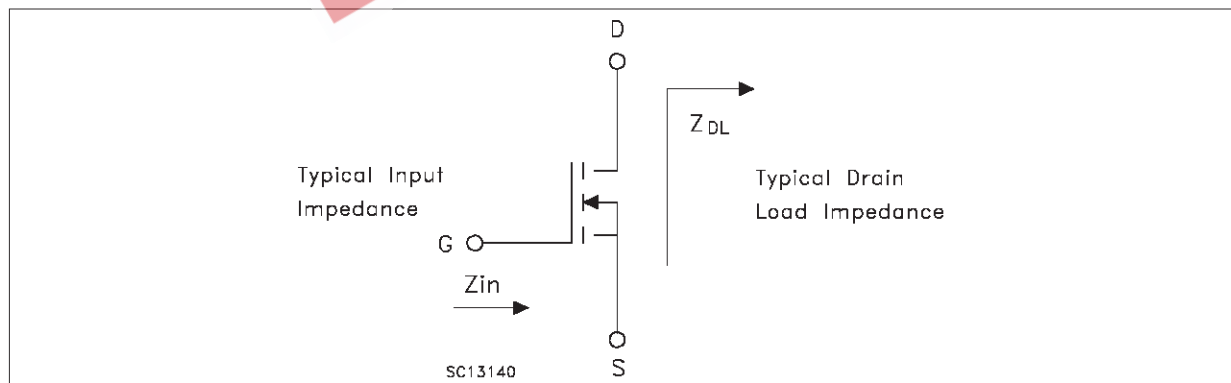

FREQ.	$Z_{IN} (\Omega)$	$Z_{DL} (\Omega)$
30 MHz	$1.7 - j 5.7$	$6.8 + j 0.9$
175 MHz	$1.2 - j 2.0$	$2.0 + j 2.4$

TYPICAL PERFORMANCE

Output Power vs Input Power

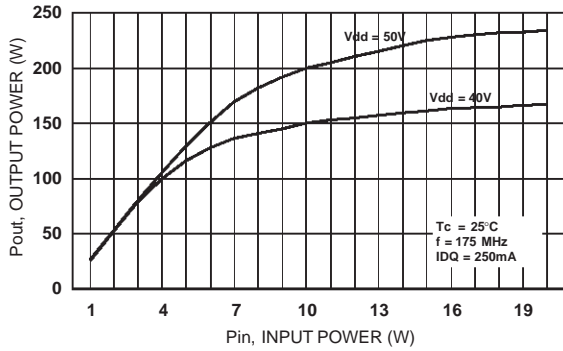

Output Power vs Input Power

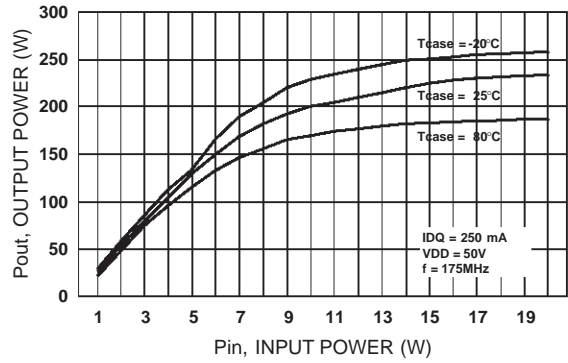

Output Power vs Supply Voltage

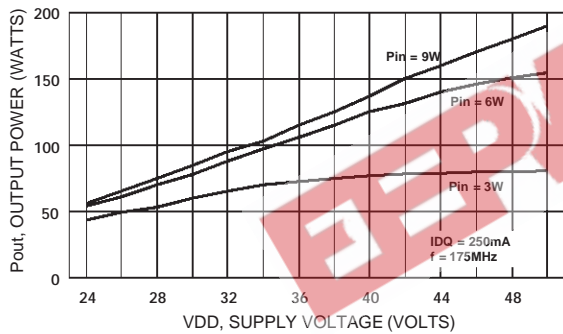

Output Power vs Gate Voltage

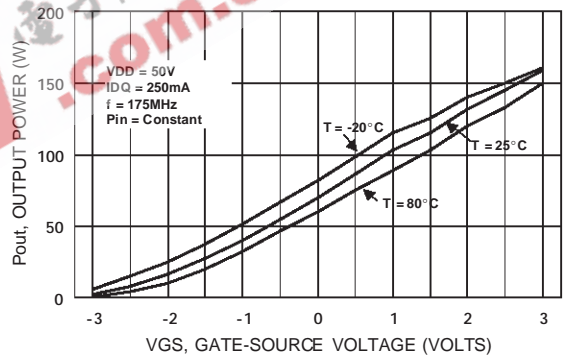

Capacitance vs Drain-Source Voltage

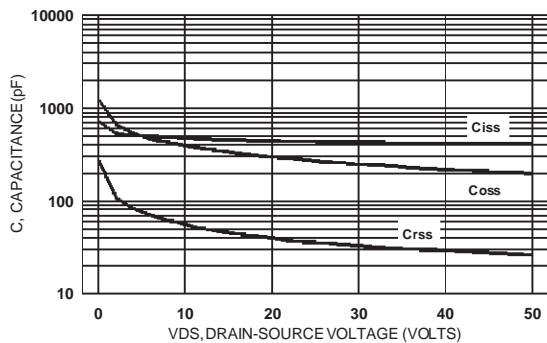

Drain Current vs Gate Voltage

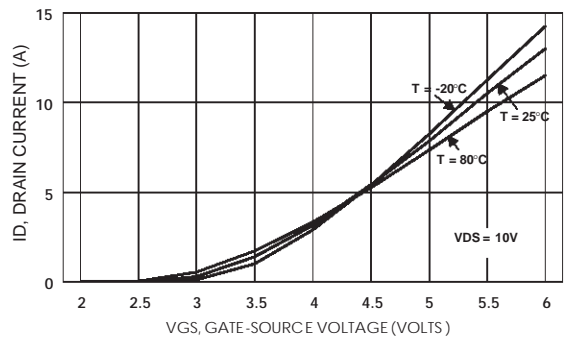

TYPICAL PERFORMANCE

Gate-Source Voltages vs Case Temperature

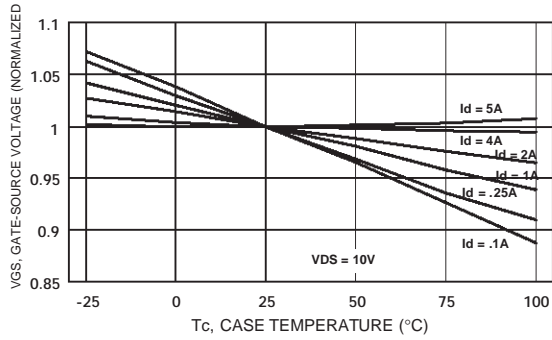

Output Power vs Gate Voltage

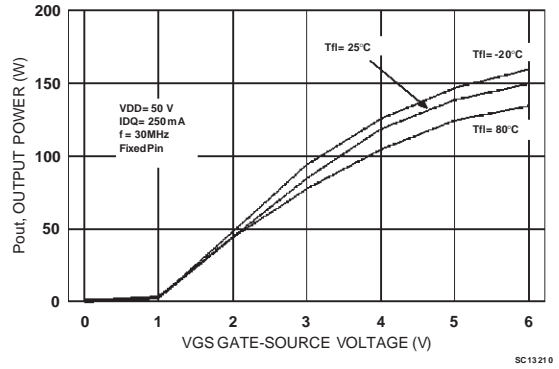

Power Gain vs Output Power

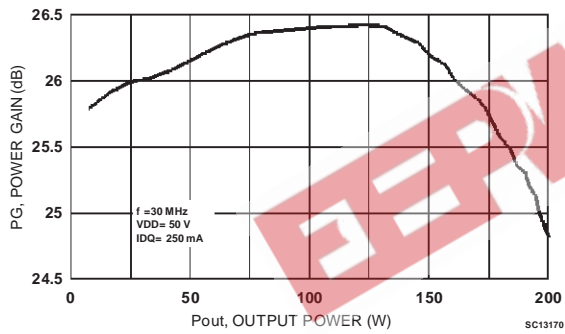

Output Power vs Input Power

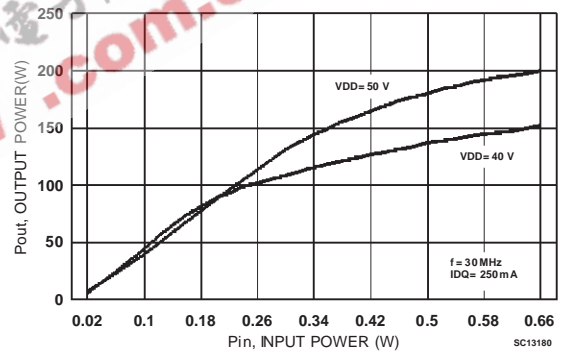

Efficiency vs Output Power

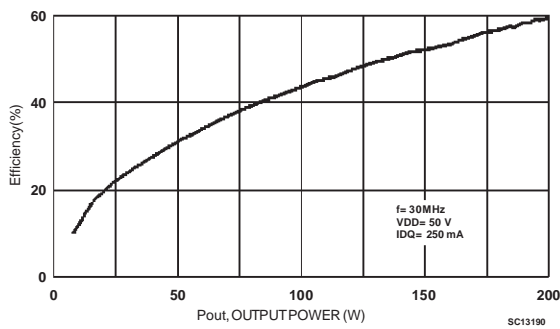

Output Power vs Voltage Supply

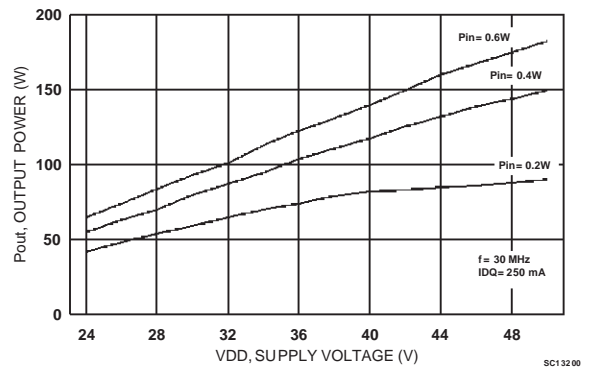

Maximum Thermal Resistance vs Case Temperature

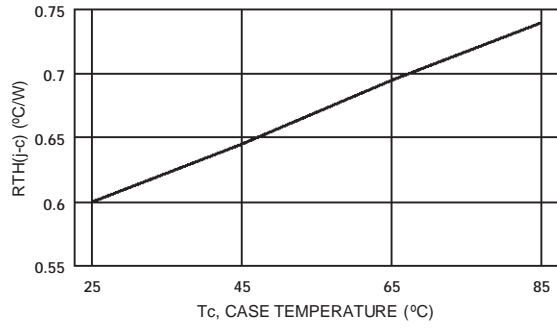

DC Safe Operating Area

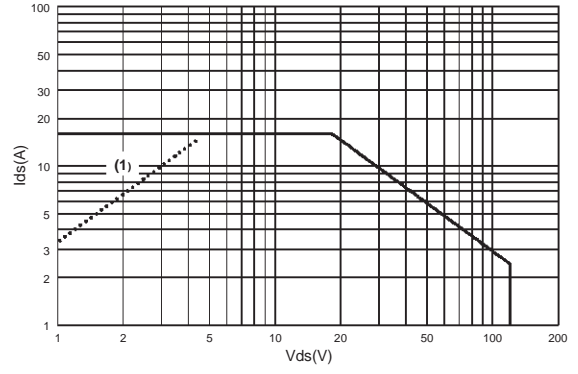

EEPW 电子产品世界 .com.cn

30 MHz Test Circuit Schematic (Engineering Test Circuit)

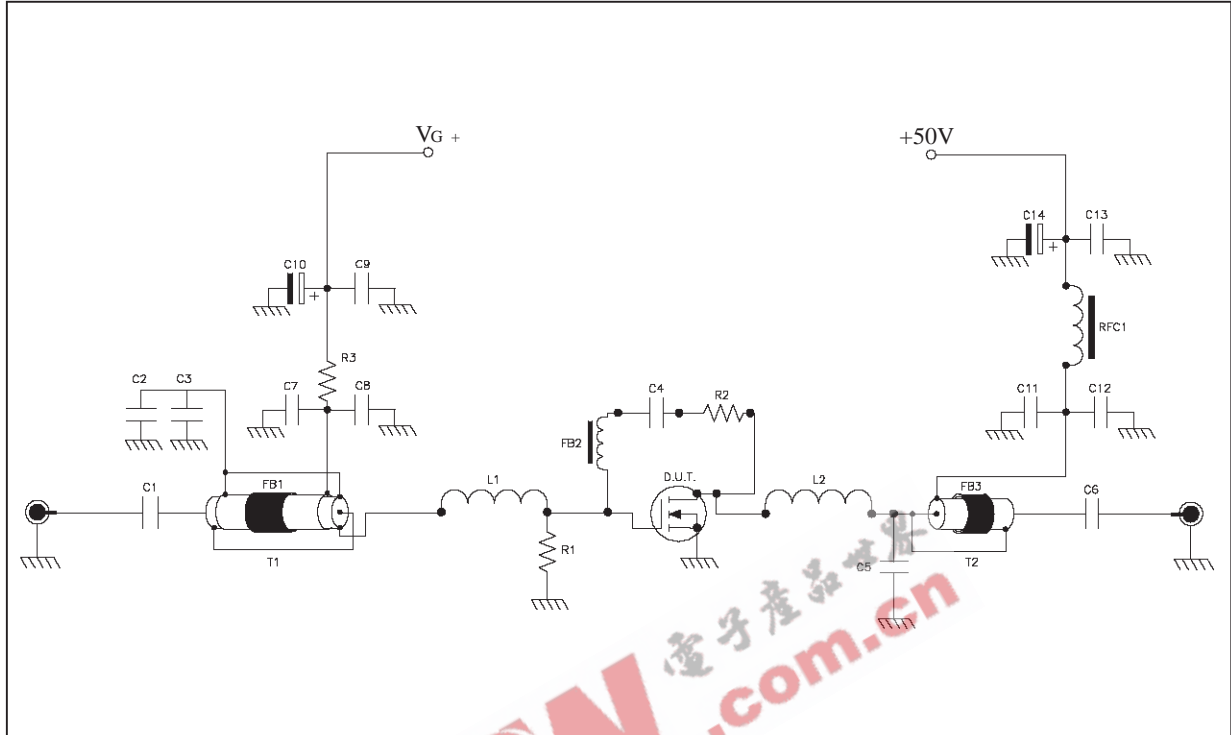

30 MHz Test Circuit Component Part List

T1	9:1 Transformer, 25 ohm Flexible Coax with extra shield .090 OD 15" Long		
T2	1:4 Transformer, 50 ohm Flexible Coax .225 OD 15" Long		
FB1	Toroid, 1.7" OD .30" ID 220u 4 Turns		
FB2	Surface Mount EMI Shield Bead		
FB3	Toroid, 1.7" OD .300" ID 220u 3 Turns		
RFC1	Toroid, 0.5" OD 0.30" ID, 125u 4 turns 12 awg wire		
PCB	0.062" Woven Fiberglass, 1 oz. Copper, 2 Sides, er = 2.55		
C1, C4, C6, C7, C8,	0.01 uF ATC Chip Cap	C5	470 pF ATC Chip Cap
C9, C11, C12, C13	0.01 uF ATC Chip Cap	C10	10 uF 63V Electrolytic Capacitor
C2, C3	750 pF ATC Chip Cap	C14	100 uF 63V Electrolytic Capacitor
R1, R3	1K ohm 1W Chip Resistor	R2	680 ohm 3W Wirewound Resistor

## 175 MHz Test Circuit Schematic (Production Test Circuit)

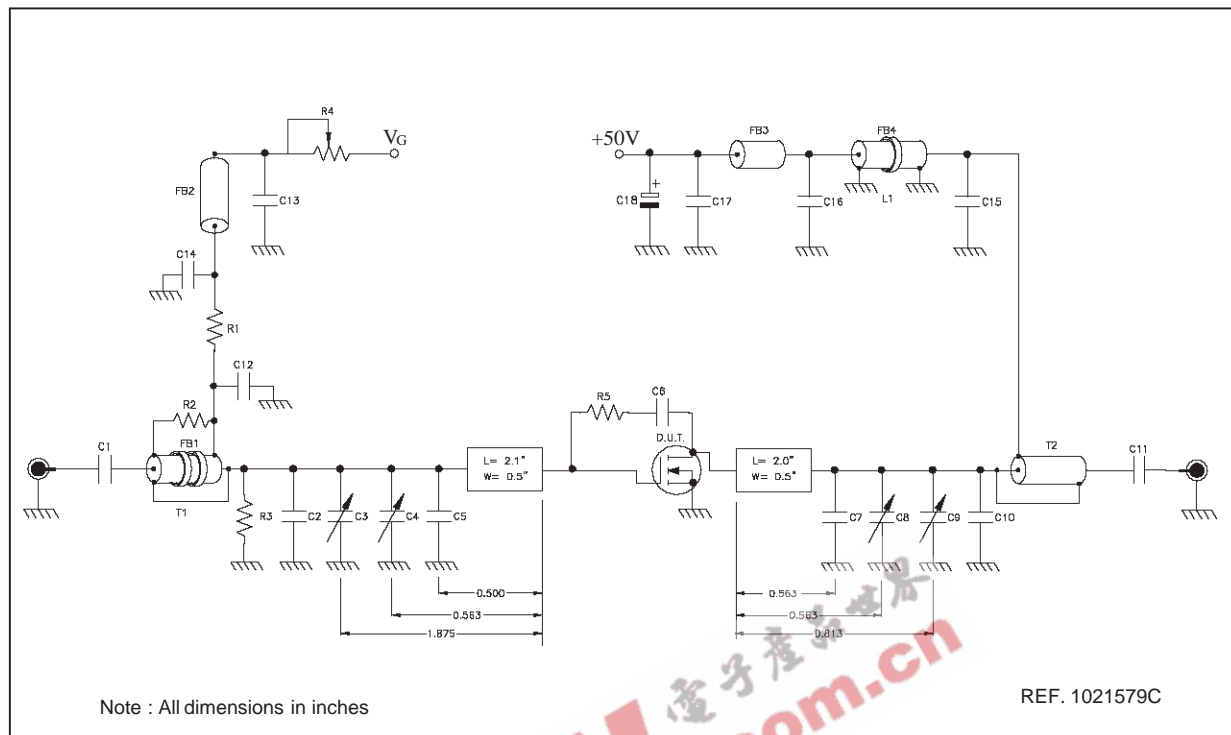

## 175 MHz Test Circuit Component Part List

T1	4:1 Transformer, 25 ohm Flexible Coax .090 OD 6 " Long	
T2	1:4 Transformer, 25 ohm Semi-Rigid Coax .141 OD 6 " Long	
FB1	Toroid X2, 0.5" OD .312" ID 850u 2 Turns	
FB2, FB3	VK200	
FB4	Shield Bead, 1" OD 0.5" ID 850u 3 Turns	
L1	1/4Wave Choke, 50 ohm Semi-Rigid Coax .141 OD 12 " Long	
PCB	0.062" Woven Fiberglass, 1 oz. Copper, 2 Sides, er = 2.55	
R1, R3	470 ohm 1W Chip Resistor	R4 20K ohm 10 Turn Potentiometer
R2	360 ohm 1/2W Resistor	R5 560 ohm 1W Resistor
C1, C11	470 pF ATC Chip Cap	C7 30 pF ATC Chip Cap
C2	43 pF ATC Chip Cap	C10 91 pF ATC Chip Cap
C3, C8, C9	Arco 404, 12-65 pF	C12, C15 1200 pF ATC Chip Cap
C4	Arco 423, 16-100 pF	C13, C14 0.01 uF / 500V Chip Cap
C5	120 pF ATC Chip Cap	C16, C17 0.01 uF / 500V Chip Cap
C6	0.01 uF ATC Chip Cap	C18 10 uF 63V Electrolytic Capacitor

175 MHz Test Circuit Photomaster

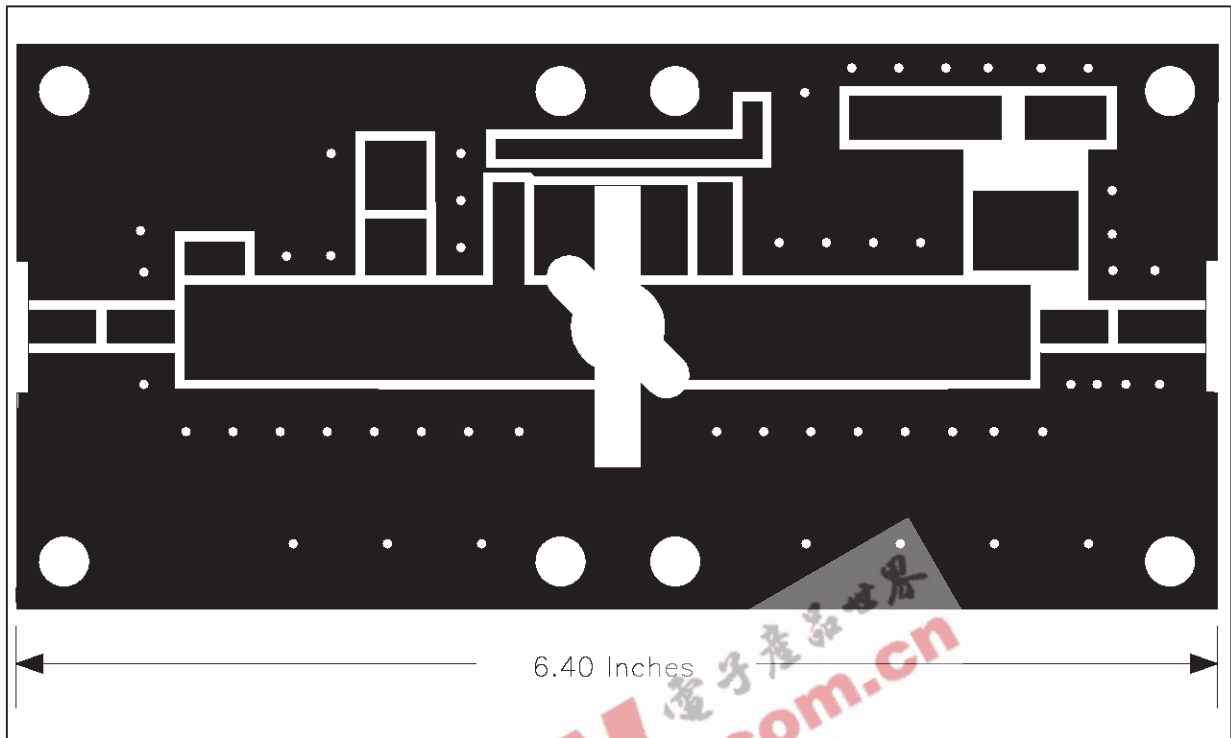

175 MHz Test Circuit

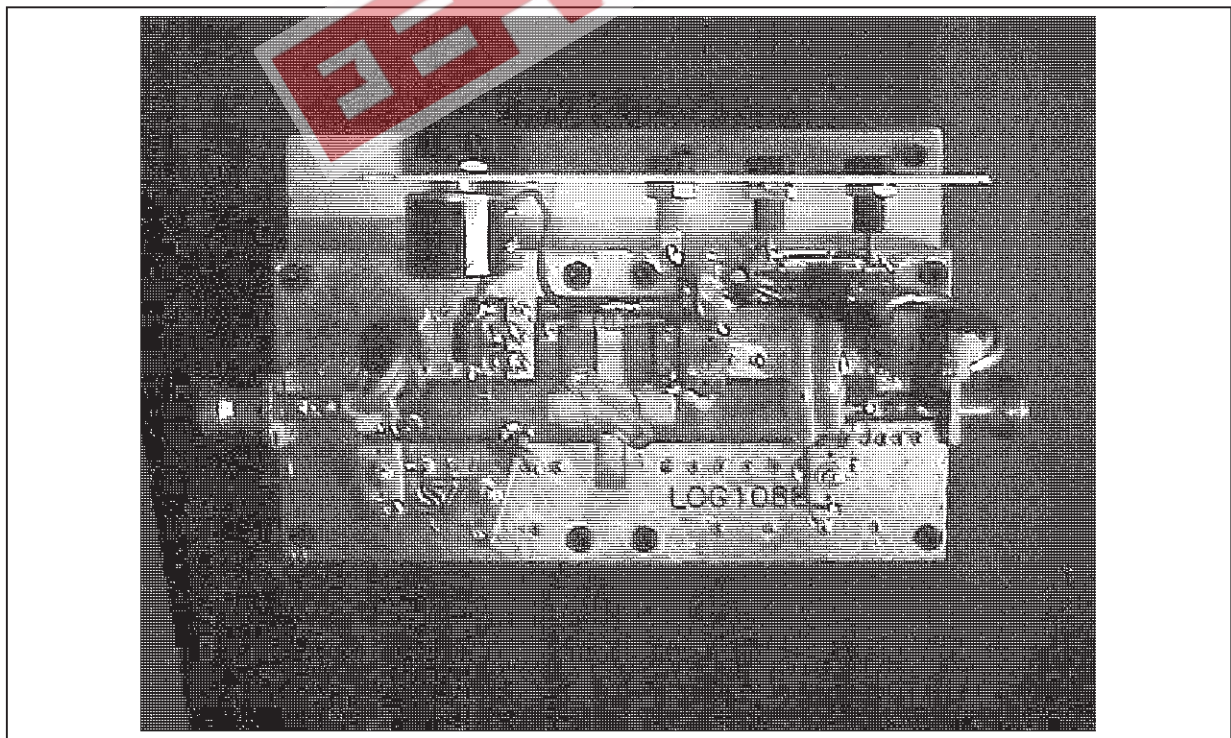



**M174 (.500 DIA 4L N/HERM W/FLG) MECHANICAL DATA**

DIM.	mm			inch		
	MIN.	TYP.	MAX.	MIN.	TYP.	MAX.
A	5.56		5.84	0.219		0.230
B		3.18			0.125	
C	6.22		6.48	0.245		0.255
D	18.28		18.54	0.720		0.730
E		3.18			0.125	
F	24.64		24.89	0.970		0.980
G	12.57		12.83	0.495		0.505
H	0.08		0.18	0.003		0.007
I	2.11		3.00	0.083		0.118
J	3.81		4.45	0.150		0.175
K			7.11			0.280
L	25.53		26.67	1.005		1.050
M	3.05		3.30	0.120		0.130

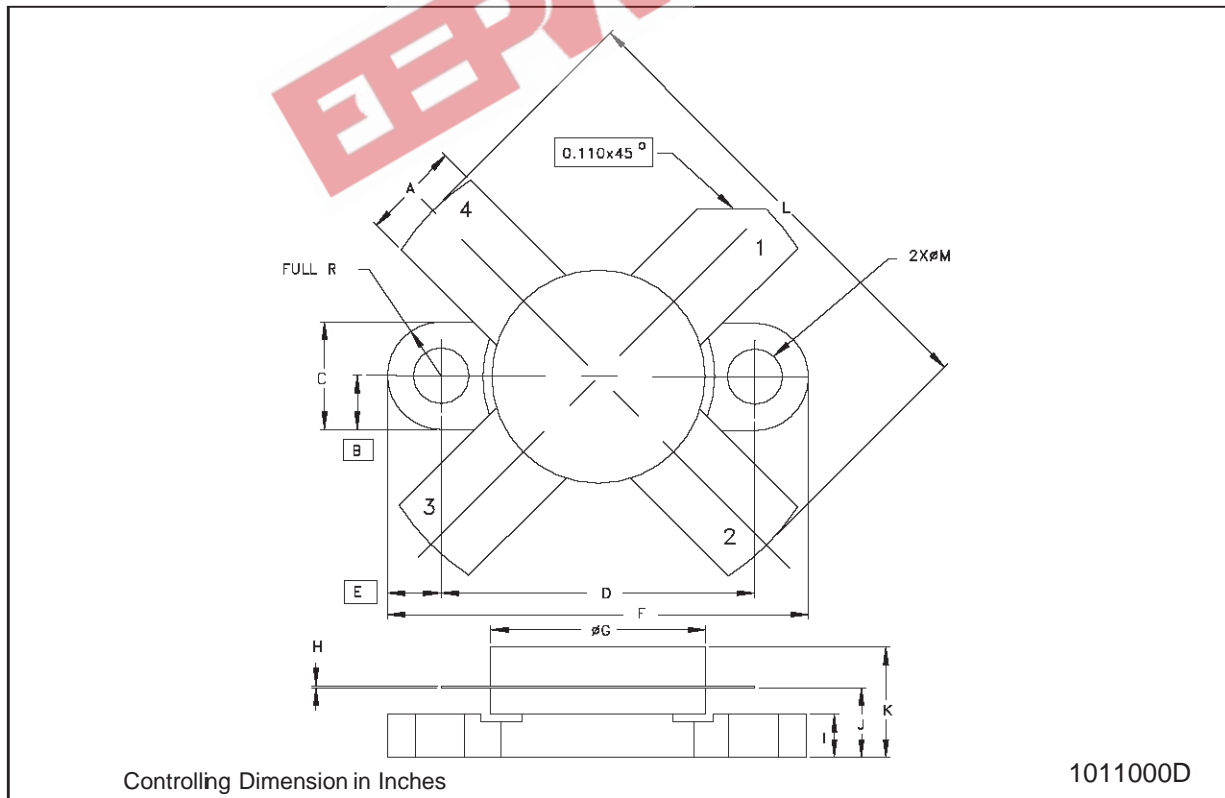



Information furnished is believed to be accurate and reliable. However, STMicroelectronics assumes no responsibility for the consequences of use of such information nor for any infringement of patents or other rights of third parties which may result from its use. No license is granted by implication or otherwise under any patent or patent rights of STMicroelectronics. Specification mentioned in this publication are subject to change without notice. This publication supersedes and replaces all information previously supplied. STMicroelectronics products are not authorized for use as critical components in life support devices or systems without express written approval of STMicroelectronics.

The ST logo is a trademark of STMicroelectronics

© 1999 STMicroelectronics – Printed in Italy – All Rights Reserved

STMicroelectronics GROUP OF COMPANIES

Australia - Brazil - China - Finland - France - Germany - Hong Kong - India - Italy - Japan - Malaysia - Malta - Morocco - Singapore - Spain - Sweden - Switzerland - United Kingdom - U.S.A.

<http://www.st.com>