



# Dual Bipolar/JFET, Audio Operational Amplifier

## OP275\*

### FEATURES

Excellent Sonic Characteristics

Low Noise: 6 nV/ $\sqrt{\text{Hz}}$

Low Distortion: 0.0006%

High Slew Rate: 22 V/ $\mu\text{s}$

Wide Bandwidth: 9 MHz

Low Supply Current: 5 mA

Low Offset Voltage: 1 mV

Low Offset Current: 2 nA

Unity Gain Stable

SOIC-8 Package

### APPLICATIONS

High Performance Audio

Active Filters

Fast Amplifiers

Integrators

### GENERAL DESCRIPTION

The OP275 is the first amplifier to feature the Butler Amplifier front-end. This new front-end design combines both bipolar and JFET transistors to attain amplifiers with the accuracy and low noise performance of bipolar transistors, and the speed and sound quality of JFETs. Total Harmonic Distortion plus Noise equals that of previous audio amplifiers, but at much lower supply currents.

A very low  $1/f$  corner of below 6 Hz maintains a flat noise density response. Whether noise is measured at either 30 Hz or 1 kHz, it is only 6 nV/ $\sqrt{\text{Hz}}$ . The JFET portion of the input stage gives the OP275 its high slew rates to keep distortion low, even when large output swings are required, and the 22 V/ $\mu\text{s}$  slew rate of the OP275 is the fastest of any standard audio amplifier. Best of all, this low noise and high speed are accomplished using less than 5 mA of supply current, lower than any standard audio amplifier.

### PIN CONNECTIONS

8-Lead Narrow-Body SO  
(S Suffix)

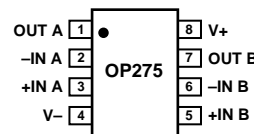

8-Lead Epoxy DIP  
(P Suffix)

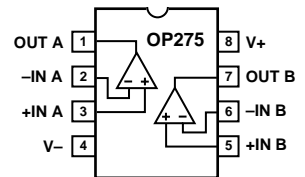

Improved dc performance is also provided with bias and offset currents greatly reduced over purely bipolar designs. Input offset voltage is guaranteed at 1 mV and is typically less than 200  $\mu\text{V}$ . This allows the OP275 to be used in many dc coupled or summing applications without the need for special selections or the added noise of additional offset adjustment circuitry.

The output is capable of driving 600  $\Omega$  loads to 10 V rms while maintaining low distortion. THD + Noise at 3 V rms is a low 0.0006%.

The OP275 is specified over the extended industrial ( $-40^{\circ}\text{C}$  to  $+85^{\circ}\text{C}$ ) temperature range. OP275s are available in both plastic DIP and SOIC-8 packages. SOIC-8 packages are available in 2500 piece reels. Many audio amplifiers are not offered in SOIC-8 surface mount packages for a variety of reasons; however, the OP275 was designed so that it would offer full performance in surface mount packaging.

\*Protected by U.S. Patent No. 5,101,126.

### REV. A

Information furnished by Analog Devices is believed to be accurate and reliable. However, no responsibility is assumed by Analog Devices for its use, nor for any infringements of patents or other rights of third parties which may result from its use. No license is granted by implication or otherwise under any patent or patent rights of Analog Devices.

© Analog Devices, Inc., 1995

One Technology Way, P.O. Box 9106, Norwood, MA 02062-9106, U.S.A.  
Tel: 617/329-4700 Fax: 617/326-8703

# OP275—SPECIFICATIONS

## ELECTRICAL CHARACTERISTICS (@ $V_S = \pm 15.0\text{ V}$ , $T_A = +25^\circ\text{C}$ unless otherwise noted)

Parameter	Symbol	Conditions	Min	Typ	Max	Units
<b>AUDIO PERFORMANCE</b>						
THD + Noise		$V_{IN} = 3\text{ V rms}$ , $R_L = 2\text{ k}\Omega$ , $f = 1\text{ kHz}$		0.006		%
Voltage Noise Density	$e_n$	$f = 30\text{ Hz}$		7		$\text{nV}/\sqrt{\text{Hz}}$
Current Noise Density	$i_n$	$f = 1\text{ kHz}$		6		$\text{nV}/\sqrt{\text{Hz}}$
Headroom		THD + Noise $\leq 0.01\%$ , $R_L = 2\text{ k}\Omega$ , $V_S = \pm 18\text{ V}$		1.5		$\text{pA}/\sqrt{\text{Hz}}$
				>12.9		dBu
<b>INPUT CHARACTERISTICS</b>						
Offset Voltage	$V_{OS}$	$-40^\circ\text{C} \leq T_A \leq +85^\circ\text{C}$			1	mV
Input Bias Current	$I_B$	$V_{CM} = 0\text{ V}$		100	350	nA
Input Offset Current	$I_{OS}$	$V_{CM} = 0\text{ V}$ , $-40^\circ\text{C} \leq T_A \leq +85^\circ\text{C}$		100	400	nA
Input Voltage Range	$V_{CM}$	$V_{CM} = 0\text{ V}$	-10.5			V
Common-Mode Rejection Ratio	CMRR	$V_{CM} = 0\text{ V}$ , $-40^\circ\text{C} \leq T_A \leq +85^\circ\text{C}$		2	100	nA
Large Signal Voltage Gain	$A_{VO}$	$V_{CM} = \pm 10.5\text{ V}$ , $-40^\circ\text{C} \leq T_A \leq +85^\circ\text{C}$	80	106		dB
		$R_L = 2\text{ k}\Omega$	250			V/mV
		$R_L = 2\text{ k}\Omega$ , $-40^\circ\text{C} \leq T_A \leq +85^\circ\text{C}$	175			V/mV
		$R_L = 600\ \Omega$		200		V/mV
Offset Voltage Drift	$\Delta V_{OS}/\Delta T$			2		$\mu\text{V}/^\circ\text{C}$
<b>OUTPUT CHARACTERISTICS</b>						
Output Voltage Swing	$V_O$	$R_L = 2\text{ k}\Omega$	-13.5	$\pm 13.9$	+13.5	V
		$R_L = 2\text{ k}\Omega$ , $-40^\circ\text{C} \leq T_A \leq +85^\circ\text{C}$	-13	$\pm 13.9$	+13	V
		$R_L = 600\ \Omega$ , $V_S = \pm 18\text{ V}$		+14, -16		V
<b>POWER SUPPLY</b>						
Power Supply Rejection Ratio	PSRR	$V_S = \pm 4.5\text{ V to } \pm 18\text{ V}$	85	111		dB
Supply Current	$I_{SY}$	$V_S = \pm 4.5\text{ V to } \pm 18\text{ V}$ , $-40^\circ\text{C} \leq T_A \leq +85^\circ\text{C}$	80			dB
		$V_S = \pm 4.5\text{ V to } \pm 18\text{ V}$ , $V_O = 0\text{ V}$ , $R_L = \infty$ , $-40^\circ\text{C} \leq T_A \leq +85^\circ\text{C}$		4	5	mA
		$V_S = \pm 22\text{ V}$ , $V_O = 0\text{ V}$ , $R_L = \infty$ , $-40^\circ\text{C} \leq T_A \leq +85^\circ\text{C}$			5.5	mA
Supply Voltage Range	$V_S$		$\pm 4.5$		$\pm 22$	V
<b>DYNAMIC PERFORMANCE</b>						
Slew Rate	SR	$R_L = 2\text{ k}\Omega$	15	22		V/ $\mu\text{s}$
Full-Power Bandwidth	$BW_P$					kHz
Gain Bandwidth Product	GBP			9		MHz
Phase Margin	$\phi_m$			62		Degrees
Overshoot Factor		$V_{IN} = 100\text{ mV}$ , $A_V = +1$ , $R_L = 600\ \Omega$ , $C_L = 100\text{ pF}$		10		%

Specifications subject to change without notice.

**WAFER TEST LIMITS** (@  $V_S = \pm 15.0\text{ V}$ ,  $T_A = +25^\circ\text{C}$  unless otherwise noted)

Parameter	Symbol	Conditions	Limit	Units
Offset Voltage	$V_{OS}$		1	mV max
Input Bias Current	$I_B$	$V_{CM} = 0\text{ V}$	350	nA max
Input Offset Current	$I_{OS}$	$V_{CM} = 0\text{ V}$	50	nA max
Input Voltage Range <sup>1</sup>	$V_{CM}$		$\pm 10.5$	V min
Common-Mode Rejection Ratio	CMRR	$V_{CM} = \pm 10.5\text{ V}$	80	dB min
Power Supply Rejection Ratio	PSRR	$V = \pm 4.5\text{ V to } \pm 18\text{ V}$	85	dB min
Large Signal Voltage Gain	$A_{VO}$	$R_L = 2\text{ k}\Omega$	250	V/mV min
Output Voltage Range	$V_O$	$R_L = 10\text{ k}\Omega$	$\pm 13.5$	V min
Supply Current	$I_{SY}$	$V_O = 0\text{ V}$ , $R_L = \infty$	5	mA max

NOTES

Electrical tests and wafer probe to the limits shown. Due to variations in assembly methods and normal yield loss, yield after packaging is not guaranteed for standard product dice. Consult factory to negotiate specifications based on dice lot qualifications through sample lot assembly and testing.

<sup>1</sup>Guaranteed by CMRR test.

Specifications subject to change without notice.

**ABSOLUTE MAXIMUM RATINGS<sup>1</sup>**

- Supply Voltage . . . . .  $\pm 22\text{ V}$
- Input Voltage<sup>2</sup> . . . . .  $\pm 22\text{ V}$
- Differential Input Voltage<sup>2</sup> . . . . .  $\pm 7.5\text{ V}$
- Output Short-Circuit Duration to GND<sup>3</sup> . . . . . Indefinite
- Storage Temperature Range
- P, S Package . . . . .  $-65^\circ\text{C to } +150^\circ\text{C}$
- Operating Temperature Range
- OP275G . . . . .  $-40^\circ\text{C to } +85^\circ\text{C}$
- Junction Temperature Range
- P, S Package . . . . .  $-65^\circ\text{C to } +150^\circ\text{C}$
- Lead Temperature Range (Soldering, 60 sec) . . . . .  $+300^\circ\text{C}$

Package Type	$\theta_{JA}$ <sup>4</sup>	$\theta_{JC}$	Units
8-Pin Plastic DIP (P)	103	43	$^\circ\text{C/W}$
8-Pin SOIC (S)	158	43	$^\circ\text{C/W}$

NOTES

<sup>1</sup>Absolute maximum ratings apply to both DICE and packaged parts, unless otherwise noted.

<sup>2</sup>For supply voltages greater than  $\pm 22\text{ V}$ , the absolute maximum input voltage is equal to the supply voltage.

<sup>3</sup>Shorts to either supply may destroy the device. See data sheet for full details.

<sup>4</sup> $\theta_{JA}$  is specified for the worst case conditions, i.e.,  $\theta_{JA}$  is specified for device in socket for cerdip, P-DIP, and LCC packages;  $\theta_{JA}$  is specified for device soldered in circuit board for SOIC package.

**ORDERING GUIDE**

Model	Temperature Range	Package Option
OP275GP	$-40^\circ\text{C to } +85^\circ\text{C}$	8-Pin Plastic DIP
OP275GS	$-40^\circ\text{C to } +85^\circ\text{C}$	8-Pin SOIC
OP275GSR	$-40^\circ\text{C to } +85^\circ\text{C}$	SO-8 Reel, 2500 pcs.
OP275GBC	$+25^\circ\text{C}$	DICE

**DICE CHARACTERISTICS**

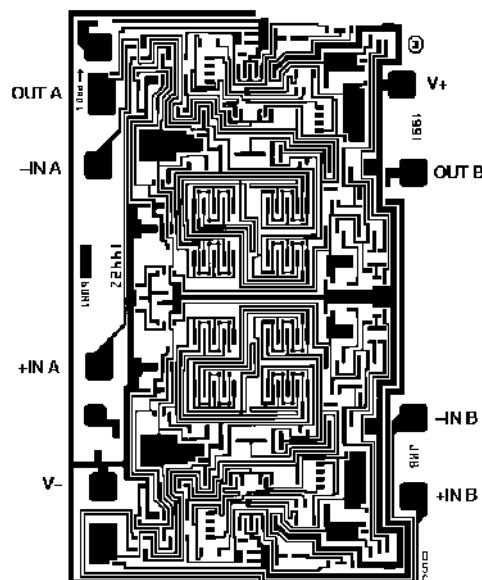

Die Size  $0.070 \times 0.108\text{ in.}$  (7,560 sq. mils)  
Substrate is connected to V-

**CAUTION**

ESD (electrostatic discharge) sensitive device. Electrostatic charges as high as 4000 V readily accumulate on the human body and test equipment and can discharge without detection. Although the OP275 features proprietary ESD protection circuitry, permanent damage may occur on devices subjected to high energy electrostatic discharges. Therefore, proper ESD precautions are recommended to avoid performance degradation or loss of functionality.



# OP275—Typical Performance Curves

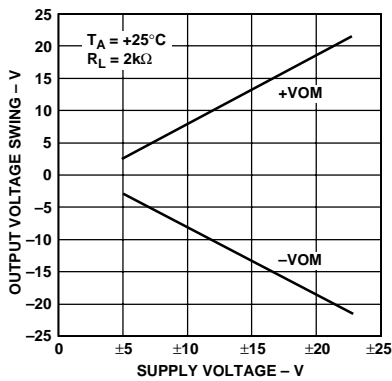

Output Voltage Swing vs. Supply Voltage

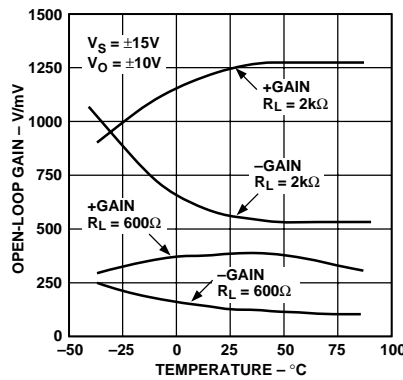

Open-Loop Gain vs. Temperature

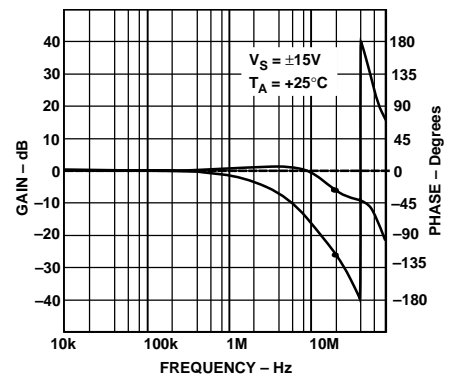

Closed-Loop Gain and Phase,  $A_V = +1$

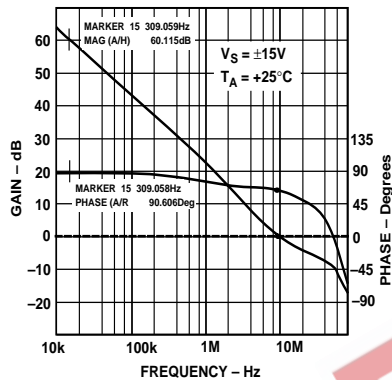

Open-Loop Gain, Phase vs. Frequency

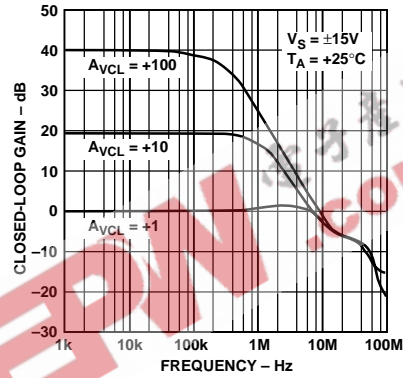

Closed-Loop Gain vs. Frequency

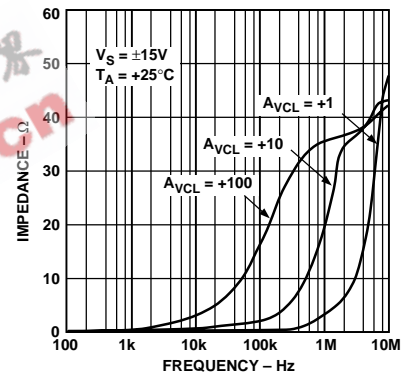

Closed-Loop Output Impedance vs. Frequency

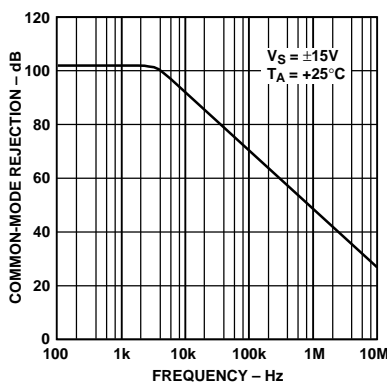

Common-Mode Rejection vs. Frequency

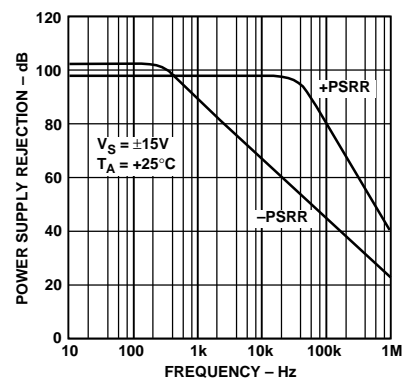

Power Supply Rejection vs. Frequency

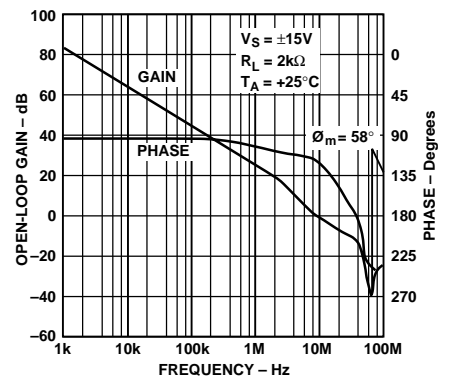

Open-Loop Gain, Phase vs. Frequency

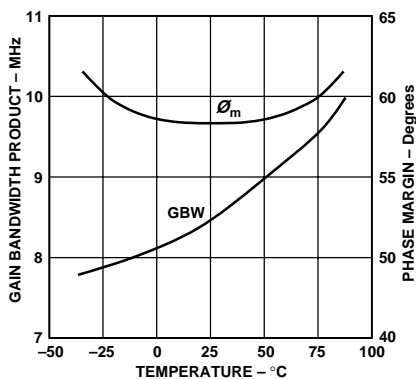

Gain Bandwidth Product, Phase Margin vs. Temperature

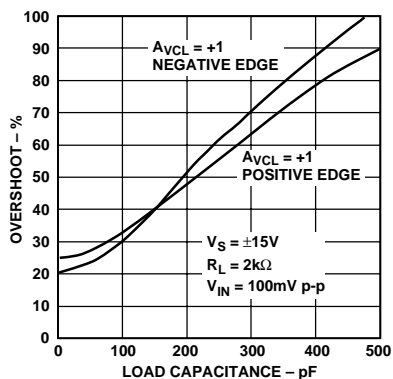

Small-Signal Overshoot vs. Load Capacitance

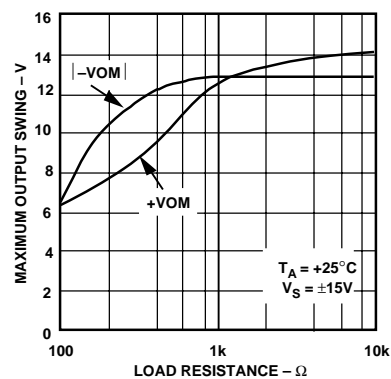

Maximum Output Voltage vs. Load Resistance

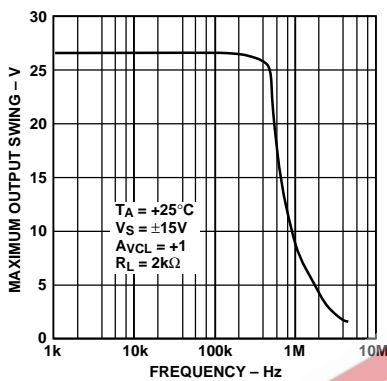

Maximum Output Swing vs. Frequency

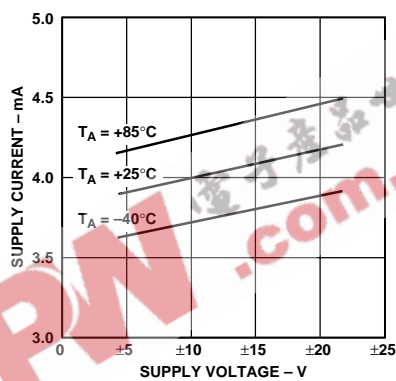

Supply Current vs. Supply Voltage

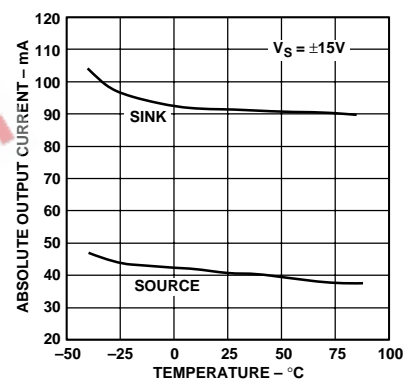

Short Circuit Current vs. Temperature

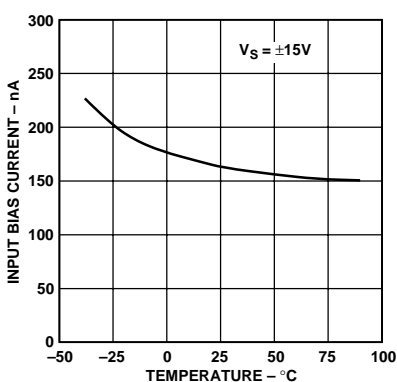

Input Bias Current vs. Temperature

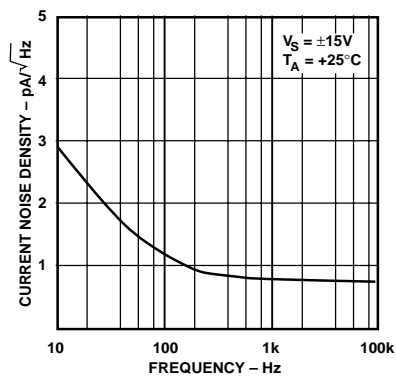

Current Noise Density vs. Frequency

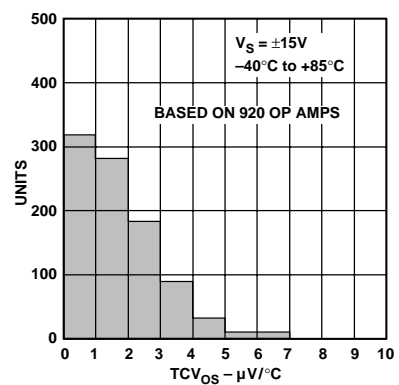

TCV<sub>OS</sub> Distribution

# OP275—Typical Performance Curves

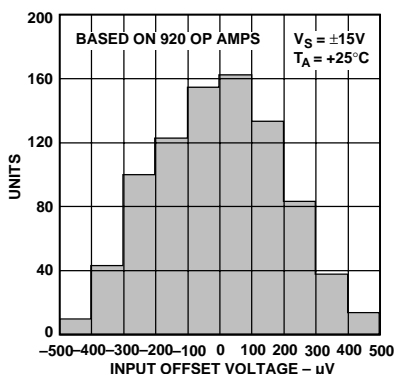

Input Offset ( $V_{OS}$ ) Distribution

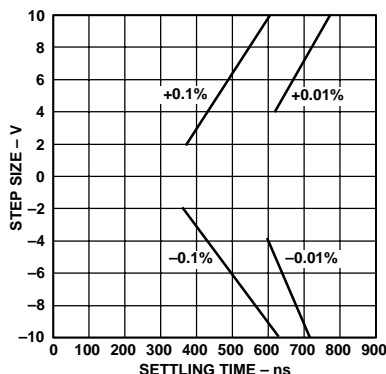

Settling Time vs. Step Size

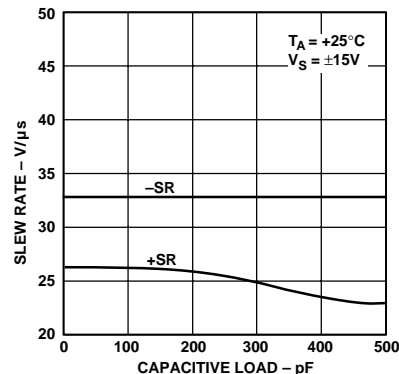

Slew Rate vs. Capacitive Load

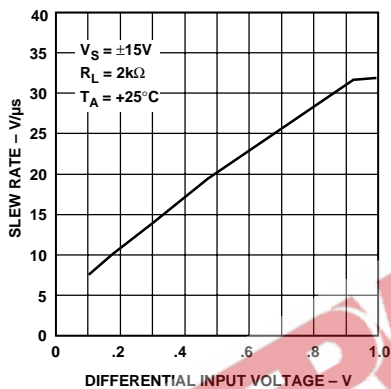

Slew Rate vs. Differential Input Voltage

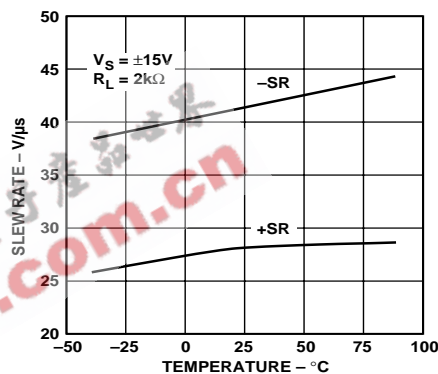

Slew Rate vs. Temperature

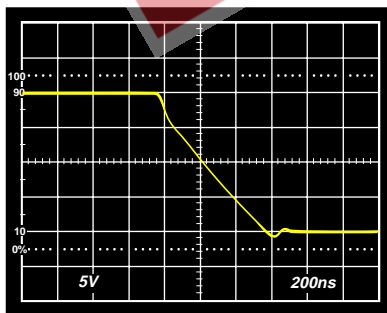

Negative Slew Rate  
 $R_L = 2\text{ k}\Omega$ ,  $V_S = \pm 15\text{ V}$ ,  $A_V = +1$

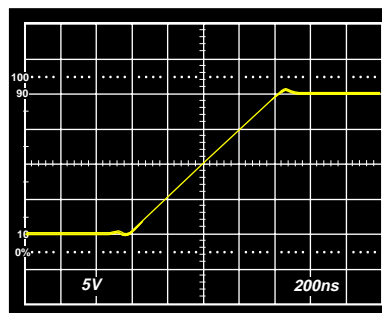

Positive Slew Rate  
 $R_L = 2\text{ k}\Omega$ ,  $V_S = \pm 15\text{ V}$ ,  $A_V = +1$

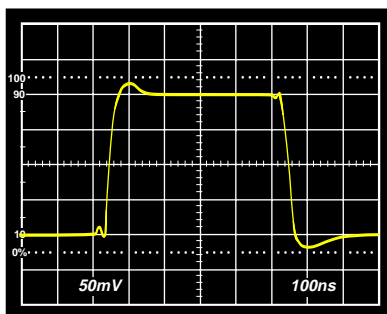

Small Signal Response  
 $R_L = 2\text{ k}\Omega$ ,  $V_S = \pm 15\text{ V}$ ,  $A_V = +1$

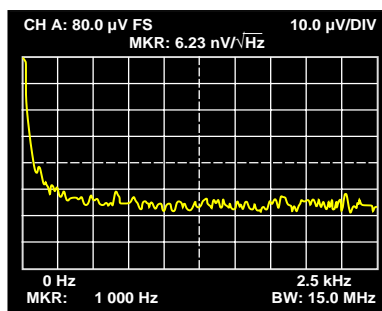

Voltage Noise Density vs. Frequency  
 $V_S = \pm 15\text{ V}$

**APPLICATIONS**

**Short Circuit Protection**

The OP275 has been designed with inherent short circuit protection to ground. An internal 30 Ω resistor, in series with the output, limits the output current at room temperature to  $I_{SC+} = 40$  mA and  $I_{SC-} = -90$  mA, typically, with ±15 V supplies.

However, shorts to either supply may destroy the device when excessive voltages or currents are applied. If it is possible for a user to short an output to a supply, for safe operation, the output current of the OP275 should be design-limited to ±30 mA, as shown in Figure 1.

**Total Harmonic Distortion**

Total Harmonic Distortion + Noise (THD + N) of the OP275 is well below 0.001% with any load down to 600 Ω. However, this is dependent upon the peak output swing. In Figure 2 it is seen that the THD + Noise with 3 V rms output is below 0.001%. In the following Figure 3, THD + Noise is below 0.001% for the 10 kΩ and 2 kΩ loads but increases to above 0.1% for the 600 Ω load condition. This is a result of the output swing capability of the OP275. Notice the results in Figure 4, showing THD vs.  $V_{IN}$  (V rms). This figure shows that the THD + Noise remains very low until the output reaches 9.5 volts rms. This performance is similar to competitive products.

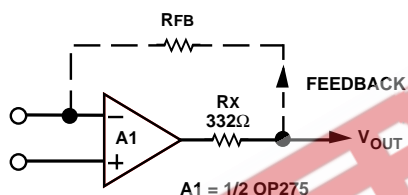

Figure 1. Recommended Output Short Circuit Protection

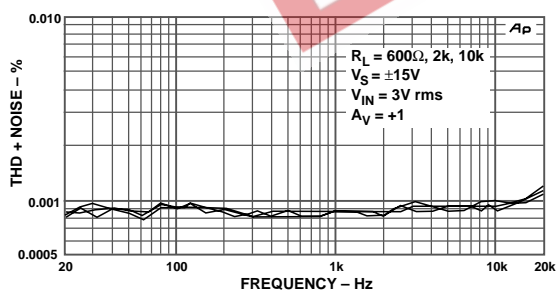

Figure 2. THD + Noise vs. Frequency vs.  $R_{LOAD}$

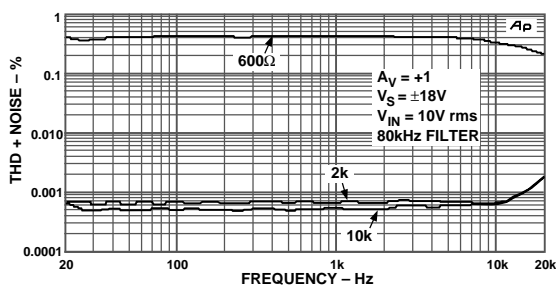

Figure 3. THD + Noise vs.  $R_{LOAD}$ ;  $V_{IN} = 10$  V rms, ±18 V Supplies

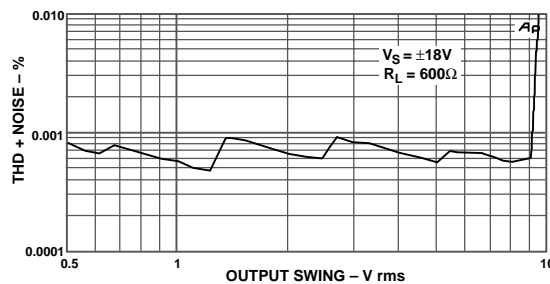

Figure 4. Headroom, THD + Noise vs. Output Amplitude (V rms);  $R_{LOAD} = 600$  Ω,  $V_{SUP} = ±18$  V

The output of the OP275 is designed to maintain low harmonic distortion while driving 600 Ω loads. However, driving 600 Ω loads with very high output swings results in higher distortion if clipping occurs. A common example of this is in attempting to drive 10 V rms into any load with ±15 volt supplies. Clipping will occur and distortion will be very high.

To attain low harmonic distortion with large output swings, supply voltages may be increased. Figure 5 shows the performance of the OP275 driving 600 Ω loads with supply voltages varying from ±18 volts to ±20 volts. Notice that with ±18 volt supplies the distortion is fairly high, while with ±20 volt supplies it is a very low 0.0007%.

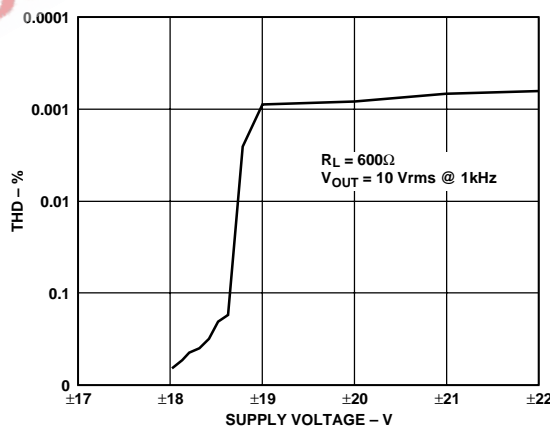

Figure 5. THD + Noise vs. Supply Voltage

**Noise**

The voltage noise density of the OP275 is below 7 nV/√Hz from 30 Hz. This enables low noise designs to have good performance throughout the full audio range. Figure 6 shows a typical OP275 with a 1/f noise corner at 2.24 Hz.

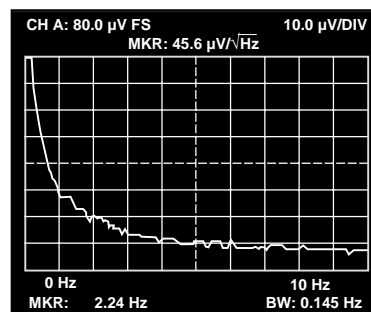

Figure 6. 1/f Noise Corner,  $V_S = ±15$  V,  $A_V = 1000$

# OP275

## Noise Testing

For audio applications the noise density is usually the most important noise parameter. For characterization the OP275 is tested using an Audio Precision, System One. The input signal to the Audio Precision must be amplified enough to measure it accurately. For the OP275 the noise is gained by approximately 1020 using the circuit shown in Figure 7. Any readings on the Audio Precision must then be divided by the gain. In implementing this test fixture, good supply bypassing is essential.

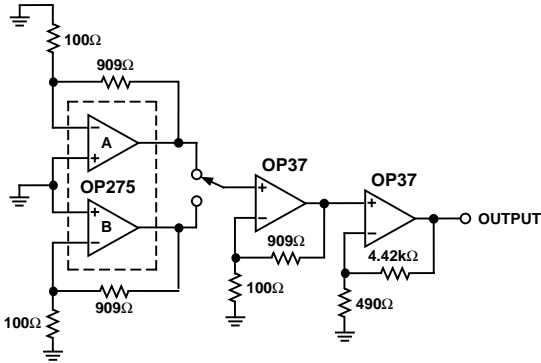

Figure 7. Noise Test Fixture

## Input Overcurrent Protection

The maximum input differential voltage that can be applied to the OP275 is determined by a pair of internal Zener diodes connected across its inputs. They limit the maximum differential input voltage to  $\pm 7.5$  V. This is to prevent emitter-base junction breakdown from occurring in the input stage of the OP275 when very large differential voltages are applied. However, in order to preserve the OP275's low input noise voltage, internal resistances in series with the inputs were not used to limit the current in the clamp diodes. In small signal applications, this is not an issue; however, in applications where large differential voltages can be inadvertently applied to the device, large transient currents can flow through these diodes. Although these diodes have been designed to carry a current of  $\pm 5$  mA, external resistors as shown in Figure 8 should be used in the event that the OP275's differential voltage were to exceed  $\pm 7.5$  V.

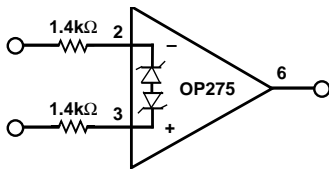

Figure 8. Input Overcurrent Protection

## Output Voltage Phase Reversal

Since the OP275's input stage combines bipolar transistors for low noise and p-channel JFETs for high speed performance, the output voltage of the OP275 may exhibit phase reversal if either of its inputs exceed its negative common-mode input voltage. This might occur in very severe industrial applications where a sensor, or system, fault might apply very large voltages on the inputs of the OP275. Even though the input voltage range of the OP275 is  $\pm 10.5$  V, an input voltage of approximately  $-13.5$  V will cause output voltage phase reversal. In inverting amplifier configurations, the OP275's internal 7.5 V input clamping diodes will prevent phase reversal; however, they will not prevent

this effect from occurring in noninverting applications. For these applications, the fix is a simple one and is illustrated in Figure 9. A 3.92 k $\Omega$  resistor in series with the noninverting input of the OP275 cures the problem.

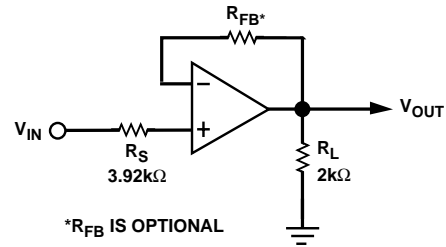

Figure 9. Output Voltage Phase Reversal Fix

## Overload, or Overdrive, Recovery

Overload, or overdrive, recovery time of an operational amplifier is the time required for the output voltage to recover to a rated output voltage from a saturated condition. This recovery time is important in applications where the amplifier must recover quickly after a large abnormal transient event. The circuit shown in Figure 10 was used to evaluate the OP275's overload recovery time. The OP275 takes approximately 1.2  $\mu$ s to recover to  $V_{OUT} = +10$  V and approximately 1.5  $\mu$ s to recover to  $V_{OUT} = -10$  V.

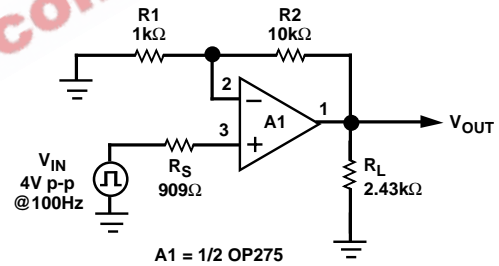

Figure 10. Overload Recovery Time Test Circuit

## Measuring Settling Time

The design of OP275 combines high slew rate and wide gain-bandwidth product to produce a fast-settling ( $t_s < 1$   $\mu$ s) amplifier for 8- and 12-bit applications. The test circuit designed to measure the settling time of the OP275 is shown in Figure 11. This test method has advantages over false-sum node techniques in that the actual output of the amplifier is measured, instead of an error voltage at the sum node. Common-mode settling effects are exercised in this circuit in addition to the slew rate and bandwidth effects measured by the false-sum-node method. Of course, a reasonably flat-top pulse is required as the stimulus.

The output waveform of the OP275 under test is clamped by Schottky diodes and buffered by the JFET source follower. The signal is amplified by a factor of ten by the OP260 and then Schottky-clamped at the output to prevent overloading the oscilloscope's input amplifier. The OP41 is configured as a fast integrator which provides overall dc offset nulling.

## High Speed Operation

As with most high speed amplifiers, care should be taken with supply decoupling, lead dress, and component placement. Recommended circuit configurations for inverting and noninverting applications are shown in Figures 12 and Figure 13.



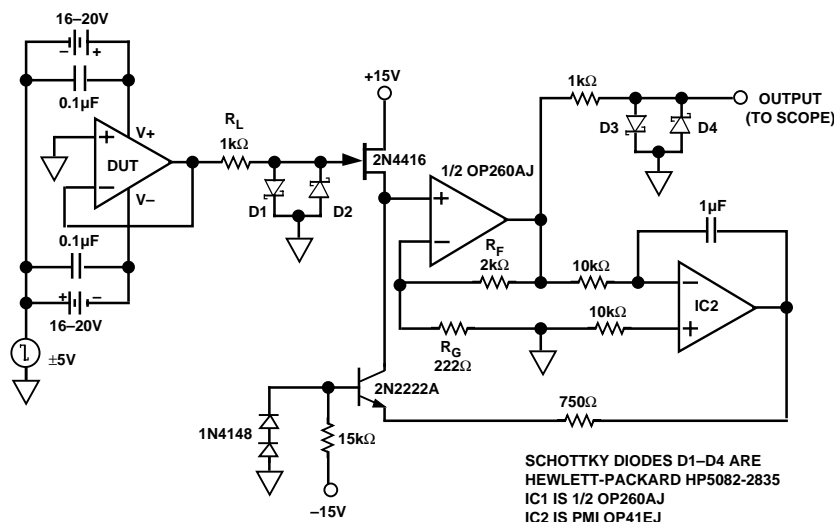

Figure 11. OP275's Settling Time Test Fixture

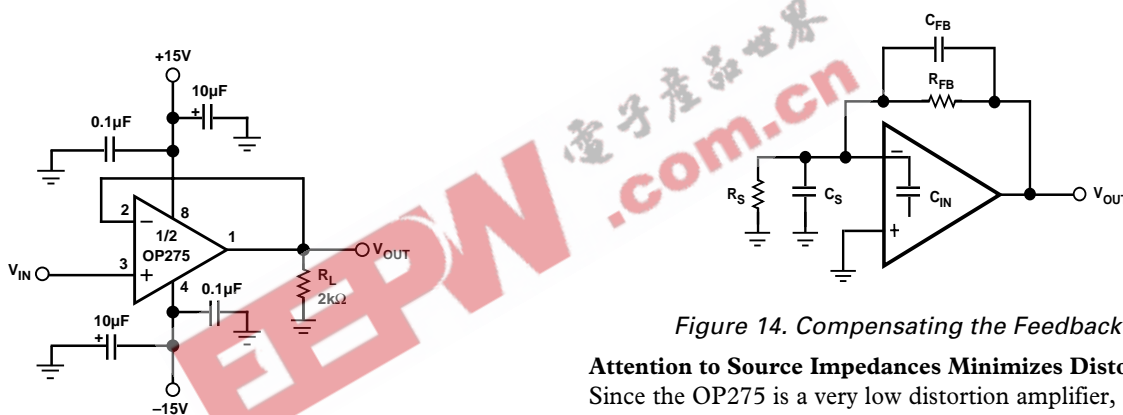

Figure 12. Unity Gain Follower

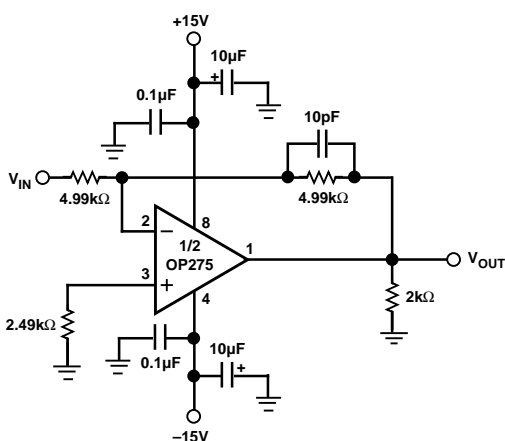

Figure 13. Unity Gain Inverter

In inverting and noninverting applications, the feedback resistance forms a pole with the source resistance and capacitance ( $R_S$  and  $C_S$ ) and the OP275's input capacitance ( $C_{IN}$ ), as shown in Figure 14. With  $R_S$  and  $R_F$  in the kilohm range, this pole can create excess phase shift and even oscillation. A small capacitor,  $C_{FB}$ , in parallel and  $R_{FB}$  eliminates this problem. By setting  $R_S (C_S + C_{IN}) = R_{FB} C_{FB}$ , the effect of the feedback pole is completely removed.

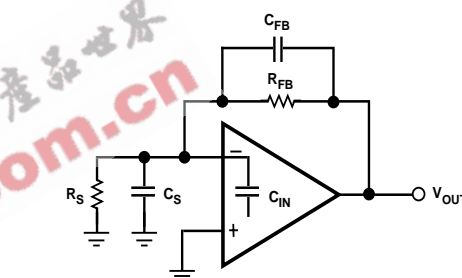

Figure 14. Compensating the Feedback Pole

**Attention to Source Impedances Minimizes Distortion**

Since the OP275 is a very low distortion amplifier, careful attention should be given to source impedances seen by both inputs. As with many FET-type amplifiers, the p-channel JFETs in the OP275's input stage exhibit a gate-to-source capacitance that varies with the applied input voltage. In an inverting configuration, the inverting input is held at a virtual ground and, as such, does not vary with input voltage. Thus, since the gate-to-source voltage is constant, there is no distortion due to input capacitance modulation. In noninverting applications, however, the gate-to-source voltage is not constant. The resulting capacitance modulation can cause distortion above 1 kHz if the input impedance is  $> 2 \text{ k}\Omega$  and unbalanced.

Figure 15 shows some guidelines for maximizing the distortion performance of the OP275 in noninverting applications. The best way to prevent unwanted distortion is to ensure that the parallel combination of the feedback and gain setting resistors ( $R_F$  and  $R_G$ ) is less than  $2 \text{ k}\Omega$ . Keeping the values of these resistors small has the added benefits of reducing the thermal noise

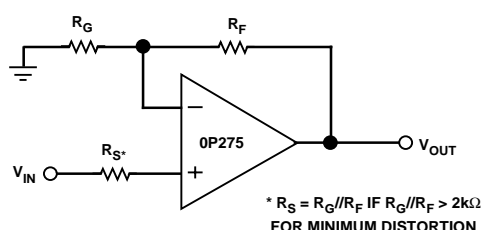

Figure 15. Balanced Input Impedance to Minimize Distortion in Noninverting Amplifier Circuits

# OP275

of the circuit and dc offset errors. If the parallel combination of  $R_F$  and  $R_G$  is larger than  $2\text{ k}\Omega$ , then an additional resistor,  $R_S$ , should be used in series with the noninverting input. The value of  $R_S$  is determined by the parallel combination of  $R_F$  and  $R_G$  to maintain the low distortion performance of the OP275.

## Driving Capacitive Loads

The OP275 was designed to drive both resistive loads to  $600\ \Omega$  and capacitive loads of over  $1000\text{ pF}$  and maintain stability. While there is a degradation in bandwidth when driving capacitive loads, the designer need not worry about device stability. The graph in Figure 16 shows the 0 dB bandwidth of the OP275 with capacitive loads from  $10\text{ pF}$  to  $1000\text{ pF}$ .

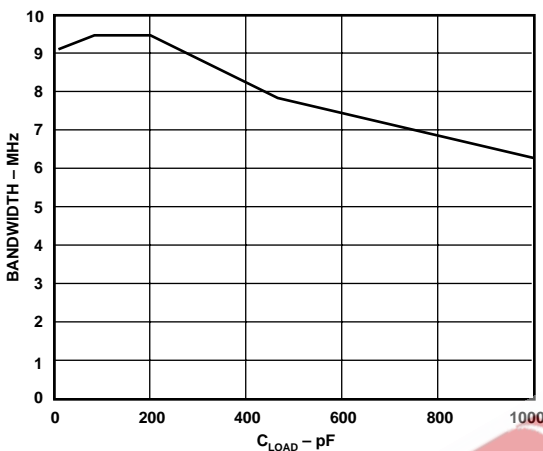

Figure 16. Bandwidth vs.  $C_{LOAD}$

## High Speed, Low Noise Differential Line Driver

The circuit of Figure 17 is a unique line driver widely used in industrial applications. With  $\pm 18\text{ V}$  supplies, the line driver can deliver a differential signal of  $30\text{ V p-p}$  into a  $2.5\text{ k}\Omega$  load. The high slew rate and wide bandwidth of the OP275 combine to yield a full power bandwidth of  $130\text{ kHz}$  while the low noise front end produces a referred-to-input noise voltage spectral density of  $10\text{ nV}/\sqrt{\text{Hz}}$ .

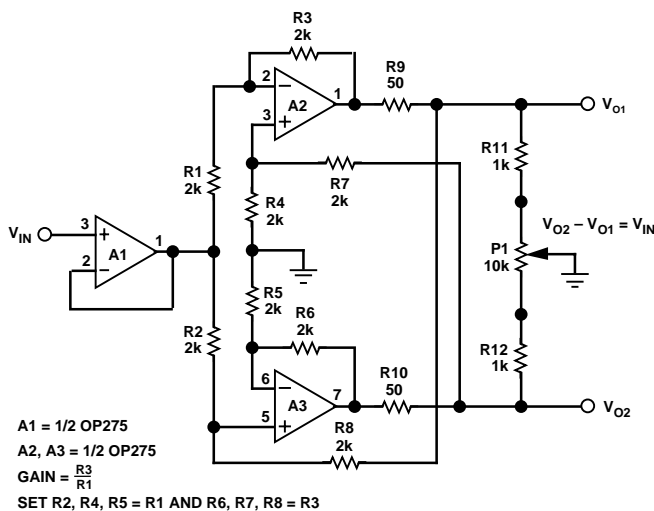

Figure 17. High Speed, Low Noise Differential Line Driver

The design is a transformerless, balanced transmission system where output common-mode rejection of noise is of paramount

importance. Like the transformer based design, either output can be shorted to ground for unbalanced line driver applications without changing the circuit gain of 1. Other circuit gains can be set according to the equation in the diagram. This allows the design to be easily set to noninverting, inverting, or differential operation.

## A 3-Pole, 40 kHz Low-Pass Filter

The closely matched and uniform ac characteristics of the OP275 make it ideal for use in GIC (Generalized Impedance Converter) and FDNR (Frequency-Dependent Negative Resistor) filter applications. The circuit in Figure 18 illustrates a linear-phase, 3-pole,  $40\text{ kHz}$  low-pass filter using an OP275 as an inductance simulator (gyrator). The circuit uses one OP275 (A2 and A3) for the FDNR and one OP275 (A1 and A4) as an input buffer and bias current source for A3. Amplifier A4 is configured in a gain of 2 to set the pass band magnitude response to 0 dB. The benefits of this filter topology over classical approaches are that the op amp used in the FDNR is not in the signal path and that the filter's performance is relatively insensitive to component variations. Also, the configuration is such that large signal levels can be handled without overloading any of the filter's internal nodes. As shown in Figure 19, the OP275's symmetric slew rate and low distortion produce a clean, well-behaved transient response.

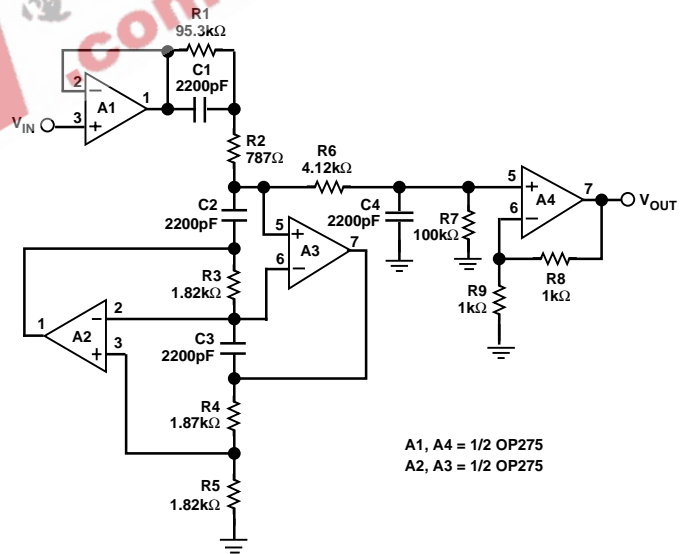
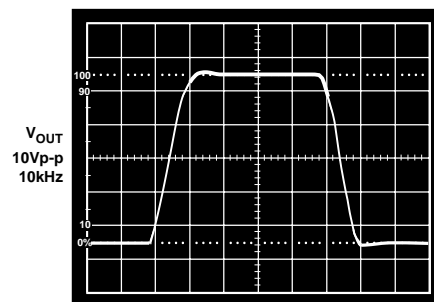

Figure 18. A 3-Pole, 40 kHz Low-Pass Filter



SCALE: VERTICAL-2V/ DIV  
HORIZONTAL-10µs/ DIV

Figure 19. Low-Pass Filter Transient Response

OP275 SPICE Model

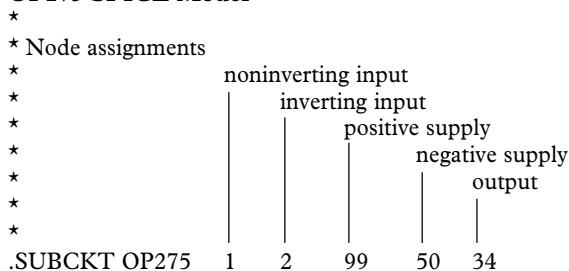

```

.SUBCKT OP275 1 2 99 50 34
*
* INPUT STAGE & POLE AT 100 MHz
*
R3 5 51 2.188
R4 6 51 2.188
CIN 1 2 3.7E-12
CM1 1 98 7.5E-12
CM2 2 98 7.5E-12
C2 5 6 364E-12
I1 97 4 100E-3
IOS 1 2 1E-9
EOS 9 3 POLY(1) 26 28 0.5E-3 1
Q1 5 2 7 QX
Q2 6 9 8 QX
R5 7 4 1.672
R6 8 4 1.672
D1 2 36 DZ
D2 1 36 DZ
EN 3 1 10 0 1
GN1 0 2 13 0 1E-3
GN2 0 1 16 0 1E-3
*
EREF 98 0 28 0 1
EP 97 0 99 0 1
EM 51 0 50 0 1

```

```

* VOLTAGE NOISE SOURCE
*
DN1 35 10 DEN
DN2 10 11 DEN
VN1 35 0 DC 2
VN2 0 11 DC 2

```

```

* CURRENT NOISE SOURCE
*
DN3 12 13 DIN
DN4 13 14 DIN
VN3 12 0 DC 2
VN4 0 14 DC 2

```

```

* CURRENT NOISE SOURCE
*
DN5 15 16 DIN
DN6 16 17 DIN
VN5 15 0 DC 2
VN6 0 17 DC 2

```

```

* GAIN STAGE & DOMINANT POLE AT 32 Hz
*
R7 18 98 1.09E6
C3 18 98 4.55E-9
G1 98 18 5 6 4.57E-1
V2 97 19 1.35
V3 20 51 1.35
D3 18 19 DX
D4 20 18 DX

```

```

* POLE/ZERO PAIR AT 1.5 MHz/2.7 MHz
*
R8 21 98 1E-3
R9 21 22 1.25E-3
C4 22 98 47.2E-12
G2 98 21 18 28 1E-3
*
* POLE AT 100 MHz
*
R10 23 98 1
C5 23 98 1.59E-9
G3 98 23 21 28 1
*
* POLE AT 100 MHz
*
R11 24 98 1
C6 24 98 1.59E-9
G4 98 24 23 28 1
*
* COMMON-MODE GAIN NETWORK WITH ZERO AT 1 kHz
*
R12 25 26 1E6
C7 25 26 1.5915E-12
R13 26 98 1
E2 25 98 POLY(2) 1 98 2 98 0 2.50 2.50
*
* POLE AT 100 MHz
*
R14 27 98 1
C8 27 98 1.59E-9
G5 98 27 24 28 1
*
* OUTPUT STAGE
*
R15 28 99 100E3
R16 28 50 100E3
C9 28 50 1E-6
ISY 99 50 1.85E-3
R17 29 99 100
R18 29 50 100
L2 29 34 1E-9
G6 32 50 27 29 10E-3
G7 33 50 29 27 10E-3
G8 29 99 99 27 10E-3
G9 50 29 27 50 10E-3
V4 30 29 1.3
V5 29 31 3.8
F1 29 0 V4 1
F2 0 29 V5 1
D5 27 30 DX
D6 31 27 DX
D7 99 32 DX
D8 99 33 DX
D9 50 32 DY
D10 50 33 DY
*
* MODELS USED
*
.MODEL QX PNP(BF=5E5)
.MODEL DX D(IS=1E-12)
.MODEL DY D(IS=1E-15 BV=50)
.MODEL DZ D(IS=1E-15 BV=7.0)
.MODEL DEN D(IS=1E-12 RS=4.35K KF=1.95E-15 AF=1)
.MODEL DIN D(IS=1E-12 RS=268 KF=1.08E-15 AF=1)
.ENDS

```

# OP275

## OUTLINE DIMENSIONS

Dimensions shown in inches and (mm).

### 8-Lead Narrow-Body SOIC (S Suffix)

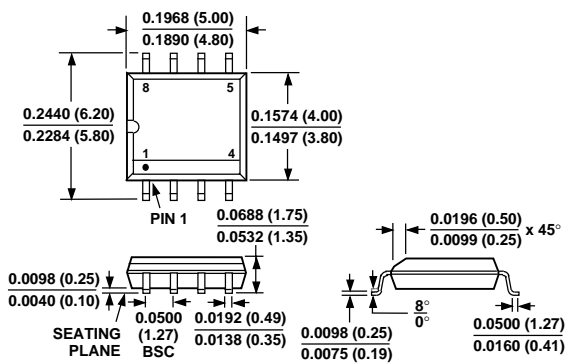

### 8-Lead Epoxy DIP (P Suffix)

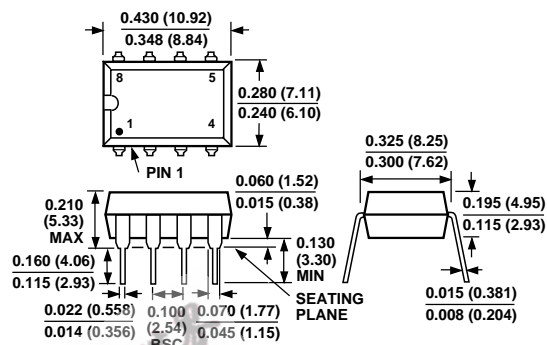

EEPW.com.cn 电子產品