

GaAs Plastic Infrared Emitting Diodes Types OP145A, OP145B, OP145C, OP145D

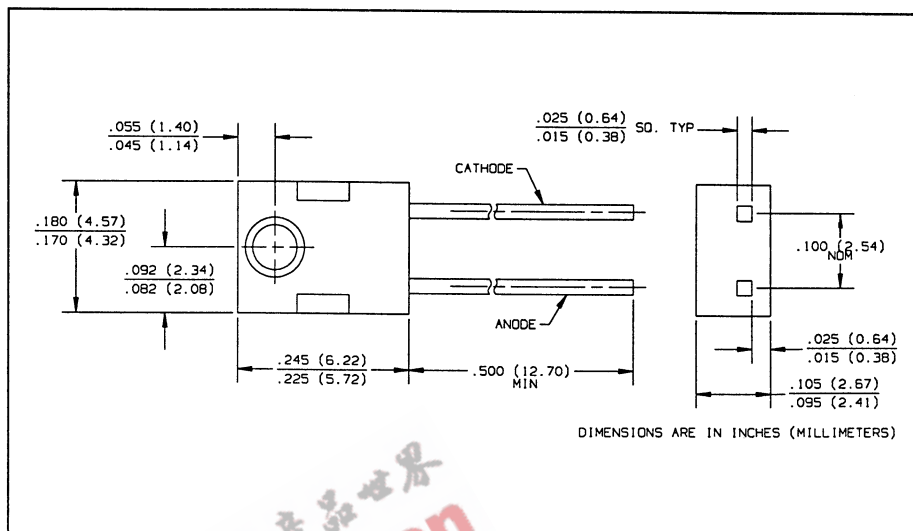
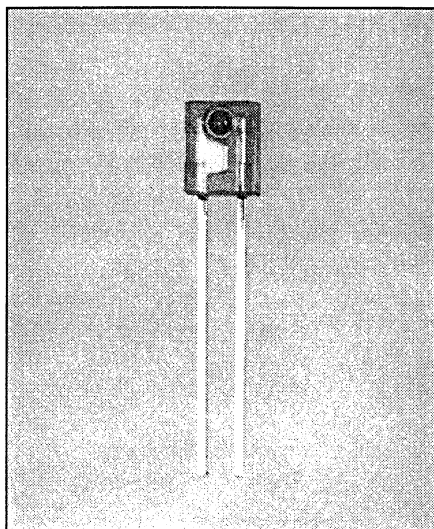

Features

- Wide irradiance pattern
- Mechanically and spectrally matched to the OP555 and OP565 series devices
- Variety of power ranges

Description

The OP145 series devices are 935nm high intensity gallium arsenide infrared emitting diodes molded in IR transmissive amber tinted epoxy packages. The side-looking packages are for use in PC board slotted switches or as an easy mounted PC board interrupter.

Replaces

K6550 series

Absolute Maximum Ratings ($T_A = 25^\circ\text{C}$ unless otherwise noted)

Reverse Voltage	2.0 V
Continuous Forward Current	50 mA
Peak Forward Current (1 μs pulse width, 300 pps)	3.0 A
Storage and Operating Temperature Range	-40°C to $+100^\circ\text{C}$
Lead Soldering Temperature [1/16 inch (1.6mm) from case for 5 sec. with soldering iron]	$260^\circ\text{C}^{(1)}$
Power Dissipation	$100\text{ mW}^{(2)}$

Notes:

- (1) RMA flux is recommended. Duration can be extended to 10 sec. max. when flow soldering. A max. of 20 grams force may be applied to the leads when soldering.
- (2) Derate linearly $1.33\text{ mW}/^\circ\text{C}$ above 25°C .
- (3) $E_{e(\text{APT})}$ is a measurement of the average apertured radiant incidence upon a sensing area $0.180"$ (4.57 mm) in diameter, perpendicular to and centered on the mechanical axis of the lens, and $0.653"$ (16.6 mm) from the lens tip. $E_{e(\text{APT})}$ is not necessarily uniform within the measured area.

Typical Performance Curves

Percent Changes in Radiant Intensity vs Time

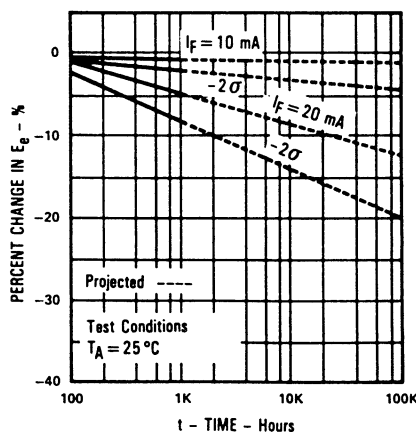

Coupling Characteristics of OP145 and OP555

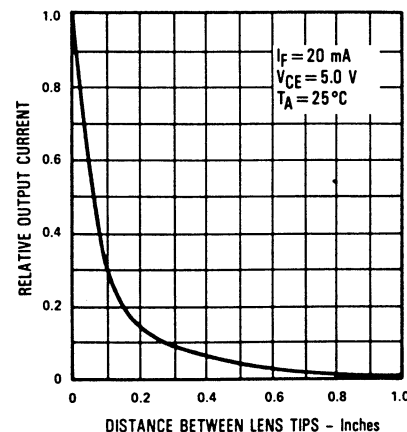

Types OP145A, OP145B, OP145C, OP145D

Electrical Characteristics ($T_A = 25^\circ\text{C}$ unless otherwise noted)

SYMBOL	PARAMETER	MIN	TYP	MAX	UNITS	TEST CONDITIONS
$E_e(\text{APT})$	Apertured Radiant Incidence	OP145D 0.10		0.40	mW/cm^2	$I_F = 20 \text{ mA}^{(3)}$
		OP145C 0.20		0.55	mW/cm^2	$I_F = 20 \text{ mA}^{(3)}$
		OP145B 0.30			mW/cm^2	$I_F = 20 \text{ mA}^{(3)}$
		OP145A 0.40			mW/cm^2	$I_F = 20 \text{ mA}^{(3)}$
V_F	Forward Voltage			1.60	V	$I_F = 20 \text{ mA}$
I_R	Reverse Current			100	μA	$V_R = 2.0 \text{ V}$
λ_p	Wavelength at Peak Emission		935		nm	$I_F = 10 \text{ mA}$
B	Spectral Bandwidth Between Half Power Points		50		nm	$I_F = 10 \text{ mA}$
$\Delta\lambda_p/\Delta T$	Spectral Shift with Temperature		+0.30		$\text{nm}/^\circ\text{C}$	$I_F = \text{Constant}$
θ_{HP}	Emission Angle at Half Power Points		40		Deg.	$I_F = 20 \text{ mA}$
t_r	Output Rise Time		1000		ns	$I_{F(\text{PK})} = 100 \text{ mA}$, $\text{PW} = 10 \mu\text{s}$, D.C. = 10.0%
t_f	Output Fall Time		500		ns	

INFRARED EMITTING

Typical Performance Curves

Forward Voltage vs Forward Current

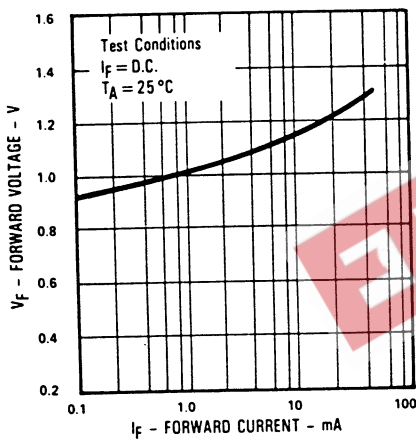

Forward Voltage and Radiant Incidence vs Forward Current

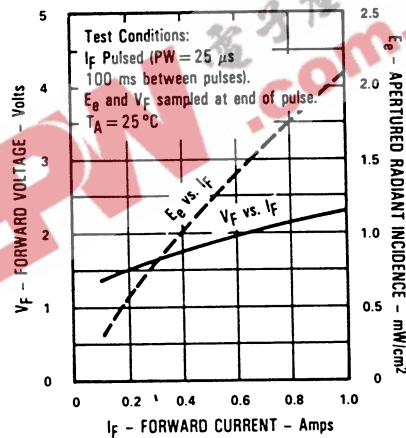

Forward Voltage vs Ambient Temperature

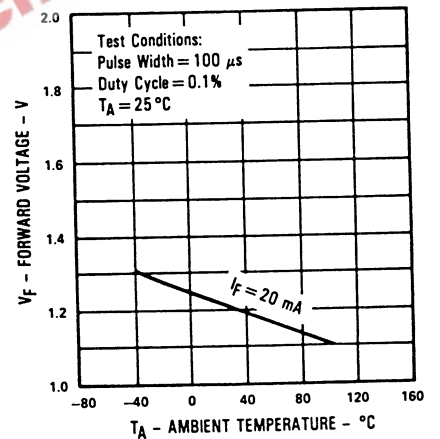

Rise Time and Fall Time vs Forward Current

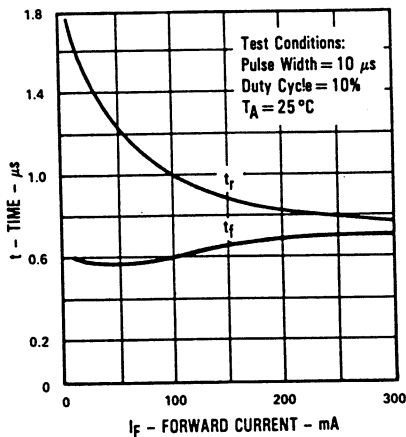

Relative Radiant Intensity vs Ambient Temperature

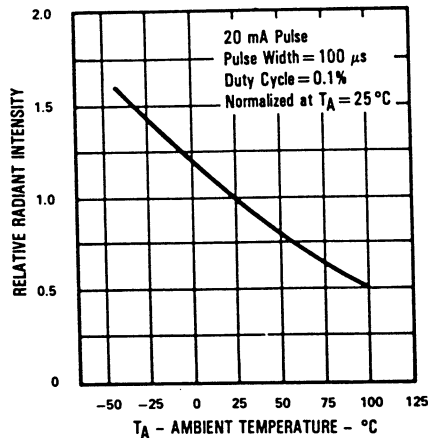

Relative Radiant Intensity vs Angular Displacement

