

### FEATURES

- Excellent  $TCV_{OS}$  Match .....  $2\mu V/^{\circ}C$  Max
- Low Input Offset Voltage .....  $150\mu V$  Max
- Low Supply Current .....  $100\mu A$
- Single-Supply Operation .....  $+5V$  to  $+30V$
- Low Input Offset Voltage Drift .....  $0.75\mu V/^{\circ}C$
- High Open-Loop Gain .....  $2000V/mV$
- High PSRR .....  $3\mu V/V$
- Low Input Bias Current .....  $12nA$
- Wide Common-Mode Voltage Range .....  $V-$  to within  $1.5V$  of  $V+$
- Pin Compatible with 1458, LM158, LM2904
- Available in Die Form

### GENERAL DESCRIPTION

The OP-220 is a monolithic dual operational amplifier that can be used either in single or dual supply operation. The low offset voltage, and input offset voltage tracking as low as  $1.0\mu V/^{\circ}C$ , make this the first micropower precision dual operational amplifier.

The excellent specifications of the individual amplifiers combined with the tight matching and temperature tracking between channels provides high performance in instrumentation amplifier designs. The individual amplifiers feature extremely low input offset voltage, low offset voltage drift, low noise voltage, and low bias current. They are fully compensated and protected.

Matching between channels is provided on all critical parameters including input offset voltage, tracking of offset voltage vs. temperature, non-inverting bias currents, and common-mode rejection ratios.

### ORDERING INFORMATION †

$T_A = +25^{\circ}C$ $V_{OS}$ MAX ( $\mu V$ )	PACKAGE			OPERATING TEMPERATURE RANGE
	TO-99	CERDIP 8-PIN	PLASTIC 8-PIN	
150	OP220AJ*	OP220AZ	—	MIL
150	—	OP220EZ	—	IND
300	—	OP220FZ	—	IND
750	OP220CJ*	OP220CZ	—	MIL
750	OP220GJ	OP220GZ	OP220GP	XIND
750	—	—	OP220GS	XIND

\* For devices processed in total compliance to MIL-STD-883, add /883 after part number. Consult factory for 883 data sheet.

† Burn-in is available on commercial and industrial temperature range parts in CerDIP, plastic DIP, and TO-can packages.

### PIN CONNECTIONS

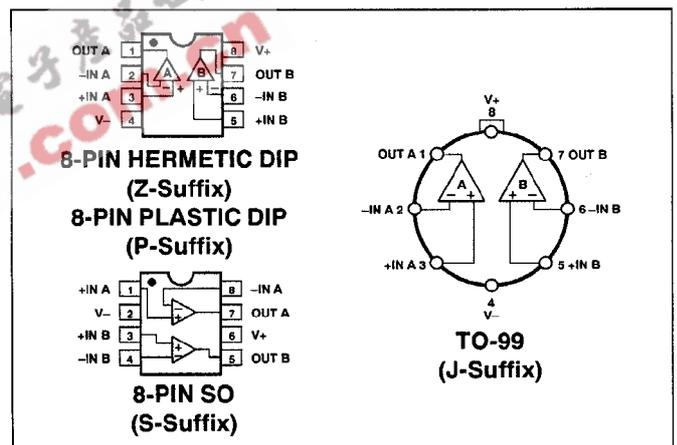

### SIMPLIFIED SCHEMATIC (Each Amplifier)

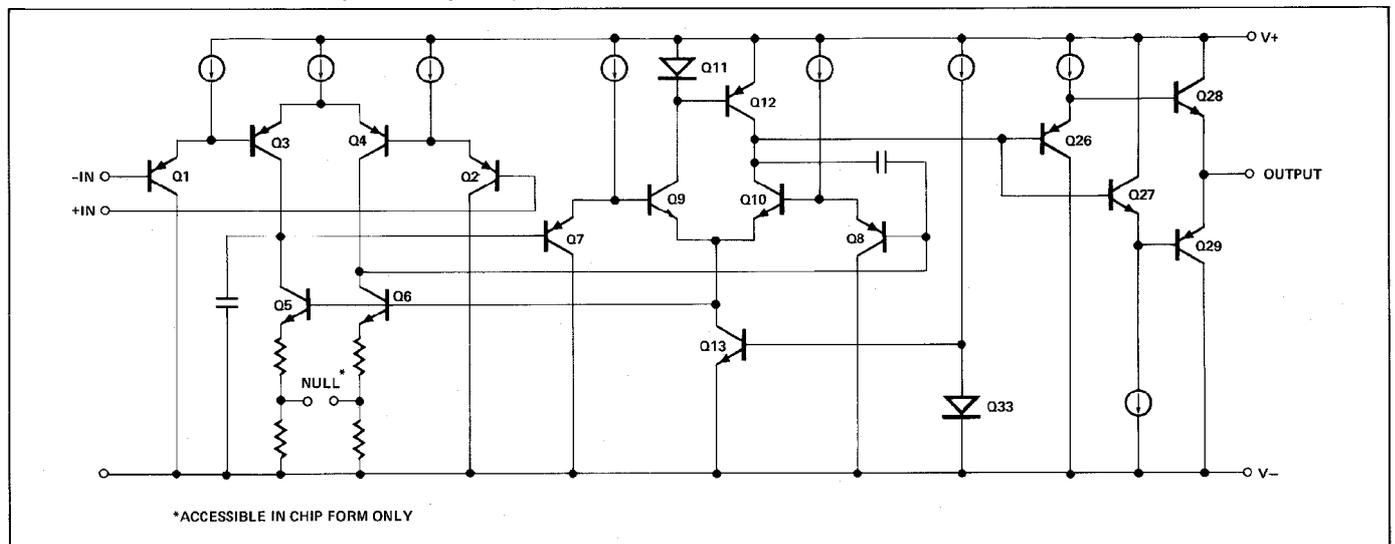

\*ACCESSIBLE IN CHIP FORM ONLY

# OP-220

## ABSOLUTE MAXIMUM RATINGS (Note 1)

Supply Voltage .....	±18V
Differential Input Voltage .....	30V or Supply Voltage
Input Voltage .....	Supply Voltage
Output Short-Circuit Duration .....	Indefinite
Storage Temperature Range .....	-65°C to +150°C
Operating Temperature Range	
OP-220A, C .....	-55°C to +125°C
OP-220E, F .....	-25°C to +85°C
OP-220G .....	-40°C to +85°C
Lead Temperature (Soldering, 60 sec) .....	+300°C
Junction Temperature (T <sub>J</sub> ) .....	-65°C to +150°C

PACKAGE TYPE	Θ <sub>JA</sub> (Note 2)	Θ <sub>JC</sub>	UNITS
TO-99 (J)	150	18	°C/W
8-Pin Hermetic DIP (Z)	148	18	°C/W
8-Pin Plastic DIP (P)	103	43	°C/W
8-Pin SO (S)	158	43	°C/W

### NOTES:

1. Absolute maximum ratings apply to both DICE and packaged parts, unless otherwise noted.
2. Θ<sub>JA</sub> is specified for worst case mounting conditions, i.e., Θ<sub>JA</sub> is specified for device in socket for CerDIP and P-DIP packages; Θ<sub>JA</sub> is specified for device soldered to printed circuit board for SO package.

## ELECTRICAL CHARACTERISTICS at V<sub>S</sub> = ±2.5V to ±15V, T<sub>A</sub> = +25°C, unless otherwise noted.

PARAMETER	SYMBOL	CONDITIONS	OP-220A/E			OP-220F			OP-220C/G			UNITS
			MIN	TYP	MAX	MIN	TYP	MAX	MIN	TYP	MAX	
Input Offset Voltage	V <sub>OS</sub>	V <sub>S</sub> = ±2.5V to ±15V	—	120	150	—	250	300	—	500	750	μV
Input Offset Current	I <sub>OS</sub>	V <sub>CM</sub> = 0	—	0.15	1.5	—	0.2	2	—	0.2	3.5	nA
Input Bias Current	I <sub>B</sub>	V <sub>CM</sub> = 0	—	12	20	—	13	25	—	14	30	nA
Input Voltage Range	IVR	V <sub>+</sub> = 5V, V <sub>-</sub> = 0V, V <sub>S</sub> = ±15V	0/3.5 -15/13.5	—	—	0/3.5 -15/13.5	—	—	0/3.5 -15/13.5	—	—	V
Common-Mode Rejection Ratio	CMRR	V <sub>+</sub> = 5V, V <sub>-</sub> = 0V, 0V ≤ V <sub>CM</sub> ≤ 3.5V	90	100	—	85	90	—	75	85	—	dB
		V <sub>S</sub> = ±15V, -15V ≤ V <sub>CM</sub> ≤ 13.5V	95	100	—	90	95	—	80	90	—	
Power Supply Rejection Ratio	PSRR	V <sub>S</sub> = ±2.5V to ±15V	—	3	10	—	10	32	—	32	100	μV/V
		V <sub>-</sub> = 0V, V <sub>+</sub> = 5V to 30V	—	6	18	—	18	57	—	57	180	
Large-Signal Voltage Gain	A <sub>VO</sub>	V <sub>+</sub> = 5V, V <sub>-</sub> = 0V, R <sub>L</sub> = 100kΩ 1V ≤ V <sub>O</sub> ≤ 3.5V	500	1000	—	500	800	—	300	500	—	V/mV
		V <sub>S</sub> = ±15V, R <sub>L</sub> = 25kΩ	1000	2000	—	1000	2000	—	800	1600	—	
		V <sub>O</sub> = ±10V	—	—	—	—	—	—	—	—	—	
Output Voltage Swing	V <sub>O</sub>	V <sub>+</sub> = 5V, V <sub>-</sub> = 0V, R <sub>L</sub> = 10kΩ	0.7/4	—	—	0.7/4	—	—	0.8/4	—	—	V
		V <sub>S</sub> = ±15V, R <sub>L</sub> = 25kΩ	±14	—	—	±14	—	—	±14	—	—	
Slew Rate	SR	R <sub>L</sub> = 25kΩ, (Note 1)	—	0.05	—	—	0.05	—	—	0.05	—	V/μs
Bandwidth	BW	A <sub>VCL</sub> = +1, R <sub>L</sub> = 25kΩ	—	200	—	—	200	—	—	200	—	kHz
Supply Current (Both Amplifiers)	I <sub>SY</sub>	V <sub>S</sub> = ±2.5V, No Load	—	100	115	—	115	125	—	125	135	μA
		V <sub>S</sub> = ±15V, No Load	—	140	170	—	150	190	—	205	220	

## ELECTRICAL CHARACTERISTICS at V<sub>S</sub> = ±2.5V to ±15V, -55°C ≤ T<sub>A</sub> ≤ +125°C for OP-220A and C, -25°C ≤ T<sub>A</sub> ≤ +85°C for OP-220E and F, -40°C ≤ T<sub>A</sub> ≤ +85°C for OP-220G, unless otherwise noted.

PARAMETER	SYMBOL	CONDITIONS	OP-220A/E			OP-220F			OP-220C/G			UNITS
			MIN	TYP	MAX	MIN	TYP	MAX	MIN	TYP	MAX	
Average Input Offset Voltage Drift (Note 1)	TCV <sub>OS</sub>	V <sub>S</sub> = ±15V	—	0.75	1.5	—	1.2	2	—	2	3	μV/°C
Input Offset Voltage	V <sub>OS</sub>		—	200	300	—	400	500	—	1000	1300	μV
Input Offset Current	I <sub>OS</sub>	V <sub>CM</sub> = 0	—	0.5	2	—	0.6	2.5	—	0.8	5	nA
Input Bias Current	I <sub>B</sub>	V <sub>CM</sub> = 0	—	12	25	—	13	30	—	14	40	nA
Input Voltage Range	IVR	V <sub>+</sub> = 5V, V <sub>-</sub> = 0V, V <sub>S</sub> = ±15V	0/3.2 -15/13.2	—	—	0/3.2 -15/13.2	—	—	0/3.2 -15/13.2	—	—	V
Common-Mode Rejection Ratio	CMRR	V <sub>+</sub> = 5V, V <sub>-</sub> = 0V, 0V ≤ V <sub>CM</sub> ≤ 3.2V	85	90	—	80	85	—	70	80	—	dB
		V <sub>S</sub> = ±15V	90	95	—	85	90	—	75	85	—	
		-15V ≤ V <sub>CM</sub> ≤ 13.2V	—	—	—	—	—	—	—	—	—	
Power Supply Rejection Ratio	PSRR	V <sub>S</sub> = ±2.5V to ±15V	—	6	18	—	18	57	—	57	180	μV/V
		V <sub>-</sub> = 0V, V <sub>+</sub> = 5V to 30V	—	10	32	—	32	100	—	100	320	

# OP-220

**ELECTRICAL CHARACTERISTICS** at  $V_S = \pm 2.5V$  to  $\pm 15V$ ,  $-55^\circ C \leq T_A \leq +125^\circ C$  for OP-220A and C,  $-25^\circ C \leq T_A \leq +85^\circ C$  for OP-220E and F,  $-40^\circ C \leq T_A \leq +85^\circ C$  for OP-220G, unless otherwise noted. *Continued*

PARAMETER	SYMBOL	CONDITIONS	OP-220A/E			OP-220F			OP-220C/G			UNITS
			MIN	TYP	MAX	MIN	TYP	MAX	MIN	TYP	MAX	
Large-Signal Voltage Gain	$A_{VO}$	$V_S = \pm 15V$ , $R_L = 50k\Omega$ $V_O = \pm 10V$	500	1000	—	500	800	—	400	500	—	V/mV
Output Voltage Swing	$V_O$	$V_+ = 5V$ , $V_- = 0V$ , $R_L = 20k\Omega$	0.9/3.8	—	—	0.9/3.8	—	—	1/3.8	—	—	V
		$V_S = \pm 15V$ , $R_L = 50k\Omega$	$\pm 13.8$	—	—	$\pm 13.8$	—	—	$\pm 13.8$	—	—	
Supply Current (Both Amplifiers)	$I_{SY}$	$V_S = \pm 2.5V$ , No Load	—	135	170	—	155	185	—	170	210	$\mu A$
		$V_S = \pm 15V$ , No Load	—	190	250	—	200	280	—	275	330	

NOTE: 1. Sample tested.

**MATCHING CHARACTERISTICS** at  $V_S = \pm 15V$ ,  $T_A = 25^\circ C$ , unless otherwise noted.

PARAMETER	SYMBOL	CONDITIONS	OP-220A/E			OP-220F			OP-220C/G			UNITS
			MIN	TYP	MAX	MIN	TYP	MAX	MIN	TYP	MAX	
Input Offset Voltage Match	$\Delta V_{OS}$		—	150	300	—	250	500	—	300	600	$\mu V$
Average Noninverting Bias Current	$I_{B^+}$	$V_{CM} = 0$	—	10	20	—	15	25	—	20	30	nA
Noninverting Offset Current	$I_{OS^+}$	$V_{CM} = 0$	—	0.7	1.5	—	1	2	—	1.4	2.5	nA
Common-Mode Rejection Ratio Match (Note 1)	$\Delta CMRR$	$V_{CM} = -15V$ to $+13.5V$	92	100	—	87	95	—	72	85	—	dB
Power Supply Rejection Ratio Match (Note 2)	$\Delta PSRR$	$V_S = \pm 2.5V$ to $\pm 15V$	—	6	14	—	18	44	—	57	140	$\mu V/V$

**MATCHING CHARACTERISTICS** at  $V_S = \pm 15V$ ,  $-55^\circ C \leq T_A \leq +125^\circ C$  for OP-220A and C;  $-25^\circ C \leq T_A \leq +85^\circ C$  for OP-220E and F;  $-40^\circ C \leq T_A \leq +85^\circ C$  for OP-220G, unless otherwise noted. Grades E, F are sample tested.

PARAMETER	SYMBOL	CONDITIONS	OP-220A/E			OP-220F			OP-220C/G			UNITS
			MIN	TYP	MAX	MIN	TYP	MAX	MIN	TYP	MAX	
Input Offset Voltage Match	$\Delta V_{OS}$		—	250	500	—	400	800	—	800	1800	$\mu V$
Input Offset Voltage Tracking	$TC\Delta V_{OS}$	(Note 3)	—	1	2	—	1.5	3	—	1.5	5	$\mu V/^\circ C$
Average Noninverting Bias Current	$I_{B^+}$	$V_{CM} = 0$	—	10	25	—	15	30	—	22	40	nA
Average Drift of Noninverting Bias Current	$TCI_{B^+}$	$V_{CM} = 0$ (Note 3)	—	15	25	—	15	30	—	30	50	$pA/^\circ C$
Noninverting Offset Current	$I_{OS^+}$	$V_{CM} = 0$	—	0.7	2	—	1	2.5	—	2.5	5	nA
Average Drift of Noninverting Offset Current	$TCI_{OS^+}$	$V_{CM} = 0$ (Note 3)	—	7	15	—	12	22.5	—	15	30	$pA/^\circ C$
Common-Mode Rejection Ratio Match (Note 1)	$\Delta CMRR$	$V_{CM} = -15V$ to $+13V$	87	98	—	82	96	—	72	80	—	dB
Power Supply Rejection Ratio Match (Note 2)	$\Delta PSRR$	$V_S = \pm 2.5V$ to $\pm 15V$	—	10	26	—	30	78	—	57	250	$\mu V/V$

**NOTES:**

- $\Delta CMRR$  is  $20 \log_{10} V_{CM}/\Delta CME$ , where  $V_{CM}$  is the voltage applied to both noninverting inputs and  $\Delta CME$  is the difference in common-mode input-referred error.
- $\Delta PSRR$  is: 
$$\frac{\text{Input-referred differential error}}{\Delta V_S}$$
- Sample tested.

# OP-220

## DICE CHARACTERISTICS

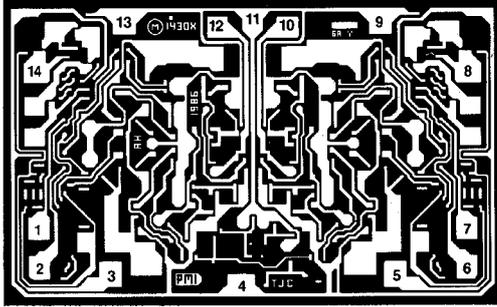

DIE SIZE 0.097 × 0.063 inch, 6111 sq. mils  
(2.464 × 1.600 mm, 3.94 sq. mm)

NOTE: All V+ PADS ARE INTERNALLY CONNECTED.

1. INVERTING INPUT (A)
2. NONINVERTING INPUT (A)
3. BALANCE (A)
4. V-
5. BALANCE (B)
6. NONINVERTING INPUT (B)
7. INVERTING INPUT (B)
8. BALANCE (B)
9. V+
10. OUT (B)
11. V+
12. OUT (A)
13. V+
14. BALANCE (A)

**WAFER TEST LIMITS** at  $V_S = \pm 2.5V$  to  $\pm 15V$ ,  $T_A = 25^\circ C$  for OP-220N, OP-220G and OP-220GR devices;  $T_A = 125^\circ C$  for OP-221NT devices, unless otherwise noted.

PARAMETER	SYMBOL	CONDITIONS	OP-220NT LIMIT	OP-220N LIMIT	OP-220G LIMIT	OP-220GR LIMIT	UNITS
Input Offset Voltage	$V_{OS}$		350	200	500	1000	$\mu V$ MAX
Input Offset Voltage Match	$\Delta V_{OS}$		500	300	500	600	$\mu V$ MAX
Input Offset Current	$I_{OS}$	$V_{CM} = 0$	2.5	2	3.5	5	nA MAX
Input Bias Current	$I_B$	$V_{CM} = 0$	30	25	30	40	nA MAX
Input Voltage Range	IVR	$V_S = \pm 15V$	-15/13.5	-15/13.5	-15/13.5	-15/13.5	V MIN
Common-Mode Rejection Ratio	CMRR	$V_- = 0V, V_+ = 5V, 0V \leq V_{CM} \leq 3.5V$	83	88	83	75	dB MIN
		$-15V \leq V_{CM} \leq 13.5V, V_S = \pm 15V$	88	93	88	80	
Power Supply Rejection Ratio	PSRR	$V_S = \pm 2.5V$ to $\pm 15V$	22	12.5	40	100	$\mu V/V$ MAX
		$V_- = 0V, V_+ = 5V$ to 30V	36	22.5	70	180	
Large-Signal Voltage Gain	$A_{VO}$	$R_L = 25k\Omega, V_S = \pm 15V$ $V_O = \pm 10V$	—	1000	800	500	V/mV MIN
		$V_S = \pm 15V, R_L = 50k\Omega$ $V_O = \pm 10V$	500	—	—	—	
Output Voltage Swing	$V_O$	$V_+ = 5V, V_- = 0V, R_L = 10k\Omega$ $V_S = \pm 15V, R_L = 25k\Omega$	—	0.7/4	0.8/4	0.8/3.8	V MIN
		$V_+ = 5V, V_- = 0V,$ $R_L = 20k\Omega$	0.9/3.8	—	—	—	
		$V_S = \pm 15V, R_L = 50k\Omega$	$\pm 13.8$	—	—	—	
Supply Current (Both Amplifiers)	$I_{SY}$	$V_S = \pm 2.5V$ , No Load	170	125	135	170	$\mu A$ MAX
		$V_S = \pm 15V$ , No Load	250	190	220	300	

**NOTE:**

Electrical tests are performed at wafer probe to the limits shown. Due to variations in assembly methods and normal yield loss, yield after packaging is not guaranteed for standard product dice. Consult factory to negotiate specifications based on dice lot qualification through sample lot assembly and testing.

**TYPICAL ELECTRICAL CHARACTERISTICS** at  $V_S = \pm 15V$ ,  $T_A = +25^\circ C$ , unless otherwise noted.

PARAMETER	SYMBOL	CONDITIONS	OP-220NT TYPICAL	OP-220N TYPICAL	OP-220G TYPICAL	OP-220GR TYPICAL	UNITS
Average Input Offset Voltage Drift	$TCV_{OS}$		1.5	1.5	2	3	$\mu V/^\circ C$
Large-Signal Voltage Gain	$A_{VO}$	$R_L = 25k\Omega$	2000	2000	1600	800	V/mV

TYPICAL PERFORMANCE CHARACTERISTICS

**NORMALIZED OFFSET VOLTAGE vs TEMPERATURE**

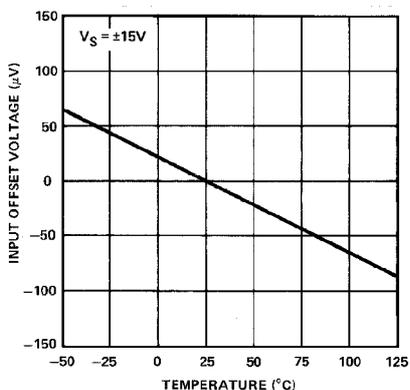

**INPUT OFFSET VOLTAGE vs POWER SUPPLY VOLTAGE**

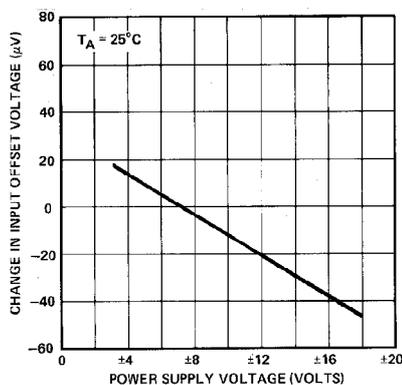

**OPEN-LOOP GAIN vs TEMPERATURE**

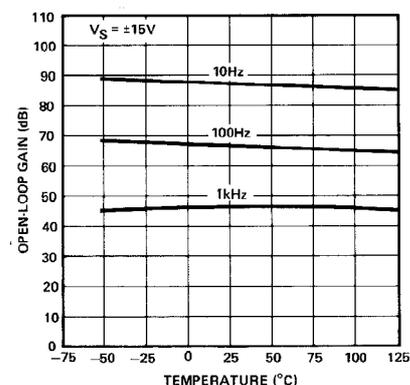

**INPUT BIAS CURRENT vs TEMPERATURE**

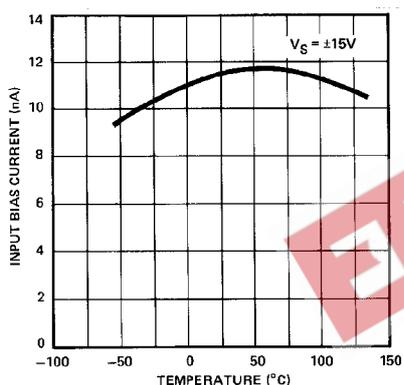

**INPUT OFFSET CURRENT vs TEMPERATURE**

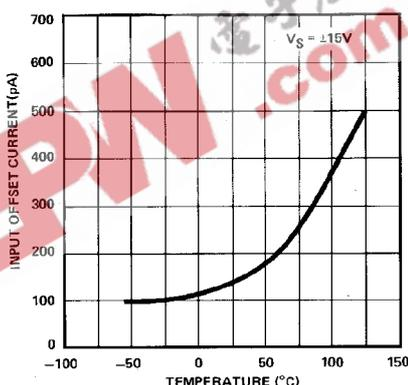

**SUPPLY CURRENT vs SUPPLY VOLTAGE**

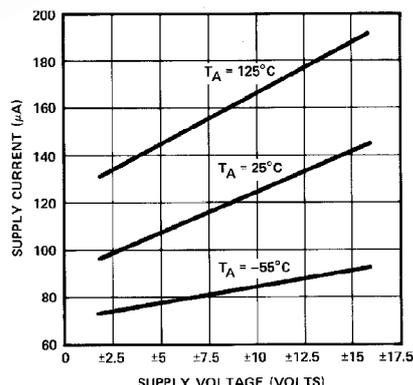

**CMRR vs FREQUENCY**

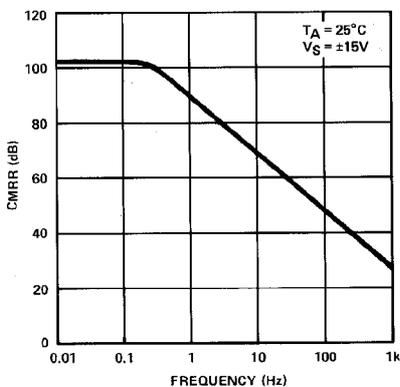

**PSRR vs FREQUENCY**

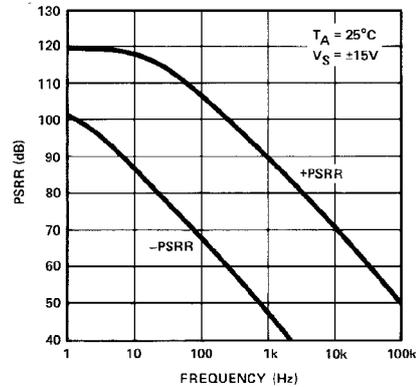

**MAXIMUM OUTPUT VOLTAGE vs LOAD RESISTANCE**

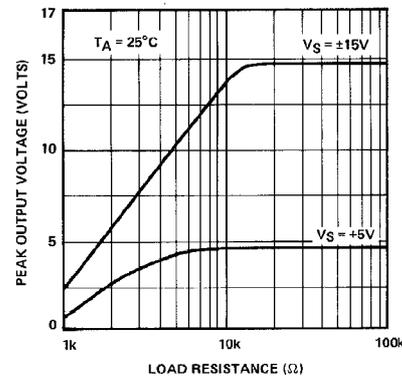

# OP-220

## TYPICAL PERFORMANCE CHARACTERISTICS

**OPEN-LOOP VOLTAGE GAIN AND PHASE vs FREQUENCY**

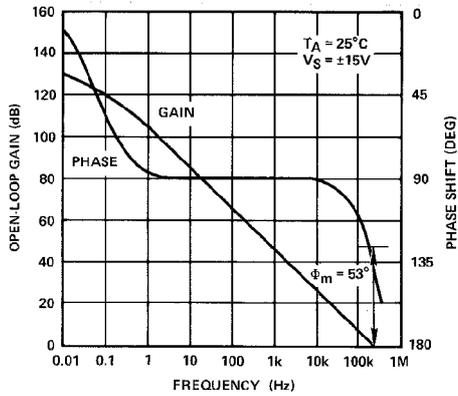

**MAXIMUM OUTPUT SWING vs FREQUENCY**

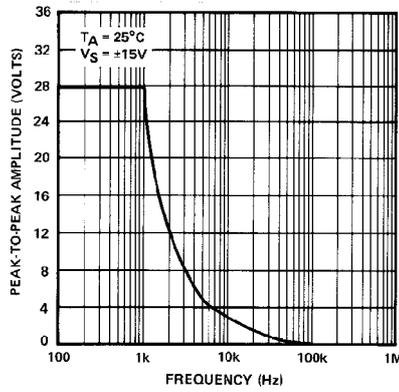

**SLEW RATE vs TEMPERATURE**

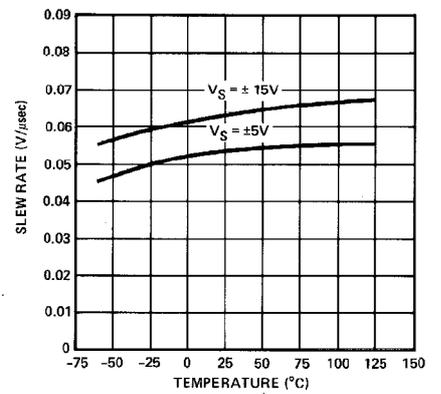

**VOLTAGE NOISE DENSITY ( $e_n$ ) vs FREQUENCY**

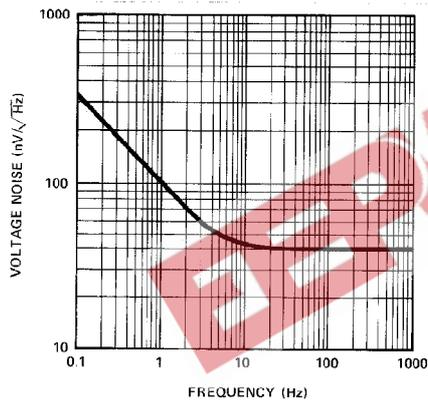

**CURRENT NOISE DENSITY ( $i_n$ ) vs FREQUENCY**

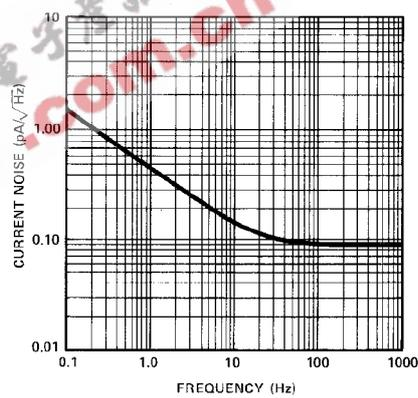

**SMALL-SIGNAL TRANSIENT RESPONSE**

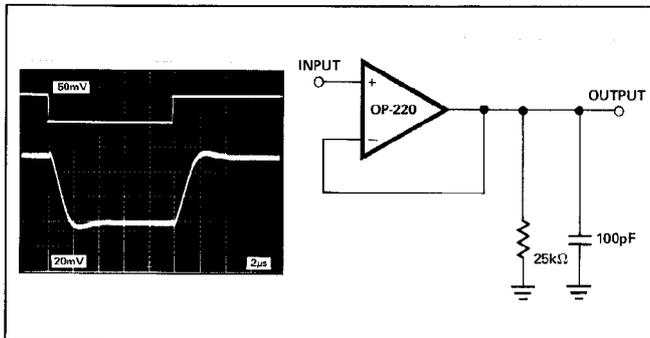

**LARGE-SIGNAL TRANSIENT RESPONSE**

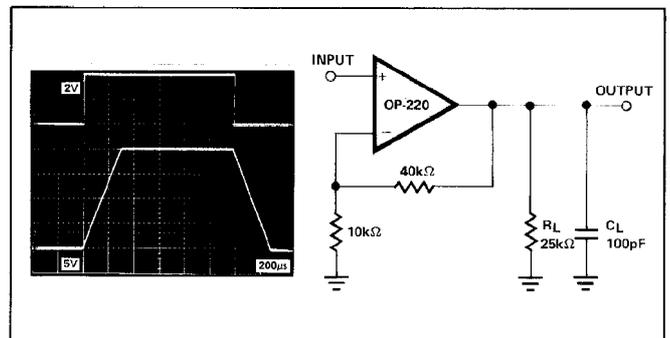

**INSTRUMENTATION AMPLIFIER APPLICATIONS OF THE OP-220**

**TWO-OP-AMP CONFIGURATION**

The excellent input characteristics of the OP-220 make it ideal for use in *instrumentation amplifier* configurations where low-level differential signals are to be amplified. The low-noise, low input offsets, low drift, and high gain combined with excellent CMRR provide the characteristics needed for high-performance instrumentation amplifiers. In addition, the power supply current drain is very low.

The circuit of Figure 1 is recommended for applications where the common-mode input range is relatively low and differential gain will be in the range of 10 to 1000. This two-op-amp instrumentation amplifier features *independent* adjustment of common-mode rejection and differential gain. Input impedance is very high since both inputs are applied to noninverting op amp inputs.

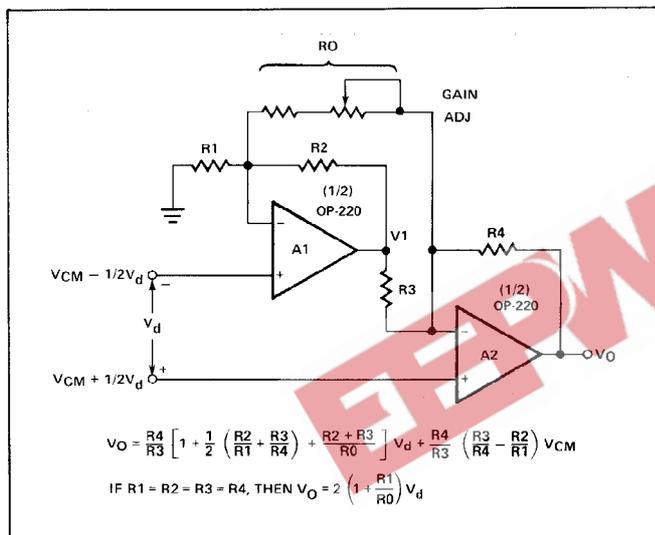

**Figure 1. Two-Op-Amp Instrumentation Amplifier Configuration**

The input voltages are represented as a common-mode input  $V_{CM}$  plus a differential input  $V_d$ . The ratio  $R_3/R_4$  is made equal to the ratio  $R_2/R_1$  to reject the common-mode input  $V_{CM}$ . The differential signal  $V_d$  is then amplified according to:

$$V_O = \frac{R_4}{R_3} \left( 1 + \frac{R_3}{R_4} + \frac{R_2 + R_3}{R_O} \right) V_d, \text{ where } \frac{R_3}{R_4} = \frac{R_2}{R_1}$$

Note that gain can be independently varied by adjusting  $R_O$ . From considerations of dynamic range, resistor tempco matching, and matching of amplifier response, it is generally best to make  $R_1, R_2, R_3,$  and  $R_4$  approximately equal. Designating  $R_1, R_2, R_3,$  and  $R_4$  as  $R_N$  allows the output equation to be further simplified:

$$V_O = 2 \left( 1 + \frac{R_N}{R_O} \right) V_d, \text{ where } R_N = R_1 = R_2 = R_3 = R_4$$

Dynamic range is limited by A1 as well as A2; the output of A1 is:

$$V_1 = - \left( 1 + \frac{R_N}{R_O} \right) V_d + 2 V_{CM}$$

If the instrumentation amplifier were designed for a gain of 10 and maximum  $V_d$  of  $\pm 1V$ , then  $R_N/R_O$  would need to be four and  $V_O$  would be a maximum of  $\pm 10V$ . Amplifier A1 would have a maximum output of  $\pm 5V$  plus  $2V_{CM}$ , thus a limit of  $\pm 10V$  on the output of A1 would imply a limit of  $\pm 2.5V$  on  $V_{CM}$ .

A nominal value of  $100k\Omega$  for  $R_N$  is suitable for most applications. A range of  $200\Omega$  to  $25k\Omega$  for  $R_O$  will then provide a gain range of 10 to 1000. The current through  $R_O$  is  $V_d/R_O$ , so the amplifiers must supply  $\pm 10mV/200\Omega$  when the gain is at the maximum value of 1000 and  $V_d$  is at  $\pm 10mV$ .

Rejecting common-mode inputs is most important in accurately amplifying low-level differential signals. Two factors determine the CMR of this instrumentation amplifier configuration (assuming infinite gain):

- (1) CMRR of the op amps
- (2) Matching of the resistor network ( $R_3/R_4 = R_2/R_1$ )

In this instrumentation amplifier configuration, error due to CMRR effect is directly proportional to the *differential* CMRR of the op amps. For the OP-220A/E, this combined CMRR is a minimum of 98dB. A combined CMRR value of 100dB and common-mode input range of  $\pm 2.5V$  indicates a peak input-referred error of only  $\pm 25\mu V$ .

Resistor matching is the other factor affecting CMRR. Defining  $A_d$  as the differential gain of the instrumentation amplifier and assuming that  $R_1, R_2, R_3$  and  $R_4$  are approximately equal ( $R_N$  will be the nominal value), then CMRR will be approximately  $A_d$  divided by  $4\Delta R/R_N$ . CMRR at differential gain of 100 would be 88dB with resistor matching of 0.1%. Trimming  $R_1$  to make the ratio  $R_3/R_4$  equal to  $R_2/R_1$  will directly raise the CMRR until it is limited by linearity and resistor stability considerations.

The high open-loop gain of the OP-220 is very important in achieving high accuracy in the two-op-amp instrumentation amplifier configuration. Gain error can be approximated by:

$$\text{Gain Error} \sim \frac{1}{1 + \frac{A_d}{A_{02}}}, \quad \left| \frac{A_d}{2 A_{01} A_{02}} \right| \ll 1$$

where  $A_d$  is the instrumentation amplifier differential gain and  $A_{02}$  is the open-loop gain of op amp A2. This analysis assumes equal values of  $R_1, R_2, R_3,$  and  $R_4$ . For example, consider an OP-220 with  $A_{02}$  of 700V/mV. If the differential gain  $A_d$  were set to 700, the gain error would be 1/1.001 which is approximately 0.1%.

Another effect of finite op amp gain is undesired feedthrough of common-mode input. Defining  $A_{01}$  as the open-loop gain of op amp A1, then the common-mode error (CME) at the output due to this effect will be approximately

$$\text{CME} \sim \frac{2 A_d}{1 + \frac{A_d}{A_{01}}} \frac{1}{A_{01}} V_{CM}$$

## OP-220

For  $A_d/A_{01} \ll 1$ , this simplifies to  $(2A_d/A_{01}) \times V_{CM}$ . If the op amp gain is 700V/mV,  $V_{CM}$  is 2.5V, and  $A_d$  is set to 700, then the error at the output due to this effect will be approximately 5mV.

The OP-220 offers a unique combination of excellent dc performance, wide input range, and low supply current drain that is particularly attractive for instrumentation amplifier design.

### THREE-OP-AMP CONFIGURATION

A three-op-amp instrumentation amplifier configuration using the OP-220 and OP-22 is recommended for applications requiring high accuracy over a wide gain range. This

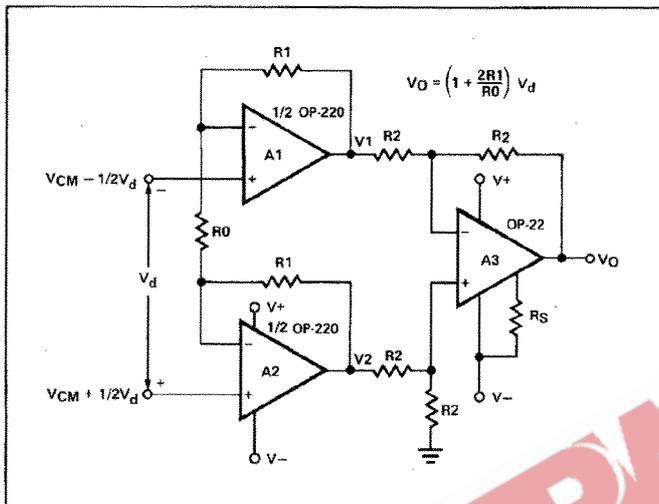

Figure 2. Three-Op-Amp Instrumentation Amplifier Using OP-220 and OP-22

circuit provides excellent CMR over a wide input range. As with the two-op-amp instrumentation amplifier circuits, tight matching of the two op amps provides a real boost in performance. The OP-22 is a micropower op-amp featuring programmable supply current.

A simplified schematic is shown in Figure 2. The input stage (A1 and A2) serves to amplify the differential input  $V_d$  without amplifying the common-mode voltage  $V_{CM}$ . The output stage then rejects the common-mode input. With ideal op-amps and no resistor matching errors, the outputs of each amplifier will be:

$$V_1 = -\left(1 + \frac{2R_1}{R_0}\right) \frac{V_d}{2} + V_{CM}$$

$$V_2 = \left(1 + \frac{2R_1}{R_0}\right) \frac{V_d}{2} + V_{CM}$$

$$V_O = V_2 - V_1 = \left(1 + \frac{2R_1}{R_0}\right) V_d$$

$$V_O = A_d V_d$$

The differential gain  $A_d$  is  $1 + 2R_1/R_0$  and the common-mode input  $V_{CM}$  is rejected.

This three-op-amp instrumentation amplifier configuration using an OP-220 at the input and an OP-22 at the output provides excellent performance over a wide gain range with very low power consumption. A gain range of 1 to 2000 is practical and CMR of over 120dB is readily achievable.