

ISOLATED HERMETIC TO-258AA FIXED POSITIVE VOLTAGE REGULATORS

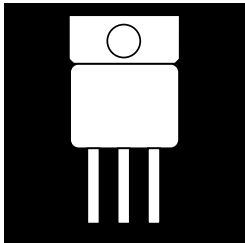

Three Terminal, Fixed Positive Voltage, 3.0 Amp Precision Positive Regulator In Hermetic JEDEC TO-258AA Package

FEATURES

- Isolated Hermetic Package. JEDEC TO-258AA Outline
- Output Voltages: 5V, 12V And 15V (Other Voltages Available)
- Output Voltages Set Internally To $\pm 2\%$ ($\pm 1\%$ Available)
- Built-In Thermal Overload Protection
- Short Circuit Current Limiting
- Product Is Available Hi-Rel Screened

DESCRIPTION

These three terminal positive regulators are supplied in a hermetically sealed metal package whose outline is similar to the industry standard TO-247 plastic package. All protective features are designed into the circuit, including thermal shutdown, current limiting and safe-area control. With heat sinking, they can deliver over 3.0 amps of output current. These units feature $\pm 2\%$ initial voltage tolerance, with 0.3% load regulation and .01% line regulation.

ABSOLUTE MAXIMUM RATINGS @ 25°C

Input to Output Voltage Differential +35V
 Operating Junction Temperature Range - 55°C to + 150°C
 Storage Temperature Range - 55°C to + 150°C

Typical Power/Thermal Characteristics:

Rated Power @ 25°C

T_C 25W
 T_A 3W

Thermal Resistance:

θ_{JC} 3.5°C/W
 θ_{JA} 42°C/W

3.3

Note: For $\pm 1\%$ device, add letter "A" in front of part number (e.g. OMA 7662SC).

OM7662SC - OM7664SC

ELECTRICAL CHARACTERISTICS: 5 VOLT OUTPUT (OM7662SC)

Parameter	Test Conditions	Min.	Typ.	Max.	Units
V _{OUT}	T _J = 25°C, V _{IN} = 12 V, I _O = 10 mA	4.90	5.00	5.10	V
	8.0 V V _{IN} 35 V, 10 mA I _O 3 A; P 25 W	4.80	5.00	5.20	
Line Regulation (Note 1)	8.0 V V _{IN} 35 V	-	.03	.06	%/V
Load Regulation	10 mA I _O 3.0 A	-	20	55	mV
Thermal Regulation	T _A = 25°C, 20 mS Pulse	-	.005	.013	%/W
Ripple Rejection	f = 120 Hz; V _{OUT} = 5 V	-	65	-	dB
Minimum Load		-	-	10	mA
Current Limit	V _{IN} = 13 V, T _J = 25°C	3	4.5	-	A
Temperature Stability		-	1.0	2.0	%
RMS Output Noise	T _A = 25°C, 10 Hz f 10 kHz	-	.001	-	%

Note 1: Regulation is measured at a constant T_J. Changes in output due to heating must be taken into account separately. Pulse testing with low duty cycle is used.

ELECTRICAL CHARACTERISTICS: 12 VOLT OUTPUT (OM7663SC)

Parameter	Test Conditions	Min.	Typ.	Max.	Units
V _{OUT}	T _J = 25°C, V _{IN} = 18 V, I _O = 10 mA	11.76	12.00	12.24	V
	15 V V _{IN} 35 V, 10 mA I _O 3 A; P 25 W	11.53	12.00	12.48	
Line Regulation (Note 1)	15 V V _{IN} 35 V	-	.03	.06	%/V
Load Regulation	10 mA I _O 3.0 A	-	60	132	mV
Thermal Regulation	T _A = 25°C, 20 mS Pulse	-	.005	.013	%/W
Ripple Rejection	f = 120 Hz; V _{OUT} = 12 V	-	65	-	dB
Minimum Load		-	-	10	mA
Current Limit	V _{IN} = 20 V, T _J = 25°C	3	4.5	-	A
Temperature Stability		-	1.0	2.0	%
RMS Output Noise	T _A = 25°C, 10 Hz f 10 kHz	-	.001	-	%

Note 1: Regulation is measured at a constant T_J. Changes in output due to heating must be taken into account separately. Pulse testing with low duty cycle is used.

ELECTRICAL CHARACTERISTICS: 15 VOLT OUTPUT (OM7664SC)

Parameter	Test Conditions	Min.	Typ.	Max.	Units
V _{OUT}	T _J = 25°C, V _{IN} = 23 V, I _O = 10 mA	14.70	15.00	15.3	V
	18 V V _{IN} 35 V, 10 mA I _O 3 A; P 25 W	14.41	15.00	15.60	
Line Regulation (Note 1)	18 V V _{IN} 35 V	-	.03	.06	%/V
Load Regulation	10 mA I _O 3.0 A	-	75	165	mV
Thermal Regulation	T _A = 25°C, 20 mS Pulse	--	.005	.013	%/W
Ripple Rejection	f = 120 Hz; V _{OUT} = 15 V		65		dB
Minimum Load		-	-	10	mA
Current Limit	V _{IN} = 23 V, T _J = 25°C	3	4.5	-	A
Temperature Stability		-	1.0	2.0	%
RMS Output Noise	T _A = 25°C, 10 Hz f 10 kHz	-	.001	-	%

Note 1: Regulation is measured at a constant T_J. Changes in output due to heating must be taken into account separately. Pulse testing with low duty cycle is used.

Current Limit

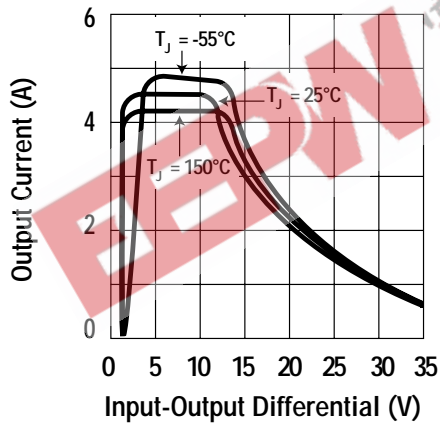

Dropout Voltage

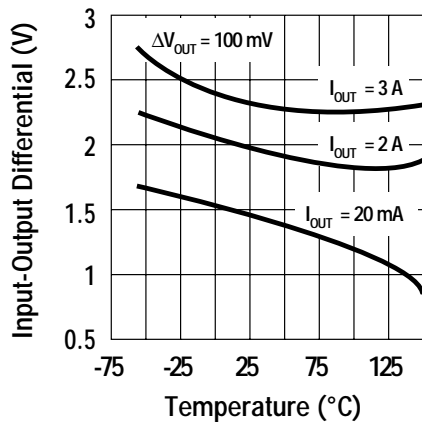

Ripple Rejection

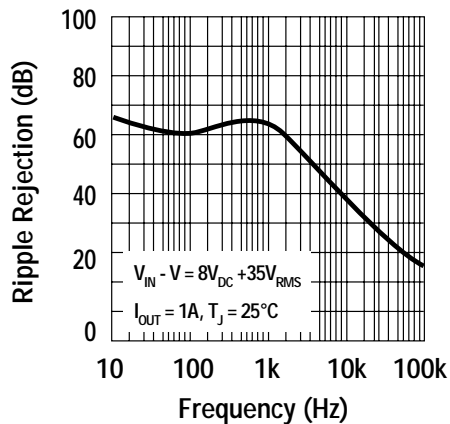

3.3

TYPICAL APPLICATIONS

Fixed Output Regulator

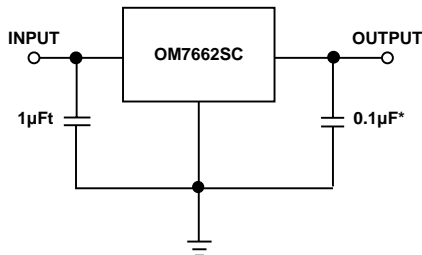

*Increasing value of output capacitor improves system transient response.
 †Required only if regulator is located an appreciable distance from power supply filter.

Circuit For Increasing Output Voltage

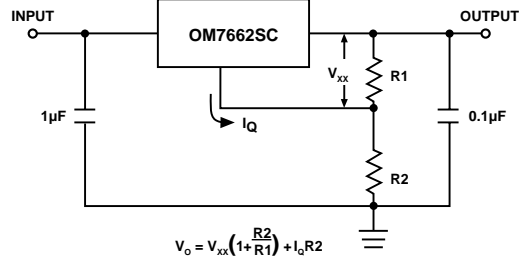

High Output Current, Short Circuit Protected

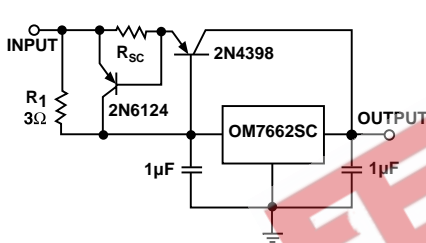

Adjustable Output Regulator, 7 To 30 Volts

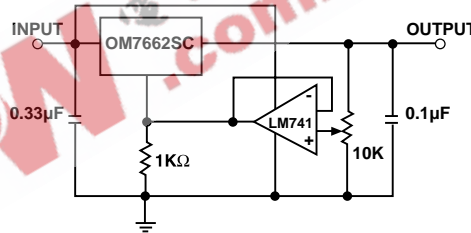

MECHANICAL OUTLINE

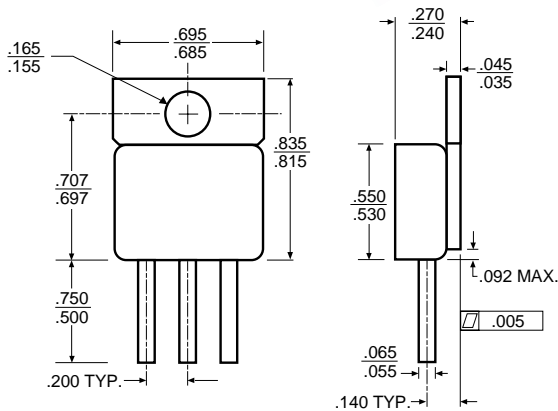

NOTES:

- Case is metal/hermetically sealed
- Isolated Tab

PIN CONNECTION

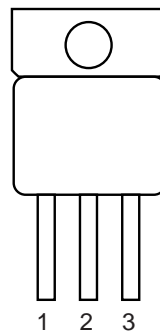

Front View
 Pin 1: Ground
 Pin 2: Output
 Pin 3: Input

This device is also available in a TO-257AA package. Call the factory for test conditions and limits.