



Dual Micropower Operational Amplifier

OP-220

FEATURES

- Excellent TCV_{OS} Match $2\mu V/^{\circ}C$ Max
- Low Input Offset Voltage $150\mu V$ Max
- Low Supply Current $100\mu A$
- Single-Supply Operation $+5V$ to $+30V$
- Low Input Offset Voltage Drift $0.75\mu V/^{\circ}C$
- High Open-Loop Gain $2000V/mV$
- High PSRR $3\mu V/V$
- Low Input Bias Current $12nA$
- Wide Common-Mode Voltage Range $V-$ to within $1.5V$ of $V+$
- Pin Compatible with 1458, LM158, LM2904
- Available in Die Form

GENERAL DESCRIPTION

The OP-220 is a monolithic dual operational amplifier that can be used either in single or dual supply operation. The low offset voltage, and input offset voltage tracking as low as $1.0\mu V/^{\circ}C$, make this the first micropower precision dual operational amplifier.

The excellent specifications of the individual amplifiers combined with the tight matching and temperature tracking between channels provides high performance in instrumentation amplifier designs. The individual amplifiers feature extremely low input offset voltage, low offset voltage drift, low noise voltage, and low bias current. They are fully compensated and protected.

Matching between channels is provided on all critical parameters including input offset voltage, tracking of offset voltage vs. temperature, non-inverting bias currents, and common-mode rejection ratios.

ORDERING INFORMATION [†]

$T_A = +25^{\circ}C$ V_{OS} MAX (μV)	PACKAGE			OPERATING TEMPERATURE RANGE
	TO-99	CERDIP 8-PIN	PLASTIC 8-PIN	
150	OP220AJ*	OP220AZ	—	MIL
150	—	OP220EZ	—	IND
300	—	OP220FZ	—	IND
750	OP220CJ*	OP220CZ	—	MIL
750	OP220GJ	OP220GZ	OP220GP	XIND
750	—	—	OP220GS	XIND

* For devices processed in total compliance to MIL-STD-883, add /883 after part number. Consult factory for 883 data sheet.

[†] Burn-in is available on commercial and industrial temperature range parts in CerDIP, plastic DIP, and TO-can packages.

PIN CONNECTIONS

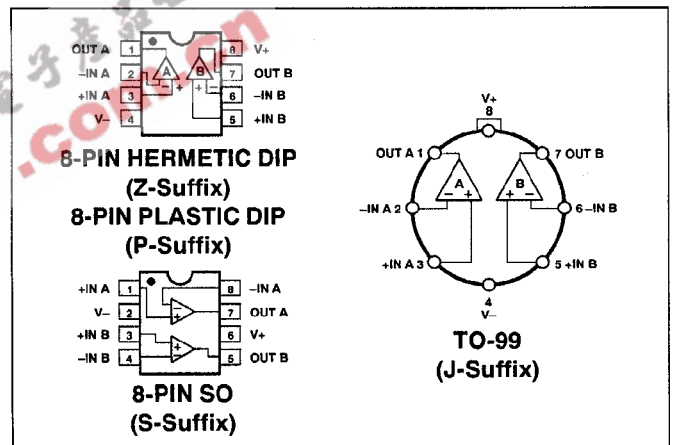

SIMPLIFIED SCHEMATIC (Each Amplifier)

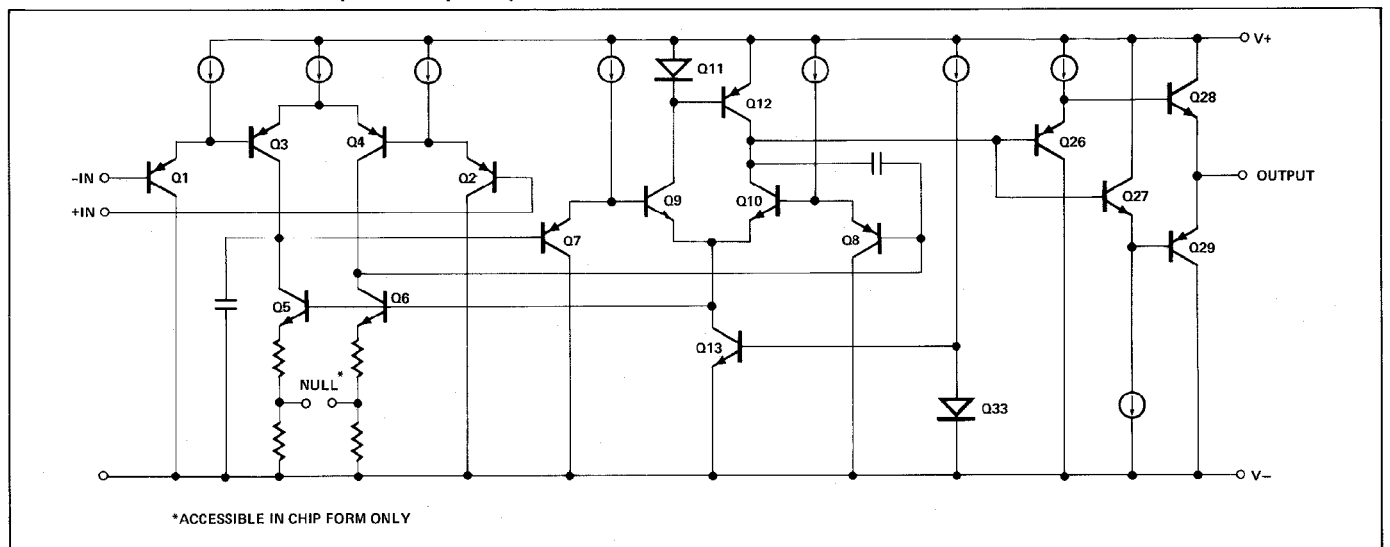

OP-220

ABSOLUTE MAXIMUM RATINGS (Note 1)

Supply Voltage	±18V
Differential Input Voltage	30V or Supply Voltage
Input Voltage	Supply Voltage
Output Short-Circuit Duration	Indefinite
Storage Temperature Range	-65°C to +150°C
Operating Temperature Range	
OP-220A, C	-55°C to +125°C
OP-220E, F	-25°C to +85°C
OP-220G	-40°C to +85°C
Lead Temperature (Soldering, 60 sec)	+300°C
Junction Temperature (T _J)	-65°C to +150°C

PACKAGE TYPE	Θ _{JA} (Note 2)	Θ _{JC}	UNITS
TO-99 (J)	150	18	°C/W
8-Pin Hermetic DIP (Z)	148	18	°C/W
8-Pin Plastic DIP (P)	103	43	°C/W
8-Pin SO (S)	158	43	°C/W

NOTES:

1. Absolute maximum ratings apply to both DICE and packaged parts, unless otherwise noted.
2. Θ_{JA} is specified for worst case mounting conditions, i.e., Θ_{JA} is specified for device in socket for CerDIP and P-DIP packages; Θ_{JA} is specified for device soldered to printed circuit board for SO package.

ELECTRICAL CHARACTERISTICS at V_S = ±2.5V to ±15V, T_A = +25°C, unless otherwise noted.

PARAMETER	SYMBOL	CONDITIONS	OP-220A/E			OP-220F			OP-220C/G			UNITS
			MIN	TYP	MAX	MIN	TYP	MAX	MIN	TYP	MAX	
Input Offset Voltage	V _{OS}	V _S = ±2.5V to ±15V	—	120	150	—	250	300	—	500	750	μV
Input Offset Current	I _{OS}	V _{CM} = 0	—	0.15	1.5	—	0.2	2	—	0.2	3.5	nA
Input Bias Current	I _B	V _{CM} = 0	—	12	20	—	13	25	—	14	30	nA
Input Voltage Range	IVR	V ₊ = 5V, V ₋ = 0V, V _S = ±15V	0/3.5 -15/13.5	—	—	0/3.5 -15/13.5	—	—	0/3.5 -15/13.5	—	—	V
Common-Mode Rejection Ratio	CMRR	V ₊ = 5V, V ₋ = 0V, 0V ≤ V _{CM} ≤ 3.5V	90	100	—	85	90	—	75	85	—	dB
		V _S = ±15V, -15V ≤ V _{CM} ≤ 13.5V	95	100	—	90	95	—	80	90	—	
Power Supply Rejection Ratio	PSRR	V _S = ±2.5V to ±15V	—	3	10	—	10	32	—	32	100	μV/V
		V ₋ = 0V, V ₊ = 5V to 30V	—	6	18	—	18	57	—	57	180	
Large-Signal Voltage Gain	A _{VO}	V ₊ = 5V, V ₋ = 0V, R _L = 100kΩ 1V ≤ V _O ≤ 3.5V	500	1000	—	500	800	—	300	500	—	V/mV
		V _S = ±15V, R _L = 25kΩ	1000	2000	—	1000	2000	—	800	1600	—	
		V _O = ±10V	—	—	—	—	—	—	—	—	—	
Output Voltage Swing	V _O	V ₊ = 5V, V ₋ = 0V, R _L = 10kΩ	0.7/4	—	—	0.7/4	—	—	0.8/4	—	—	V
		V _S = ±15V, R _L = 25kΩ	±14	—	—	±14	—	—	±14	—	—	
Slew Rate	SR	R _L = 25kΩ, (Note 1)	—	0.05	—	—	0.05	—	—	0.05	—	V/μs
Bandwidth	BW	A _{VCL} = +1, R _L = 25kΩ	—	200	—	—	200	—	—	200	—	kHz
Supply Current (Both Amplifiers)	I _{SY}	V _S = ±2.5V, No Load	—	100	115	—	115	125	—	125	135	μA
		V _S = ±15V, No Load	—	140	170	—	150	190	—	205	220	

ELECTRICAL CHARACTERISTICS at V_S = ±2.5V to ±15V, -55°C ≤ T_A ≤ +125°C for OP-220A and C, -25°C ≤ T_A ≤ +85°C for OP-220E and F, -40°C ≤ T_A ≤ +85°C for OP-220G, unless otherwise noted.

PARAMETER	SYMBOL	CONDITIONS	OP-220A/E			OP-220F			OP-220C/G			UNITS
			MIN	TYP	MAX	MIN	TYP	MAX	MIN	TYP	MAX	
Average Input Offset Voltage Drift (Note 1)	TCV _{OS}	V _S = ±15V	—	0.75	1.5	—	1.2	2	—	2	3	μV/°C
Input Offset Voltage	V _{OS}		—	200	300	—	400	500	—	1000	1300	μV
Input Offset Current	I _{OS}	V _{CM} = 0	—	0.5	2	—	0.6	2.5	—	0.8	5	nA
Input Bias Current	I _B	V _{CM} = 0	—	12	25	—	13	30	—	14	40	nA
Input Voltage Range	IVR	V ₊ = 5V, V ₋ = 0V, V _S = ±15V	0/3.2 -15/13.2	—	—	0/3.2 -15/13.2	—	—	0/3.2 -15/13.2	—	—	V
Common-Mode Rejection Ratio	CMRR	V ₊ = 5V, V ₋ = 0V, 0V ≤ V _{CM} ≤ 3.2V	85	90	—	80	85	—	70	80	—	dB
		V _S = ±15V	90	95	—	85	90	—	75	85	—	
		-15V ≤ V _{CM} ≤ 13.2V	—	—	—	—	—	—	—	—	—	
Power Supply Rejection Ratio	PSRR	V _S = ±2.5V to ±15V	—	6	18	—	18	57	—	57	180	μV/V
		V ₋ = 0V, V ₊ = 5V to 30V	—	10	32	—	32	100	—	100	320	

OP-220

ELECTRICAL CHARACTERISTICS at $V_S = \pm 2.5V$ to $\pm 15V$, $-55^\circ C \leq T_A \leq +125^\circ C$ for OP-220A and C, $-25^\circ C \leq T_A \leq +85^\circ C$ for OP-220E and F, $-40^\circ C \leq T_A \leq +85^\circ C$ for OP-220G, unless otherwise noted. *Continued*

PARAMETER	SYMBOL	CONDITIONS	OP-220A/E			OP-220F			OP-220C/G			UNITS
			MIN	TYP	MAX	MIN	TYP	MAX	MIN	TYP	MAX	
Large-Signal Voltage Gain	A_{VO}	$V_S = \pm 15V$, $R_L = 50k\Omega$ $V_O = \pm 10V$	500	1000	—	500	800	—	400	500	—	V/mV
Output Voltage Swing	V_O	$V_+ = 5V$, $V_- = 0V$, $R_L = 20k\Omega$	0.9/3.8	—	—	0.9/3.8	—	—	1/3.8	—	—	V
		$V_S = \pm 15V$, $R_L = 50k\Omega$	± 13.8	—	—	± 13.8	—	—	± 13.8	—	—	
Supply Current (Both Amplifiers)	I_{SY}	$V_S = \pm 2.5V$, No Load	—	135	170	—	155	185	—	170	210	μA
		$V_S = \pm 15V$, No Load	—	190	250	—	200	280	—	275	330	

NOTE: 1. Sample tested.

MATCHING CHARACTERISTICS at $V_S = \pm 15V$, $T_A = 25^\circ C$, unless otherwise noted.

PARAMETER	SYMBOL	CONDITIONS	OP-220A/E			OP-220F			OP-220C/G			UNITS
			MIN	TYP	MAX	MIN	TYP	MAX	MIN	TYP	MAX	
Input Offset Voltage Match	ΔV_{OS}		—	150	300	—	250	500	—	300	600	μV
Average Noninverting Bias Current	I_{B^+}	$V_{CM} = 0$	—	10	20	—	15	25	—	20	30	nA
Noninverting Offset Current	I_{OS^+}	$V_{CM} = 0$	—	0.7	1.5	—	1	2	—	1.4	2.5	nA
Common-Mode Rejection Ratio Match (Note 1)	$\Delta CMRR$	$V_{CM} = -15V$ to $+13.5V$	92	100	—	87	95	—	72	85	—	dB
Power Supply Rejection Ratio Match (Note 2)	$\Delta PSRR$	$V_S = \pm 2.5V$ to $\pm 15V$	—	6	14	—	18	44	—	57	140	$\mu V/V$

MATCHING CHARACTERISTICS at $V_S = \pm 15V$, $-55^\circ C \leq T_A \leq +125^\circ C$ for OP-220A and C; $-25^\circ C \leq T_A \leq +85^\circ C$ for OP-220E and F; $-40^\circ C \leq T_A \leq +85^\circ C$ for OP-220G, unless otherwise noted. Grades E, F are sample tested.

PARAMETER	SYMBOL	CONDITIONS	OP-220A/E			OP-220F			OP-220C/G			UNITS
			MIN	TYP	MAX	MIN	TYP	MAX	MIN	TYP	MAX	
Input Offset Voltage Match	ΔV_{OS}		—	250	500	—	400	800	—	800	1800	μV
Input Offset Voltage Tracking	$TC\Delta V_{OS}$	(Note 3)	—	1	2	—	1.5	3	—	1.5	5	$\mu V/^\circ C$
Average Noninverting Bias Current	I_{B^+}	$V_{CM} = 0$	—	10	25	—	15	30	—	22	40	nA
Average Drift of Noninverting Bias Current	TCI_{B^+}	$V_{CM} = 0$ (Note 3)	—	15	25	—	15	30	—	30	50	$pA/^\circ C$
Noninverting Offset Current	I_{OS^+}	$V_{CM} = 0$	—	0.7	2	—	1	2.5	—	2.5	5	nA
Average Drift of Noninverting Offset Current	TCI_{OS^+}	$V_{CM} = 0$ (Note 3)	—	7	15	—	12	22.5	—	15	30	$pA/^\circ C$
Common-Mode Rejection Ratio Match (Note 1)	$\Delta CMRR$	$V_{CM} = -15V$ to $+13V$	87	98	—	82	96	—	72	80	—	dB
Power Supply Rejection Ratio Match (Note 2)	$\Delta PSRR$	$V_S = \pm 2.5V$ to $\pm 15V$	—	10	26	—	30	78	—	57	250	$\mu V/V$

NOTES:

1. $\Delta CMRR$ is $20 \log_{10} V_{CM}/\Delta CME$, where V_{CM} is the voltage applied to both noninverting inputs and ΔCME is the difference in common-mode input-referred error.

2. $\Delta PSRR$ is:
$$\frac{\text{Input-referred differential error}}{\Delta V_S}$$

3. Sample tested.

OP-220

DICE CHARACTERISTICS

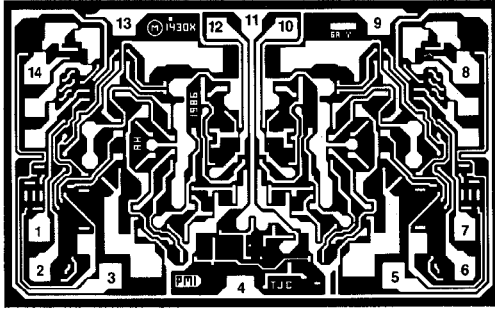

DIE SIZE 0.097 × 0.063 inch, 6111 sq. mils
(2.464 × 1.600 mm, 3.94 sq. mm)

NOTE: All V+ PADS ARE INTERNALLY CONNECTED.

1. INVERTING INPUT (A)
2. NONINVERTING INPUT (A)
3. BALANCE (A)
4. V-
5. BALANCE (B)
6. NONINVERTING INPUT (B)
7. INVERTING INPUT (B)
8. BALANCE (B)
9. V+
10. OUT (B)
11. V+
12. OUT (A)
13. V+
14. BALANCE (A)

WAFER TEST LIMITS at $V_S = \pm 2.5V$ to $\pm 15V$, $T_A = 25^\circ C$ for OP-220N, OP-220G and OP-220GR devices; $T_A = 125^\circ C$ for OP-221NT devices, unless otherwise noted.

PARAMETER	SYMBOL	CONDITIONS	OP-220NT LIMIT	OP-220N LIMIT	OP-220G LIMIT	OP-220GR LIMIT	UNITS
Input Offset Voltage	V_{OS}		350	200	500	1000	μV MAX
Input Offset Voltage Match	ΔV_{OS}		500	300	500	600	μV MAX
Input Offset Current	I_{OS}	$V_{CM} = 0$	2.5	2	3.5	5	nA MAX
Input Bias Current	I_B	$V_{CM} = 0$	30	25	30	40	nA MAX
Input Voltage Range	IVR	$V_S = \pm 15V$	-15/13.5	-15/13.5	-15/13.5	-15/13.5	V MIN
Common-Mode Rejection Ratio	CMRR	$V_- = 0V, V_+ = 5V, 0V \leq V_{CM} \leq 3.5V$	83	88	83	75	dB MIN
		$-15V \leq V_{CM} \leq 13.5V, V_S = \pm 15V$	88	93	88	80	
Power Supply Rejection Ratio	PSRR	$V_S = \pm 2.5V$ to $\pm 15V$	22	12.5	40	100	$\mu V/V$ MAX
		$V_- = 0V, V_+ = 5V$ to 30V	36	22.5	70	180	
Large-Signal Voltage Gain	A_{VO}	$R_L = 25k\Omega, V_S = \pm 15V$ $V_O = \pm 10V$	—	1000	800	500	V/mV MIN
		$V_S = \pm 15V, R_L = 50k\Omega$ $V_O = \pm 10V$	500	—	—	—	
Output Voltage Swing	V_O	$V_+ = 5V, V_- = 0V, R_L = 10k\Omega$ $V_S = \pm 15V, R_L = 25k\Omega$	—	0.7/4	0.8/4	0.8/3.8	V MIN
		$V_+ = 5V, V_- = 0V,$ $R_L = 20k\Omega$	0.9/3.8	—	—	—	
		$V_S = \pm 15V, R_L = 50k\Omega$	± 13.8	—	—	—	
Supply Current (Both Amplifiers)	I_{SY}	$V_S = \pm 2.5V, \text{No Load}$	170	125	135	170	μA MAX
		$V_S = \pm 15V, \text{No Load}$	250	190	220	300	

NOTE:

Electrical tests are performed at wafer probe to the limits shown. Due to variations in assembly methods and normal yield loss, yield after packaging is not guaranteed for standard product dice. Consult factory to negotiate specifications based on dice lot qualification through sample lot assembly and testing.

TYPICAL ELECTRICAL CHARACTERISTICS at $V_S = \pm 15V, T_A = +25^\circ C$, unless otherwise noted.

PARAMETER	SYMBOL	CONDITIONS	OP-220NT TYPICAL	OP-220N TYPICAL	OP-220G TYPICAL	OP-220GR TYPICAL	UNITS
Average Input Offset Voltage Drift	TCV_{OS}		1.5	1.5	2	3	$\mu V/^\circ C$
Large-Signal Voltage Gain	A_{VO}	$R_L = 25k\Omega$	2000	2000	1600	800	V/mV

TYPICAL PERFORMANCE CHARACTERISTICS

NORMALIZED OFFSET VOLTAGE vs TEMPERATURE

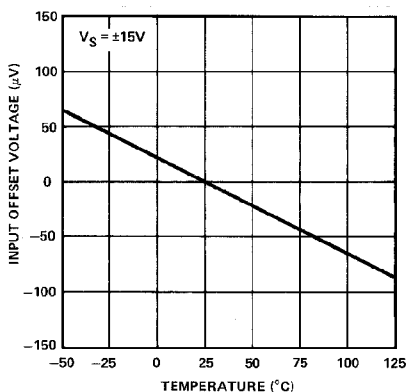

INPUT OFFSET VOLTAGE vs POWER SUPPLY VOLTAGE

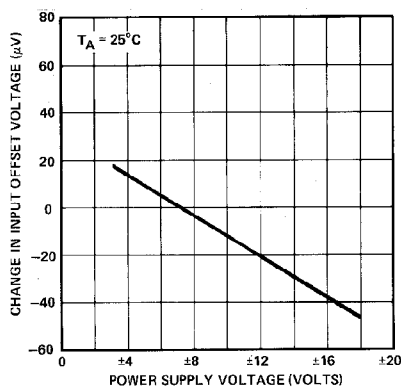

OPEN-LOOP GAIN vs TEMPERATURE

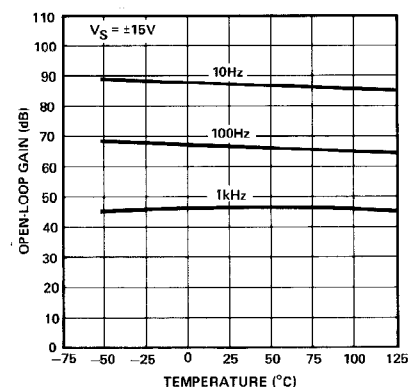

INPUT BIAS CURRENT vs TEMPERATURE

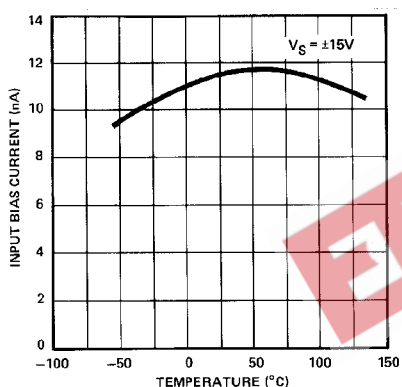

INPUT OFFSET CURRENT vs TEMPERATURE

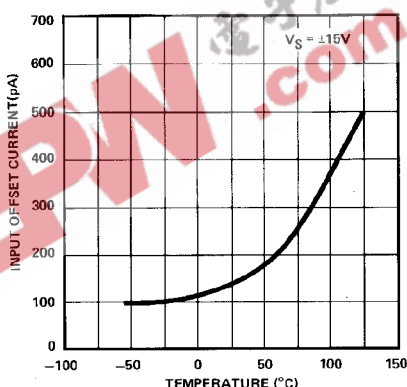

SUPPLY CURRENT vs SUPPLY VOLTAGE

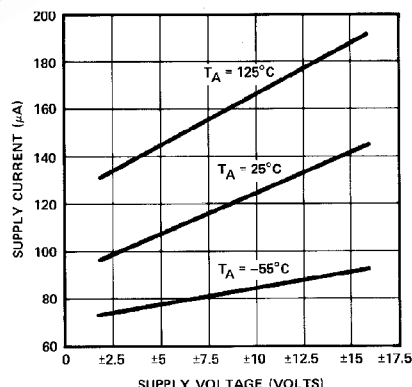

CMRR vs FREQUENCY

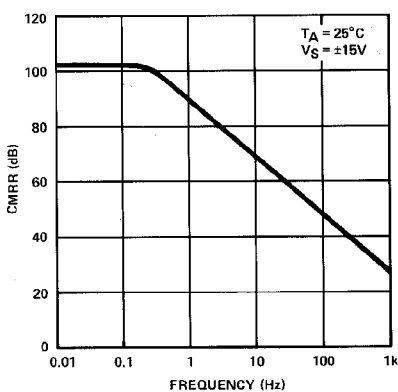

PSRR vs FREQUENCY

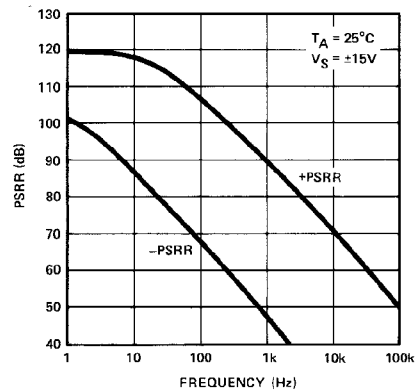

MAXIMUM OUTPUT VOLTAGE vs LOAD RESISTANCE

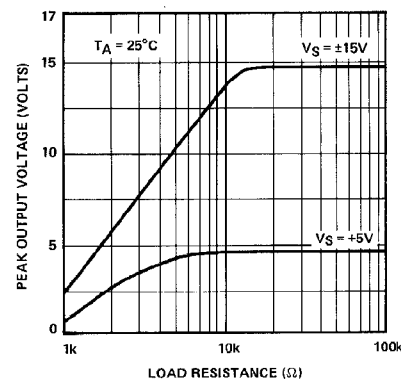

OP-220

TYPICAL PERFORMANCE CHARACTERISTICS

OPEN-LOOP VOLTAGE GAIN AND PHASE vs FREQUENCY

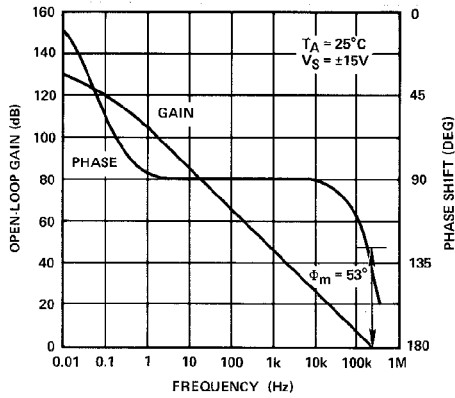

MAXIMUM OUTPUT SWING vs FREQUENCY

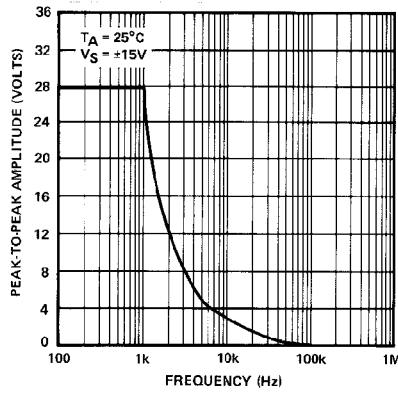

SLEW RATE vs TEMPERATURE

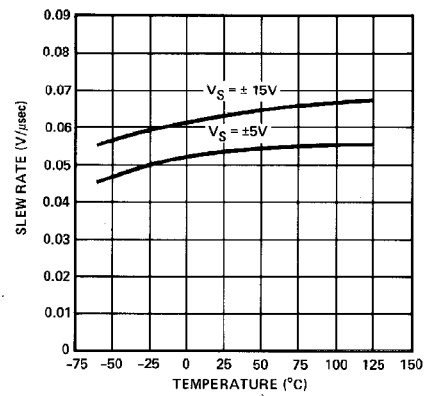

VOLTAGE NOISE DENSITY (e_n) vs FREQUENCY

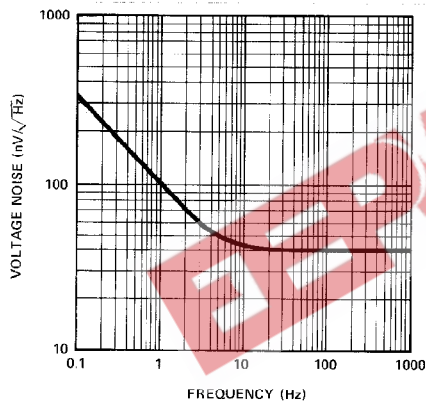

CURRENT NOISE DENSITY (i_n) vs FREQUENCY

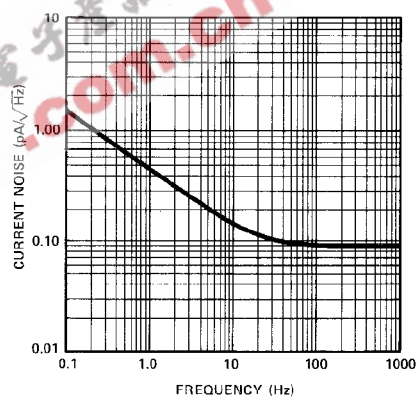

SMALL-SIGNAL TRANSIENT RESPONSE

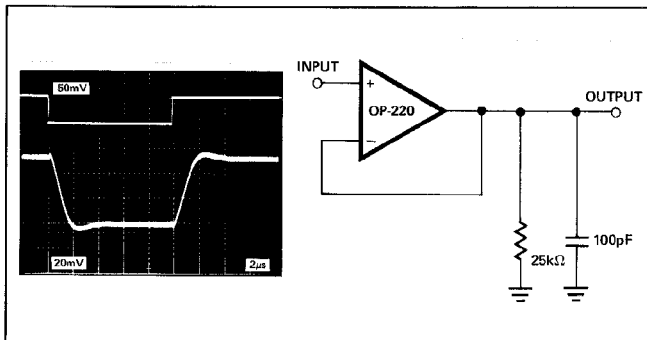

LARGE-SIGNAL TRANSIENT RESPONSE

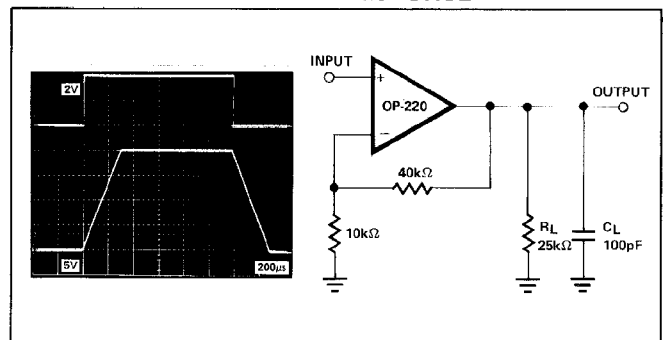

INSTRUMENTATION AMPLIFIER APPLICATIONS OF THE OP-220

TWO-OP-AMP CONFIGURATION

The excellent input characteristics of the OP-220 make it ideal for use in *instrumentation amplifier* configurations where low-level differential signals are to be amplified. The low-noise, low input offsets, low drift, and high gain combined with excellent CMRR provide the characteristics needed for high-performance instrumentation amplifiers. In addition, the power supply current drain is very low.

The circuit of Figure 1 is recommended for applications where the common-mode input range is relatively low and differential gain will be in the range of 10 to 1000. This two-op-amp instrumentation amplifier features *independent* adjustment of common-mode rejection and differential gain. Input impedance is very high since both inputs are applied to noninverting op amp inputs.

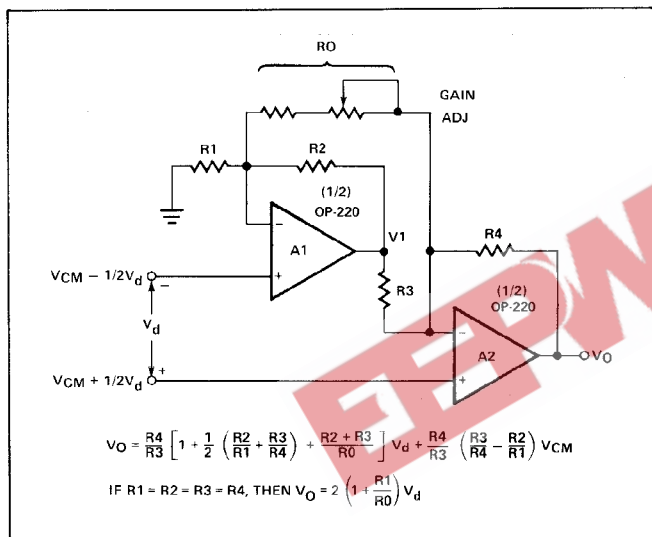

Figure 1. Two-Op-Amp Instrumentation Amplifier Configuration

The input voltages are represented as a common-mode input V_{CM} plus a differential input V_d . The ratio R_3/R_4 is made equal to the ratio R_2/R_1 to reject the common-mode input V_{CM} . The differential signal V_d is then amplified according to:

$$V_O = \frac{R_4}{R_3} \left(1 + \frac{R_3}{R_4} + \frac{R_2 + R_3}{R_O} \right) V_d, \text{ where } \frac{R_3}{R_4} = \frac{R_2}{R_1}$$

Note that gain can be independently varied by adjusting R_O . From considerations of dynamic range, resistor tempco matching, and matching of amplifier response, it is generally best to make $R_1, R_2, R_3,$ and R_4 approximately equal. Designating $R_1, R_2, R_3,$ and R_4 as R_N allows the output equation to be further simplified:

$$V_O = 2 \left(1 + \frac{R_N}{R_O} \right) V_d, \text{ where } R_N = R_1 = R_2 = R_3 = R_4$$

Dynamic range is limited by A1 as well as A2; the output of A1 is:

$$V_1 = - \left(1 + \frac{R_N}{R_O} \right) V_d + 2 V_{CM}$$

If the instrumentation amplifier were designed for a gain of 10 and maximum V_d of $\pm 1V$, then R_N/R_O would need to be four and V_O would be a maximum of $\pm 10V$. Amplifier A1 would have a maximum output of $\pm 5V$ plus $2V_{CM}$, thus a limit of $\pm 10V$ on the output of A1 would imply a limit of $\pm 2.5V$ on V_{CM} .

A nominal value of $100k\Omega$ for R_N is suitable for most applications. A range of 200Ω to $25k\Omega$ for R_O will then provide a gain range of 10 to 1000. The current through R_O is V_d/R_O , so the amplifiers must supply $\pm 10mV/200\Omega$ when the gain is at the maximum value of 1000 and V_d is at $\pm 10mV$.

Rejecting common-mode inputs is most important in accurately amplifying low-level differential signals. Two factors determine the CMR of this instrumentation amplifier configuration (assuming infinite gain):

- (1) CMRR of the op amps
- (2) Matching of the resistor network ($R_3/R_4 = R_2/R_1$)

In this instrumentation amplifier configuration, error due to CMRR effect is directly proportional to the *differential* CMRR of the op amps. For the OP-220A/E, this combined CMRR is a minimum of 98dB. A combined CMRR value of 100dB and common-mode input range of $\pm 2.5V$ indicates a peak input-referred error of only $\pm 25\mu V$.

Resistor matching is the other factor affecting CMRR. Defining A_d as the differential gain of the instrumentation amplifier and assuming that R_1, R_2, R_3 and R_4 are approximately equal (R_N will be the nominal value), then CMRR will be approximately A_d divided by $4\Delta R/R_N$. CMRR at differential gain of 100 would be 88dB with resistor matching of 0.1%. Trimming R_1 to make the ratio R_3/R_4 equal to R_2/R_1 will directly raise the CMRR until it is limited by linearity and resistor stability considerations.

The high open-loop gain of the OP-220 is very important in achieving high accuracy in the two-op-amp instrumentation amplifier configuration. Gain error can be approximated by:

$$\text{Gain Error} \sim \frac{1}{1 + \frac{A_d}{A_{02}}}, \quad \left| \frac{A_d}{2 A_{01} A_{02}} \right| \ll 1$$

where A_d is the instrumentation amplifier differential gain and A_{02} is the open-loop gain of op amp A2. This analysis assumes equal values of $R_1, R_2, R_3,$ and R_4 . For example, consider an OP-220 with A_{02} of 700V/mV. If the differential gain A_d were set to 700, the gain error would be 1/1.001 which is approximately 0.1%.

Another effect of finite op amp gain is undesired feedthrough of common-mode input. Defining A_{01} as the open-loop gain of op amp A1, then the common-mode error (CME) at the output due to this effect will be approximately

$$\text{CME} \sim \frac{2 A_d}{1 + \frac{A_d}{A_{01}}} \frac{1}{A_{01}} V_{CM}$$

OP-220

For $A_d/A_{01} \ll 1$, this simplifies to $(2 A_d/A_{01}) \times V_{CM}$. If the op amp gain is 700V/mV, V_{CM} is 2.5V, and A_d is set to 700, then the error at the output due to this effect will be approximately 5mV.

The OP-220 offers a unique combination of excellent dc performance, wide input range, and low supply current drain that is particularly attractive for instrumentation amplifier design.

THREE-OP-AMP CONFIGURATION

A three-op-amp instrumentation amplifier configuration using the OP-220 and OP-22 is recommended for applications requiring high accuracy over a wide gain range. This

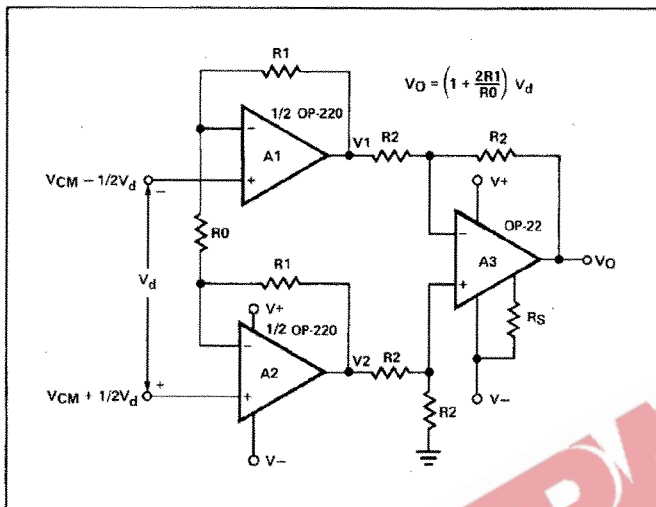

Figure 2. Three-Op-Amp Instrumentation Amplifier Using OP-220 and OP-22

circuit provides excellent CMR over a wide input range. As with the two-op-amp instrumentation amplifier circuits, tight matching of the two op amps provides a real boost in performance. The OP-22 is a micropower op-amp featuring programmable supply current.

A simplified schematic is shown in Figure 2. The input stage (A1 and A2) serves to amplify the differential input V_d without amplifying the common-mode voltage V_{CM} . The output stage then rejects the common-mode input. With ideal op-amps and no resistor matching errors, the outputs of each amplifier will be:

$$V_1 = -\left(1 + \frac{2R_1}{R_0}\right) \frac{V_d}{2} + V_{CM}$$

$$V_2 = \left(1 + \frac{2R_1}{R_0}\right) \frac{V_d}{2} + V_{CM}$$

$$V_O = V_2 - V_1 = \left(1 + \frac{2R_1}{R_0}\right) V_d$$

$$V_O = A_d V_d$$

The differential gain A_d is $1 + 2R_1/R_0$ and the common-mode input V_{CM} is rejected.

This three-op-amp instrumentation amplifier configuration using an OP-220 at the input and an OP-22 at the output provides excellent performance over a wide gain range with very low power consumption. A gain range of 1 to 2000 is practical and CMR of over 120dB is readily achievable.