

OM6001ST OM6003ST OM6101ST OM6103ST
OM6002ST OM6004ST OM6102ST OM6104ST

POWER MOSFET IN HERMETIC ISOLATED JEDEC TO-257AA PACKAGE

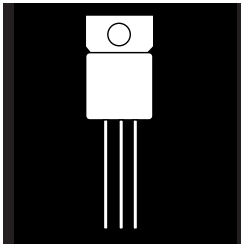

**100V Thru 500V, Up To 14 Amp, N-Channel
MOSFET With Or Without Zener Gate
Clamp Protection**

FEATURES

- Isolated Hermetic Metal Package
- Bi-Lateral Zener Gate Protection (Optional)
- Fast Switching, Low Drive Current
- Ease Of Paralleling For Added Power
- Low $R_{DS(on)}$
- Available Screened To MIL-S-19500, TX, TXV And S Levels

DESCRIPTION

This series of hermetically packaged products feature the latest advanced MOSFET and packaging technology. They are ideally suited for Military requirements where small size, high performance and high reliability are required, and in applications such as switching power supplies, motor controls, inverters, choppers, audio amplifiers and high energy pulse circuits. The MOSFET gates are protected using bi-lateral zener clamps in the OM6101ST series.

MAXIMUM RATINGS

PART NUMBER	V_{DS}	$R_{DS(on)}$	I_D
OM6001ST/OM6101ST	100 V	.20	14 A
OM6002ST/OM6102ST	200 V	.44	9 A
OM6003ST/OM6103ST	400 V	1.05	5.5 A
OM6004ST/OM6104ST	500 V	1.60	4.5 A

Note: OM6101ST thru OM6104ST is supplied with zener gate protection.
OM6001ST thru OM6004ST is supplied without zener gate protection.

3.1

SCHEMATIC

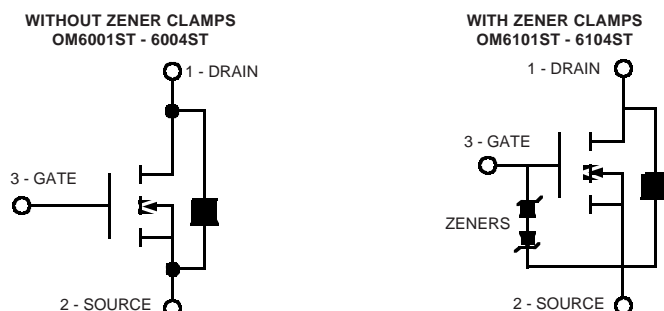

**ELECTRICAL CHARACTERISTICS: (T_C = 25°C unless otherwise noted)
STATIC P/N OM6101ST / OM6001ST (100V)**

Parameter	Min.	Typ.	Max.	Units	Test Conditions
BV _{DSS} Drain-Source Breakdown Voltage	100			V	V _{GS} = 0, I _D = 250 mA
V _{GS(th)} Gate-Threshold Voltage	2.0	4.0		V	V _{DS} = V _{GS} , I _D = 250 mA
I _{DSS} Gate-Body Leakage (OM6101)		± 500		nA	V _{GS} = ± 12.8 V
I _{DSS} Gate-Body Leakage (OM6001)		± 100		nA	V _{GS} = ± 20 V
I _{DSS} Zero Gate Voltage Drain Current		0.1	0.25	mA	V _{DS} = Max. Rat., V _{GS} = 0
I _{DSS} Current		0.2	1.0	mA	V _{DS} = 0.8 Max. Rat., V _{GS} = 0, T _C = 125°C
I _{D(on)} On-State Drain Current ¹	14			A	V _{DS} = 2 V _{DSS(on)} , V _{GS} = 10 V
V _{DS(on)} Static Drain-Source On-State Voltage ¹		1.2	1.60	V	V _{GS} = 10 V, I _D = 8 A
R _{DSS(on)} Static Drain-Source On-State Resistance ¹			0.20		V _{GS} = 10 V, I _D = 8 A
R _{DS(on)} Static Drain-Source On-State Resistance ¹			0.40		V _{GS} = 10 V, I _D = 8 A, T _C = 125°C

DYNAMIC

Parameter	Min.	Typ.	Max.	Units	Test Conditions
g _{fs} Forward Transconductance ¹	4.0			S (M)	V _{DS} = 2 V _{DSS(on)} , I _D = 8 A
C _{iss} Input Capacitance		750		pF	V _{GS} = 0
C _{oss} Output Capacitance		250		pF	V _{DS} = 25 V
C _{rss} Reverse Transfer Capacitance		100		pF	f = 1 MHz
t _{d(on)} Turn-On Delay Time		15		ns	V _{DD} = 30 V, I _D @ 8 A
t _r Rise Time		35		ns	
t _{d(off)} Turn-Off Delay Time		38		ns	R _g = 7.5 Ω, V _{DS} = 10 V
t _f Fall Time		23		ns	

BODY-DRAIN DIODE RATINGS AND CHARACTERISTICS

Parameter	Min.	Typ.	Max.	Units	Test Conditions
I _S Continuous Source Current (Body Diode)			-14	A	Modified MOSPOWER symbol showing the integral P-N Junction rectifier.
I _{SM} Source Current ¹ (Body Diode)			-56	A	T _C = 25°C, I _S = -14 A, V _{GS} = 0
V _{SD} Diode Forward Voltage ¹			-2.5	V	T _C = 25°C, I _S = -12 A, V _{GS} = 0
t _{rr} Reverse Recovery Time		100		ns	T _J = 150°C, I _F = I _S , dI _F /ds = 100 A/ms

1 Pulse Test: Pulse Width 300nsec, Duty Cycle 2%.

1 Pulse Test: Pulse Width 300nsec, Duty Cycle 2%.

**ELECTRICAL CHARACTERISTICS: (T_C = 25°C unless otherwise noted)
STATIC P/N OM6102ST / OM6002 ST (200V)**

Parameter	Min.	Typ.	Max.	Units	Test Conditions
BV _{DSS} Drain-Source Breakdown Voltage	200			V	V _{GS} = 0, I _D = 250 mA
V _{GS(th)} Gate-Threshold Voltage	2.0	4.0		V	V _{DS} = V _{GS} , I _D = 250 mA
I _{DSS} Gate-Body Leakage (OM6102)		± 500		nA	V _{GS} = ± 12.8 V
I _{DSS} Gate-Body Leakage (OM6002)		± 100		nA	V _{GS} = ± 20 V
I _{DSS} Zero Gate Voltage Drain Current		0.1	0.25	mA	V _{DS} = Max. Rat., V _{GS} = 0
I _{DSS} Current		0.2	1.0	mA	V _{DS} = 0.8 Max. Rat., V _{GS} = 0, T _C = 125°C
I _{D(on)} On-State Drain Current ¹	9.0			A	V _{DS} = 2 V _{DSS(on)} , V _{GS} = 10 V
V _{DS(on)} Static Drain-Source On-State Voltage ¹		1.25	2.2	V	V _{GS} = 10 V, I _D = 5.0 A
R _{DSS(on)} Static Drain-Source On-State Resistance ¹			0.44		V _{GS} = 10 V, I _D = 5.0 A
R _{DS(on)} Static Drain-Source On-State Resistance ¹			0.88		V _{GS} = 10 V, I _D = 5.0 A, T _C = 125°C

DYNAMIC

Parameter	Min.	Typ.	Max.	Units	Test Conditions
g _{fs} Forward Transconductance ¹	3.0	5.8		S (M)	V _{DS} = 2 V _{DSS(on)} , I _D = 5.0 A
C _{iss} Input Capacitance		780		pF	V _{GS} = 0
C _{oss} Output Capacitance		150		pF	V _{DS} = 25 V
C _{rss} Reverse Transfer Capacitance		55		pF	f = 1 MHz
t _{d(on)} Turn-On Delay Time		9		ns	V _{DD} = 75V, I _D @ 5.0 A
t _r Rise Time		18		ns	R _g = 7.5 Ω, V _{GS} = 10 V
t _{d(off)} Turn-Off Delay Time		45		ns	
t _f Fall Time		27		ns	

BODY-DRAIN DIODE RATINGS AND CHARACTERISTICS

Parameter	Min.	Typ.	Max.	Units	Test Conditions
I _S Continuous Source Current (Body Diode)			-9	A	Modified MOSPOWER symbol showing the integral P-N Junction rectifier.
I _{SM} Source Current ¹ (Body Diode)			-36	A	T _C = 25°C, I _S = -9 A, V _{GS} = 0
V _{SD} Diode Forward Voltage ¹			-2	V	T _C = 25°C, I _S = -8 A, V _{GS} = 0
t _{rr} Reverse Recovery Time		250		ns	T _J = 150°C, I _F = I _S , dI _F /ds = 100 A/ms

1 Pulse Test: Pulse Width 300nsec, Duty Cycle 2%.

1 Pulse Test: Pulse Width 300nsec, Duty Cycle 2%.

**ELECTRICAL CHARACTERISTICS: (T_C = 25°C unless otherwise noted)
STATIC P/N OM6103ST / OM6003ST (400V)**

Parameter	Min.	Typ.	Max.	Units	Test Conditions
BV _{DSS} Drain-Source Breakdown Voltage	400			V	V _{GS} = 0, I _b = 250 mA
V _{GS(th)} Gate-Threshold Voltage	2.0	4.0		V	V _{DS} = V _{GS} , I _b = 250 mA
I _{SS} Gate-Body Leakage		± 500		nA	V _{GS} = ± 12.8 V
I _{SS} Gate-Body Leakage		± 100		nA	V _{GS} = ± 20 V
I _{DSS} Zero Gate Voltage Drain Current		0.1	0.25	mA	V _{DS} = Max. Rat., V _{GS} = 0
Current		0.2	1.0	mA	V _{DS} = 0.8 Max. Rat., V _{GS} = 0, T _C = 125°C
I _{D(on)} On-State Drain Current ¹	5.5			A	V _{DS} = 2 V _{DS(on)} , V _{GS} = 10 V
V _{DS(on)} Static Drain-Source On-State Voltage ¹		2.4	3.15	V	V _{GS} = 10 V, I _b = 3.0 A
R _{DS(on)} Static Drain-Source On-State Resistance ¹		1.05			V _{GS} = 10 V, I _b = 3.0 A
R _{DS(on)} Static Drain-Source On-State Resistance ¹		2.0			V _{GS} = 10 V, I _b = 3.0 A, T _C = 125°C

DYNAMIC

g _{fs} Forward Transconductance ¹	3.0	3.6		S (M)	V _{DS} = 2 V _{DS(on)} , I _b = 3.0 A
C _{iss} Input Capacitance		700		pF	V _{GS} = 0
C _{oss} Output Capacitance		70		pF	V _{DS} = 25 V
C _{res} Reverse Transfer Capacitance		20		pF	f = 1 MHz
t _{di(on)} Turn-On Delay Time		18		ns	V _{DD} = 175 V, I _b @ 3.0 A
t _r Rise Time		20		ns	R _g = 10 n, V _{GS} = 10 V
t _{di(off)} Turn-Off Delay Time		40		ns	
t _f Fall Time		25		ns	

BODY-DRAIN DIODE RATINGS AND CHARACTERISTICS

I _S Continuous Source Current (Body Diode)		- 5.5		A	Modified MOSPOWER symbol showing the integral P-N Junction rectifier.
I _{SM} Source Current ¹ (Body Diode)		- 22		A	
V _{SD} Diode Forward Voltage ¹		- 1.6		V	T _C = 25°C, I _S = -5.5 A, V _{GS} = 0
					T _C = 25°C, I _S = -4.5 A, V _{GS} = 0
t _{rr} Reverse Recovery Time	470			ns	T _J = 150°C, I _F = I _S , dI _F /dI _S = 100 A/ms

1 Pulse Test: Pulse Width 300msec, Duty Cycle 2%.

1 Pulse Test: Pulse Width 300msec, Duty Cycle 2%.

**ELECTRICAL CHARACTERISTICS: (T_C = 25°C unless otherwise noted)
STATIC P/N OM6104ST / OM6004ST (500V)**

Parameter	Min.	Typ.	Max.	Units	Test Conditions
BV _{DSS} Drain-Source Breakdown Voltage	500			V	V _{GS} = 0, I _b = 250 mA
V _{GS(th)} Gate-Threshold Voltage	2.0	4.0		V	V _{DS} = V _{GS} , I _b = 250 mA
I _{SS} Gate-Body Leakage		± 500		nA	V _{GS} = ± 12.8 V
I _{SS} Gate-Body Leakage		± 100		nA	V _{GS} = ± 20 V
I _{DSS} Zero Gate Voltage Drain Current		0.1	0.25	mA	V _{DS} = Max. Rat., V _{GS} = 0
Current		0.2	1.0	mA	V _{DS} = 0.8 Max. Rat., V _{GS} = 0, T _C = 125°C
I _{D(on)} On-State Drain Current ¹	4.5			A	V _{DS} = 2 V _{DS(on)} , V _{GS} = 10 V
V _{DS(on)} Static Drain-Source On-State Voltage ¹		3.25	4.00	V	V _{GS} = 10 V, I _b = 2.5 A
R _{DS(on)} Static Drain-Source On-State Resistance ¹		1.6			V _{GS} = 10 V, I _b = 2.5 A
R _{DS(on)} Static Drain-Source On-State Resistance ¹		2.9	3.3		V _{GS} = 10 V, I _b = 2.5 A, T _C = 125°C

DYNAMIC

g _{fs} Forward Transconductance ¹	2.5	2.8		S (M)	V _{DS} = 2 V _{DS(on)} , I _b = 2.5 A
C _{iss} Input Capacitance		700		pF	V _{GS} = 0
C _{oss} Output Capacitance		90		pF	V _{DS} = 25 V
C _{res} Reverse Transfer Capacitance		30		pF	f = 1 MHz
t _{di(on)} Turn-On Delay Time		18		ns	V _{DD} = 225 V, I _b @ 2.5 A
t _r Rise Time		20		ns	R _g = 7.5 n, V _{GS} = 10 V
t _{di(off)} Turn-Off Delay Time		42		ns	
t _f Fall Time		25		ns	

BODY-DRAIN DIODE RATINGS AND CHARACTERISTICS

I _S Continuous Source Current (Body Diode)		- 4.5		A	Modified MOSPOWER symbol showing the integral P-N Junction rectifier.
I _{SM} Source Current ¹ (Body Diode)		- 18		A	
V _{SD} Diode Forward Voltage ¹		- 1.4		V	T _C = 25°C, I _S = -4.5 A, V _{GS} = 0
					T _C = 25°C, I _S = -4 A, V _{GS} = 0
t _{rr} Reverse Recovery Time	430			ns	T _J = 150°C, I _F = I _S , dI _F /dI _S = 100 A/ms

1 Pulse Test: Pulse Width 300msec, Duty Cycle 2%.

1 Pulse Test: Pulse Width 300msec, Duty Cycle 2%.

OM6001ST - OM6104ST

ABSOLUTE MAXIMUM RATINGS ($T_C = 25^\circ\text{C}$ unless otherwise noted)

Parameter	OM6001ST OM6101ST	OM6002ST OM6102ST	OM6003ST OM6103ST	OM6004ST OM6104ST	Units
V_{DS}	100	200	400	500	V
V_{DGR}	100	200	400	500	V
$I_D @ T_C = 25^\circ\text{C}$	± 14	± 9	± 5.5	± 4.5	A
$I_D @ T_C = 100^\circ\text{C}$	± 9	± 6	± 3.5	± 3	A
I_{DM}	± 56	± 36	± 22	± 18	A
$P_D @ T_C = 25^\circ\text{C}$	50	50	50	50	W
$P_D @ T_C = 100^\circ\text{C}$	20	20	20	20	W
Junction To Case	0.4	0.4	0.4	0.4	$W/^\circ\text{C}$
Junction To Ambient	.015	.015	.015	.015	$W/^\circ\text{C}$
T_J	Operating and				
T_{stg}	Storage Temperature Range				$^\circ\text{C}$
Lead Temperature	(1/16" from case for 10 secs.)	300	300	300	$^\circ\text{C}$

1 Pulse Test: Pulse width 300 μsec . Duty Cycle 2%.

2 Package Pin Limitations = 16 amps

THERMAL RESISTANCE (MAXIMUM) at $T_A = 25^\circ\text{C}$

R_{thJC}	Junction-to-Case	2.5	$^\circ\text{C/W}$
R_{thJA}	Junction-to-Ambient	65	$^\circ\text{C/W}$ Free Air Operation

POWER DERATING

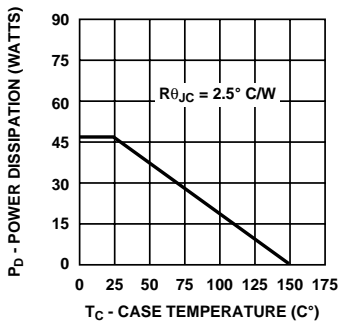

MECHANICAL OUTLINE WITH PIN CONNECTION

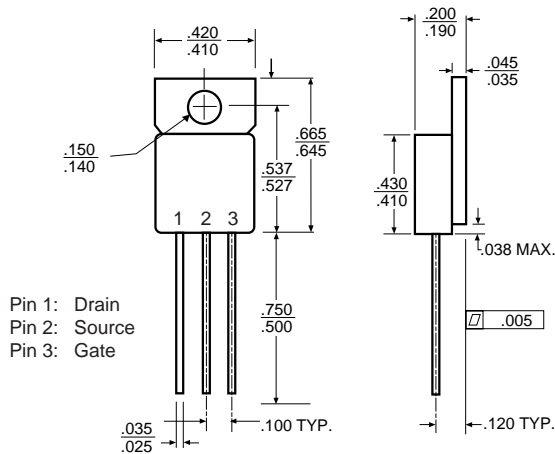

PACKAGE OPTIONS

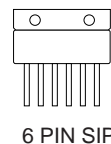
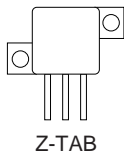
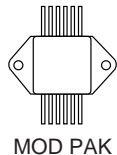

Note: MOSFETs are also available in Z-Tab, dual and quad pak styles. Duals and quads available in non-gate versions only. Please call the factory for more information.