

OP27A, OP27C, OP27E, OP27G OP37A, OP37C, OP37E, OP37G

LOW-NOISE HIGH-SPEED PRECISION OPERATIONAL AMPLIFIERS

SLOS100B – FEBRUARY 1989 – REVISED AUGUST 1994

- Direct Replacements for PMI and LTC OP27 and OP37 Series

Features of OP27A, OP27C, OP37A, and OP37C:

- **Maximum Equivalent Input Noise Voltage:**
3.8 nV/√Hz at 1 kHz
5.5 nV/√Hz at 10 kHz
- **Very Low Peak-to-Peak Noise Voltage at 0.1 Hz to 10 Hz . . . 80 nV Typ**
- **Low Input Offset Voltage . . . 25 μV Max**
- **High Voltage Amplification . . . 1 V/μV Min**

Feature of OP37 Series:

- **Minimum Slew Rate . . . 11 V/μs**

description

The OP27 and OP37 operational amplifiers combine outstanding noise performance with excellent precision and high-speed specifications. The wideband noise is only 3 nV/√Hz and with the 1/f noise corner at 2.7 Hz, low noise is maintained for all low-frequency applications.

The outstanding characteristics of the OP27 and OP37 make these devices excellent choices for low-noise amplifier applications requiring precision performance and reliability. Additionally, the OP37 is free of latch-up in high-gain, large-capacitive-feedback configurations.

The OP27 series is compensated for unity gain. The OP37 series is decompensated for increased bandwidth and slew rate and is stable down to a gain of 5.

The OP27A, OP27C, OP37A, and OP37C are characterized for operation over the full military temperature range of -55°C to 125°C. The OP27E, OP27G, OP37E, and OP37G are characterized for operation from -25°C to 85°C.

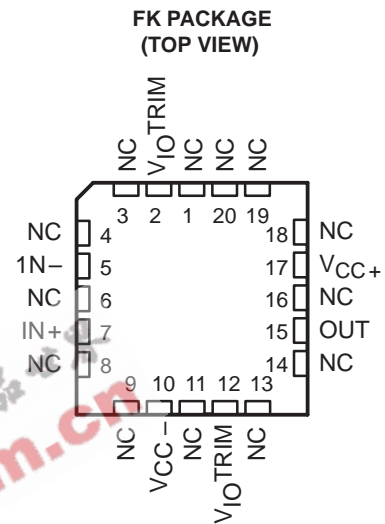
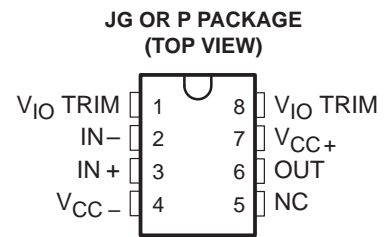

NC – No internal connection

symbol

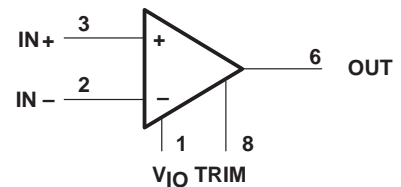

Pin numbers are for the JG and P packages.

AVAILABLE OPTIONS

T _A	V _{IO} max AT 25°C	STABLE GAIN	PACKAGE		
			CERAMIC DIP (JG)	CHIP CARRIER (FK)	PLASTIC DIP (P)
-25°C to 85°C	25 μV	1	—	—	OP27EP
		5	—	—	OP37EP
	100 μV	1	—	—	OP27GP
		5	—	—	OP37GP
-55°C to 125°C	25 μV	1	OP27AJG	OP27AFK	—
		5	OP37AJG	OP37AFK	—
	100 μV	1	OP27CJG	—	—
		5	OP37CJG	—	—

PRODUCTION DATA information is current as of publication date. Products conform to specifications per the terms of Texas Instruments standard warranty. Production processing does not necessarily include testing of all parameters.



OP27A, OP27C, OP27E, OP27G
 OP37A, OP37C, OP37E, OP37G
 LOW-NOISE HIGH-SPEED OPERATIONAL AMPLIFIER
 SLOS100B – FEBRUARY 1989 – REVISED AUGUST 1994

schematic

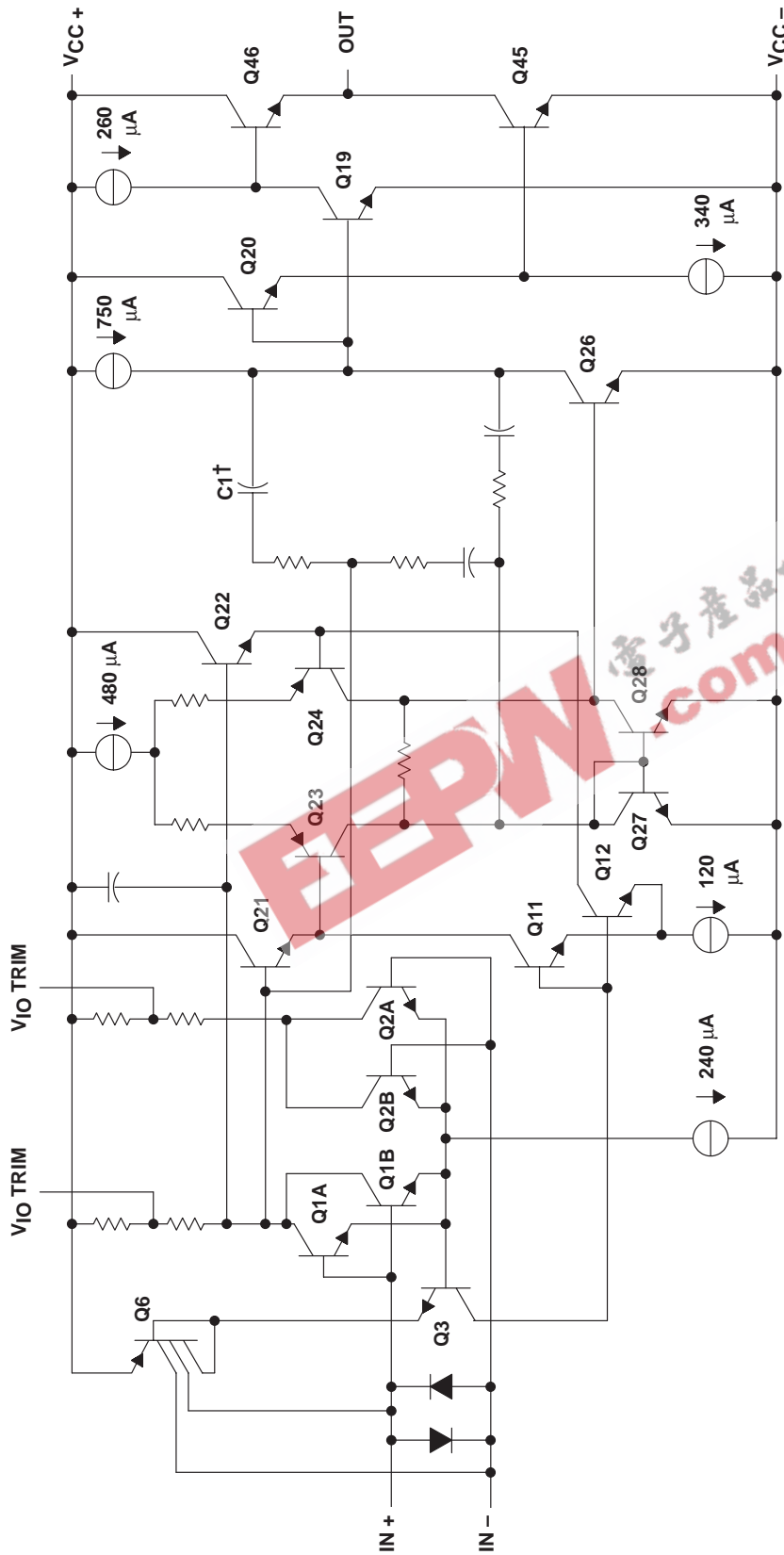

† C1 = 120 pF for OP27
 C1 = 15 pF for OP37

OP27A, OP27C, OP27E, OP27G
OP37A, OP37C, OP37E, OP37G

LOW-NOISE HIGH-SPEED PRECISION OPERATIONAL AMPLIFIERS

SLOS100B – FEBRUARY 1989 – REVISED AUGUST 1994

absolute maximum ratings over operating free-air temperature range (unless otherwise noted)

Supply voltage, V_{CC+} (see Note 1)	22 V
Supply voltage, V_{CC-} (see Note 1)	– 22 V
Input voltage, V_I	$V_{CC\pm}$
Duration of output short circuit	unlimited
Differential input current (see Note 2)	± 25 mA
Continuous power dissipation	See Dissipation Rating Table
Operating free-air temperature range: OP27A, OP27C, OP37A, OP37C	– 55°C to 125°C
OP27E, OP27G, OP37E, OP37G	– 25°C to 85°C
Storage temperature range	– 65°C to 150°C
Lead temperature 1,6 mm (1/16 inch) from case for 60 seconds: JG or FK package	300°C
Lead temperature 1,6 mm (1/16 inch) from case for 10 seconds : P package	260°C

- NOTES: 1. All voltage values are with respect to the midpoint between V_{CC+} and V_{CC-} unless otherwise noted.
2. The inputs are protected by back-to-back diodes. Current-limiting resistors are not used in order to achieve low noise. Excessive input current will flow if a differential input voltage in excess of approximately ± 0.7 V is applied between the inputs unless some limiting resistance is used.

DISSIPATION RATING TABLE

PACKAGE	$T_A \leq 25^\circ\text{C}$	DERATING FACTOR	$T_A = 85^\circ\text{C}$	$T_A = 125^\circ\text{C}$
	POWER RATING	ABOVE $T_A = 25^\circ\text{C}$	POWER RATING	POWER RATING
JG	1050 mW	8.4 mW/°C	546 mW	210 mW
FK	1375 mW	11.0 mW/°C	715 mW	275 mW
P	1000 mW	8.0 mW/°C	520 mW	N/A

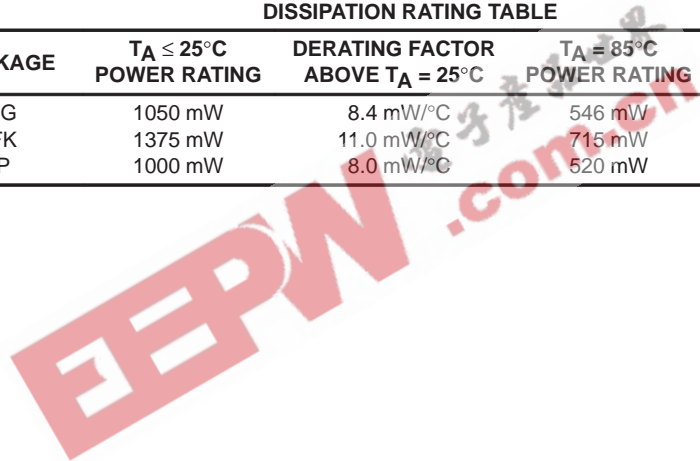

**OP27A, OP27C, OP27E, OP27G
OP37A, OP37C, OP37E, OP37G
LOW-NOISE HIGH-SPEED PRECISION OPERATIONAL AMPLIFIERS**

SLOS100B – FEBRUARY 1989 – REVISED AUGUST 1994

recommended operating conditions

		OP27A, OP37A			OP27C, OP37C			UNIT
		MIN	NOM	MAX	MIN	NOM	MAX	
Supply voltage, V_{CC+}		4	15	22	4	15	22	V
Supply voltage, V_{CC-}		-4	-15	-22	-4	-15	-22	V
Common-mode input voltage, V_{IC}	$V_{CC\pm} = \pm 15\text{ V}$, $T_A = 25^\circ\text{C}$	± 11			± 11			V
	$V_{CC\pm} = \pm 15\text{ V}$, $T_A = -55^\circ\text{C}$ to 125°C	± 10.3			± 10.2			
Operating free-air temperature, T_A		-55			125			$^\circ\text{C}$

electrical characteristics at specified free-air temperature, $V_{CC\pm} = \pm 15\text{ V}$ (unless otherwise noted)

PARAMETER		TEST CONDITIONS	T_A^\dagger	OP27A, OP37A			OP27C, OP37C			UNIT
				MIN	TYP	MAX	MIN	TYP	MAX	
V_{IO}	Input offset voltage	$V_O = 0$, $R_S = 50\ \Omega$, $V_{IC} = 0$ See Note 3	25 $^\circ\text{C}$	10		25	30		100	μV
			Full range	60			300			
α_{VIO}	Average temperature coefficient of input offset voltage		Full range	0.2		0.6	0.4		1.8	$\mu\text{V}/^\circ\text{C}$
	Long-term drift of input offset voltage	See Note 4		0.2		1	0.4		2	$\mu\text{V}/\text{mo}$
I_{IO}	Input offset current	$V_O = 0$, $V_{IC} = 0$	25 $^\circ\text{C}$	7		35	12		75	nA
			Full range	50			135			
I_{IB}	Input bias current	$V_O = 0$, $V_{IC} = 0$	25 $^\circ\text{C}$	± 10		± 40	± 15		± 80	nA
			Full range	± 60			± 150			
V_{ICR}	Common-mode input voltage range		25 $^\circ\text{C}$	11 to -11			11 to -11			V
			Full range	10.3 to -10.3			10.5 to -10.5			
V_{OM}	Peak output voltage swing	$R_L \geq 2\ \text{k}\Omega$		± 12		± 13.8	± 11.5		± 13.5	V
				± 10		± 11.5	± 10		± 11.5	
			Full range	± 11.5			10.5			
A_{VD}	Large-signal differential voltage amplification	$R_L \geq 2\ \text{k}\Omega$, $V_O = \pm 10\ \text{V}$		1000		1800	700		1500	V/mV
				800		1500	1500			
			$R_L \geq 0.6\ \text{k}\Omega$, $V_O = \pm 1\ \text{V}$, $V_{CC\pm} = \pm 4\ \text{V}$	250		700	200		500	
		Full range	600			300				
$r_{i(CM)}$	Common-mode input resistance			3			2		$\text{G}\Omega$	
r_o	Output resistance	$V_O = 0$, $I_O = 0$	25 $^\circ\text{C}$	70			70		Ω	
CMRR	Common-mode rejection ratio	$V_{IC} = \pm 11\ \text{V}$	25 $^\circ\text{C}$	114		126	100		120	dB
			Full range	110			94			
kSVR	Supply voltage rejection ratio	$V_{CC\pm} = \pm 4\ \text{V}$ to $\pm 18\ \text{V}$	25 $^\circ\text{C}$	100		120	94		118	dB
			Full range	96			86			

† Full range is -55°C to 125°C .

- NOTES: 3. Input offset voltage measurements are performed by automatic test equipment approximately 0.5 seconds after applying power.
4. Long-term drift of input offset voltage refers to the average trend line of offset voltage versus time over extended periods after the first 30 days of operation. Excluding the initial hour of operation, changes in V_{IO} during the first 30 days are typically $2.5\ \mu\text{V}$ (see Figure 3).



OP27A, OP27C, OP27E, OP27G
OP37A, OP37C, OP37E, OP37G
LOW-NOISE HIGH-SPEED PRECISION OPERATIONAL AMPLIFIERS
SLOS100B – FEBRUARY 1989 – REVISED AUGUST 1994

recommended operating conditions

		MIN	NOM	MAX	UNIT
Supply voltage, V_{CC+}		4	15	22	V
Supply voltage, V_{CC-}		-4	-15	-22	V
Common-mode input voltage, V_{IC}	$V_{CC\pm} = \pm 15$ V, $T_A = 25^\circ\text{C}$	± 11			V
	$V_{CC\pm} = \pm 15$ V, $T_A = -55^\circ\text{C}$ to 125°C	± 10.5			
Operating free-air temperature, T_A		-25		85	$^\circ\text{C}$

electrical characteristics at specified free-air temperature, $V_{CC\pm} = \pm 15$ V (unless otherwise noted)

PARAMETER	TEST CONDITIONS	T_A^\dagger	OP27E, OP37E			OP27G, OP37G			UNIT
			MIN	TYP	MAX	MIN	TYP	MAX	
V_{IO} Input offset voltage	$V_O = 0$, $V_{IC} = 0$ $R_S = 50 \Omega$, See Note 3	25°C		10	25		30	100	μV
		Full range			60			220	
αV_{IO} Average temperature coefficient of input offset voltage		Full range		0.2	0.6		0.4	1.8	$\mu\text{V}/^\circ\text{C}$
Long-term drift of input offset voltage	See Note 4			0.2	1		0.4	2	$\mu\text{V}/\text{mo}$
I_{IO} Input offset current	$V_O = 0$, $V_{IC} = 0$	25°C		7	35		12	75	nA
		Full range			50			135	
I_{IB} Input bias current	$V_O = 0$, $V_{IC} = 0$	25°C		± 10	± 40		± 15	± 80	nA
		Full range			± 60			± 150	
V_{ICR} Common-mode input voltage range		25°C		11 to -11			11 to -11		V
		Full range		10.3 to -10.3			10.5 to -10.5		
V_{OM} Peak output voltage swing	$R_L \geq 2 \text{ k}\Omega$			± 12	± 13.8		± 11.5	± 13.5	V
	$R_L \geq 0.6 \text{ k}\Omega$			± 10	± 11.5		± 10	± 11.5	
	$R_L \geq 2 \text{ k}\Omega$	Full range			± 11.5		10.5		
A_{VD} Large-signal differential voltage amplification	$R_L \geq 2 \text{ k}\Omega$, $V_O = \pm 10$ V			1000	1800		700	1500	V/mV
	$R_L \geq 1 \text{ k}\Omega$, $V_O = \pm 10$ V			800	1500			1500	
	$R_L \geq 0.6 \text{ k}\Omega$, $V_O = \pm 1$ V, $V_{CC\pm} = \pm 4$ V			250	700		200	500	
	$R_L \geq 2 \text{ k}\Omega$, $V_O = \pm 10$ V	Full range			600		450		
$r_{i(CM)}$ Common-mode input resistance				3			2	$\text{G}\Omega$	
r_o Output resistance	$V_O = 0$, $I_O = 0$	25°C		70			70	Ω	
CMRR Common-mode rejection ratio	$V_{IC} = \pm 11$ V	25°C		114	126		100	120	dB
	$V_{IC} = \pm 10$ V	Full range		110			96		
k_{SVR} Supply voltage rejection ratio	$V_{CC\pm} = \pm 4$ V to ± 18 V	25°C		100	120		94	118	dB
	$V_{CC\pm} = \pm 4.5$ V to ± 18 V	Full range		96			90		

† Full range is -25°C to 85°C .

- NOTES: 3. Input offset voltage measurements are performed by automatic test equipment approximately 0.5 seconds after applying power.
4. Long-term drift of input offset voltage refers to the average trend line of offset voltage versus time over extended periods after the first 30 days of operation. Excluding the initial hour of operation, changes in V_{IO} during the first 30 days are typically $2.5 \mu\text{V}$ (see Figure 3).



**OP27A, OP27C, OP27E, OP27G
OP37A, OP37C, OP37E, OP37G
LOW-NOISE HIGH-SPEED PRECISION OPERATIONAL AMPLIFIERS**

SLOS100B – FEBRUARY 1989 – REVISED AUGUST 1994

OP27 operating characteristics over operating free-air temperature range, $V_{CC\pm} = \pm 15\text{ V}$

PARAMETER		TEST CONDITIONS	OP27A, OP27E			OP27C, OP27G			UNIT
			MIN	TYP	MAX	MIN	TYP	MAX	
SR	Slew rate	$A_{VD} \geq 1$, $R_L \geq 2\text{ k}\Omega$	1.7	2.8		1.7	2.8		V/ μs
$V_{N(PP)}$	Peak-to-peak equivalent input noise voltage	$f = 0.1\text{ Hz to }10\text{ Hz}$, $R_S = 20\ \Omega$, See Figure 34		0.08	0.18		0.09	0.25	μV
V_n	Equivalent input noise voltage	$f = 10\text{ Hz}$, $R_S = 20\ \Omega$		3.5	5.5		3.8	8	nV/ $\sqrt{\text{Hz}}$
		$f = 30\text{ Hz}$, $R_S = 20\ \Omega$		3.1	4.5		3.3	5.6	
		$f = 1\text{ kHz}$, $R_S = 20\ \Omega$		3	3.8		3.2	4.5	
I_n	Equivalent input noise current	$f = 10\text{ Hz}$, See Figure 35		1.5	4		1.5		pA/ $\sqrt{\text{Hz}}$
		$f = 30\text{ Hz}$, See Figure 35		1	2.3		1		
		$f = 1\text{ kHz}$, See Figure 35		0.4	0.6		0.4	0.6	
Gain-bandwidth product		$f = 100\text{ kHz}$	5	8		5	8		MHz

OP37 operating characteristics over operating free-air temperature range, $V_{CC\pm} = \pm 15\text{ V}$

PARAMETER		TEST CONDITIONS	OP37A, OP37E			OP37C, OP37G			UNIT
			MIN	TYP	MAX	MIN	TYP	MAX	
SR	Slew rate	$A_{VD} \geq 5$, $R_L \geq 2\text{ k}\Omega$	11	17		11	17		V/ μs
$V_{N(PP)}$	Peak-to-peak equivalent input noise voltage	$f = 0.1\text{ Hz to }10\text{ Hz}$, $R_S = 20\ \Omega$, See Figure 34		0.08	0.18		0.09	0.25	μV
V_n	Equivalent input noise voltage	$f = 10\text{ Hz}$, $R_S = 20\ \Omega$		3.5	5.5		3.8	8	nV/ $\sqrt{\text{Hz}}$
		$f = 30\text{ Hz}$, $R_S = 20\ \Omega$		3.1	4.5		3.3	5.6	
		$f = 1\text{ kHz}$, $R_S = 20\ \Omega$		3	3.8		3.2	4.5	
I_n	Equivalent input noise current	$f = 10\text{ Hz}$, See Figure 35		1.5	4		1.5		pA/ $\sqrt{\text{Hz}}$
		$f = 30\text{ Hz}$, See Figure 35		1	2.3		1		
		$f = 1\text{ kHz}$, See Figure 35		0.4	0.6		0.4	0.6	
Gain-bandwidth product		$f = 10\text{ kHz}$	45	63		45	63		MHz
		$A_V \geq 5$, $f = 1\text{ MHz}$		40			40		

OP27A, OP27C, OP27E, OP27G
OP37A, OP37C, OP37E, OP37G

LOW-NOISE HIGH-SPEED PRECISION OPERATIONAL AMPLIFIERS

SLOS100B – FEBRUARY 1989 – REVISED AUGUST 1994

TYPICAL CHARACTERISTICS

Table of Graphs

			FIGURE
V_{IO}	Input offset voltage	vs Temperature	1
ΔV_{IO}	Change in input offset voltage	vs Time after power on	2
		vs Time (long-term drift)	3
I_{IO}	Input offset current	vs Temperature	4
I_{IB}	Input bias current	vs Temperature	5
V_{ICR}	Common-mode input voltage range	vs Supply voltage	6
V_{OM}	Maximum peak output voltage	vs Load resistance	7
$V_{O(PP)}$	Maximum peak-to-peak output voltage	vs Frequency	8, 9
A_{VD}	Differential voltage amplification	vs Supply voltage	10
		vs Load resistance	11
		vs Frequency	12, 13, 14
CMRR	Common-mode rejection ratio	vs Frequency	15
k_{SVR}	Supply voltage rejection ratio	vs Frequency	16
SR	Slew rate	vs Temperature	17
		vs Supply voltage	18
		vs Load resistance	19
ϕ_m	Phase margin	vs Temperature	20, 21
ϕ	Phase shift	vs Frequency	12, 13
V_n	Equivalent input noise voltage	vs Bandwidth	22
		vs Source resistance	23
		vs Supply voltage	24
		vs Temperature	25
		vs Frequency	26
I_n	Equivalent input noise current	vs Frequency	27
	Gain-bandwidth product	vs Temperature	20, 21
I_{OS}	Short-circuit output current	vs Time	28
I_{CC}	Supply current	vs Supply voltage	29
	Pulse response	Small signal	30, 32
		Large signal	31, 33

OP27A, OP27C, OP27E, OP27G
 OP37A, OP37C, OP37E, OP37G
 LOW-NOISE HIGH-SPEED PRECISION OPERATIONAL AMPLIFIERS
 SLOS100B – FEBRUARY 1989 – REVISED AUGUST 1994

TYPICAL CHARACTERISTICS†

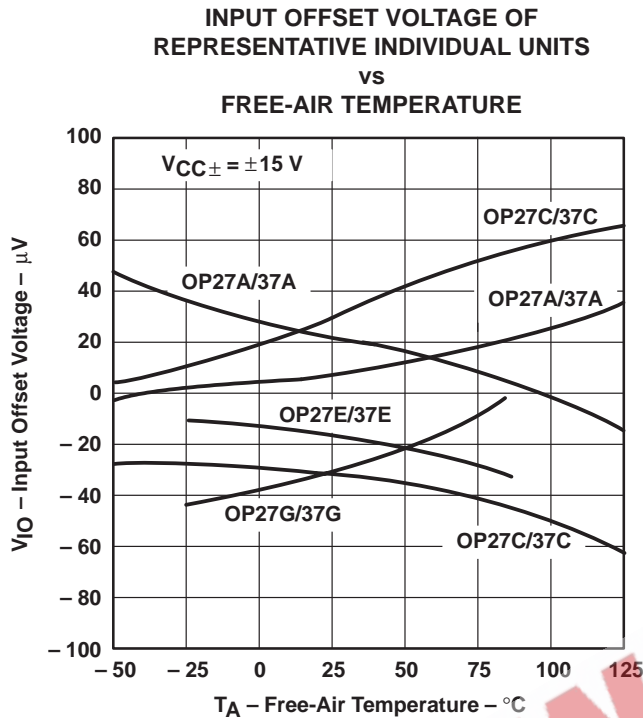

Figure 1

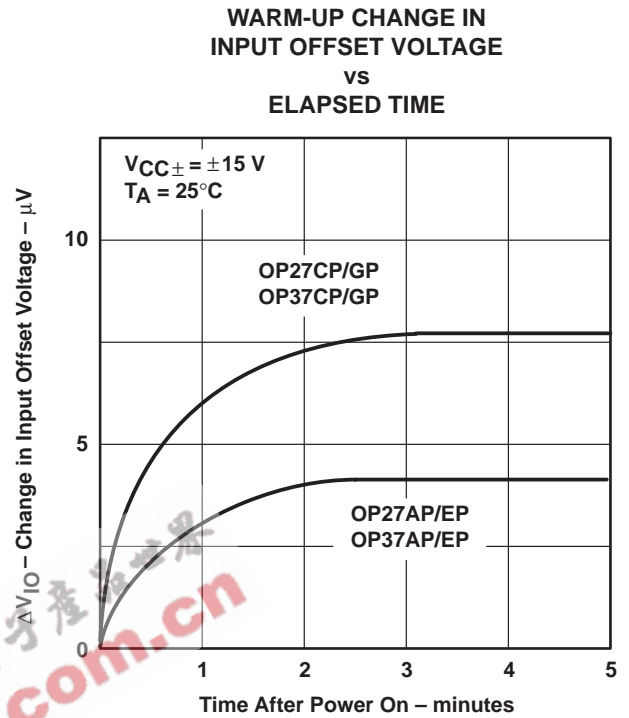

Figure 2

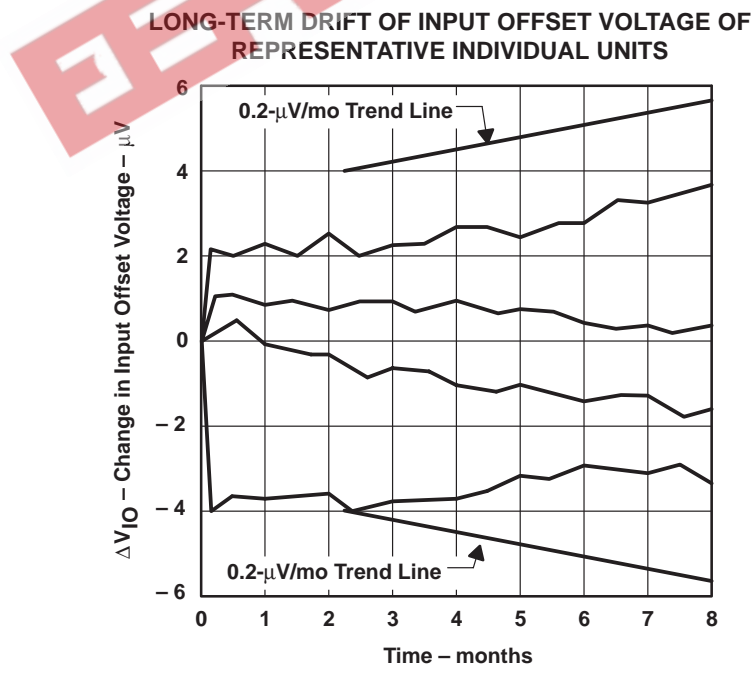

Figure 3

† Data for temperatures below -25°C and above 85°C are applicable to the OP27A, OP27C, OP37A, and OP37C only.

OP27A, OP27C, OP27E, OP27G
OP37A, OP37C, OP37E, OP37G
SLOS100B – FEBRUARY 1989 – REVISED AUGUST 1994

TYPICAL CHARACTERISTICS†

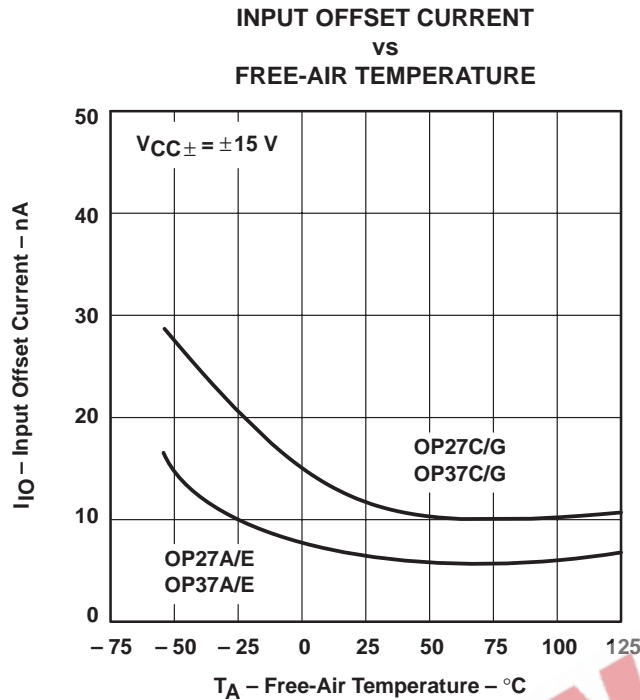

Figure 4

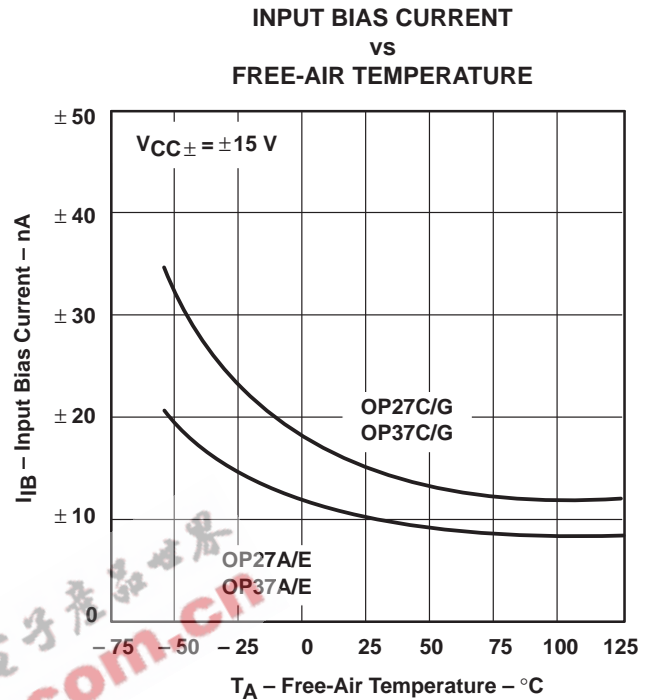

Figure 5

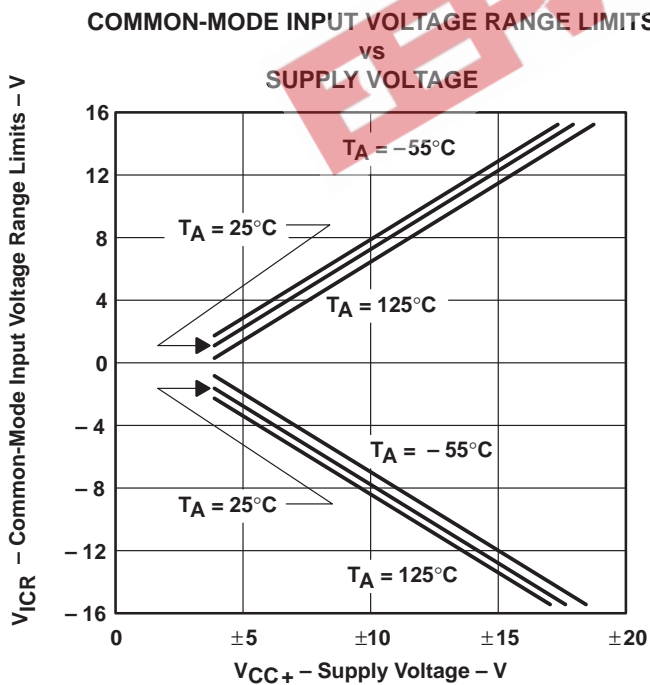

Figure 6

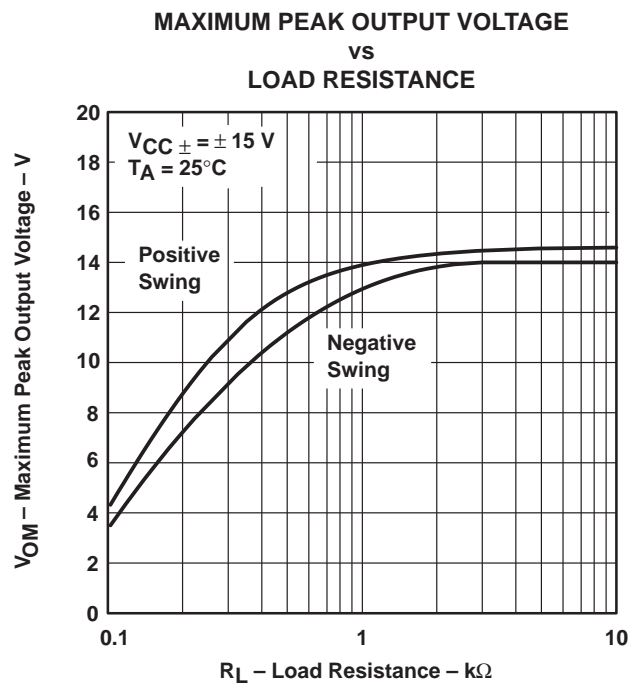

Figure 7

† Data for temperatures below -25°C and above 85°C are applicable to the OP27A, OP27C, OP37A, and OP37C only.

OP27A, OP27C, OP27E, OP27G
 OP37A, OP37C, OP37E, OP37G
 LOW-NOISE HIGH-SPEED PRECISION OPERATIONAL AMPLIFIERS
 SLOS100B – FEBRUARY 1989 – REVISED AUGUST 1994

TYPICAL CHARACTERISTICS

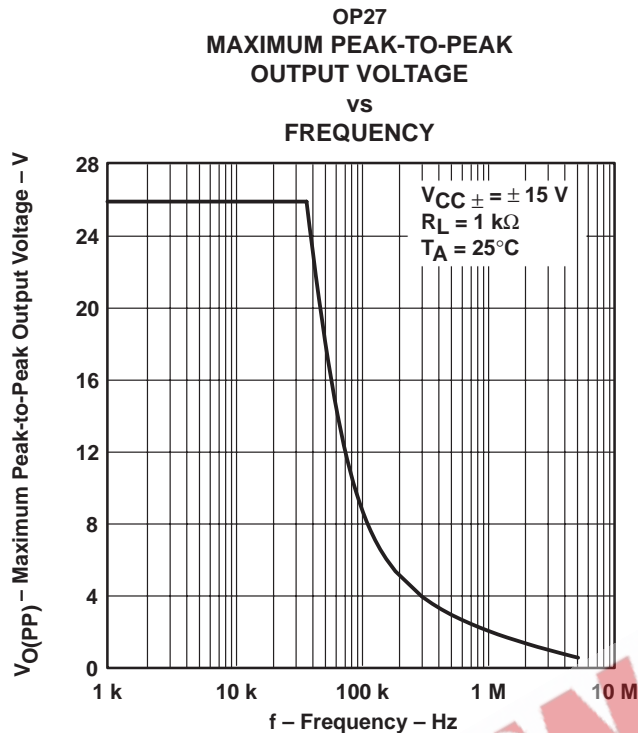

Figure 8

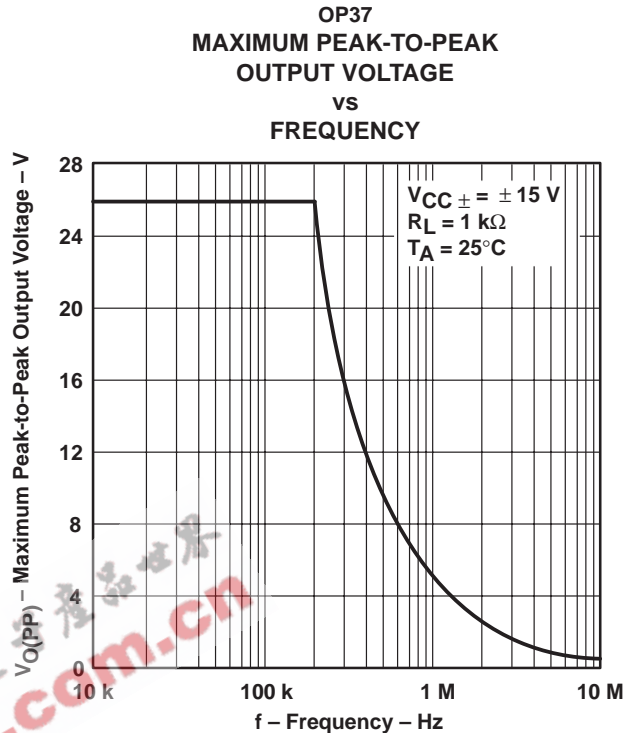

Figure 9

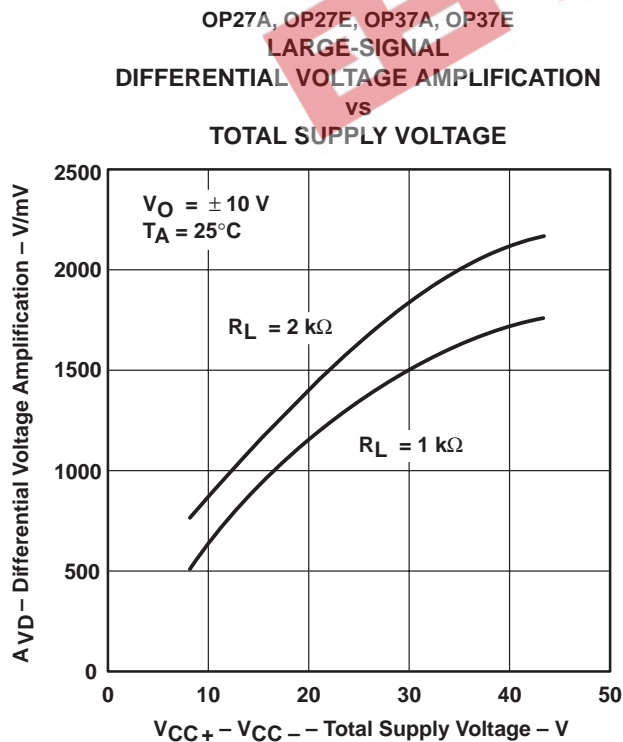

Figure 10

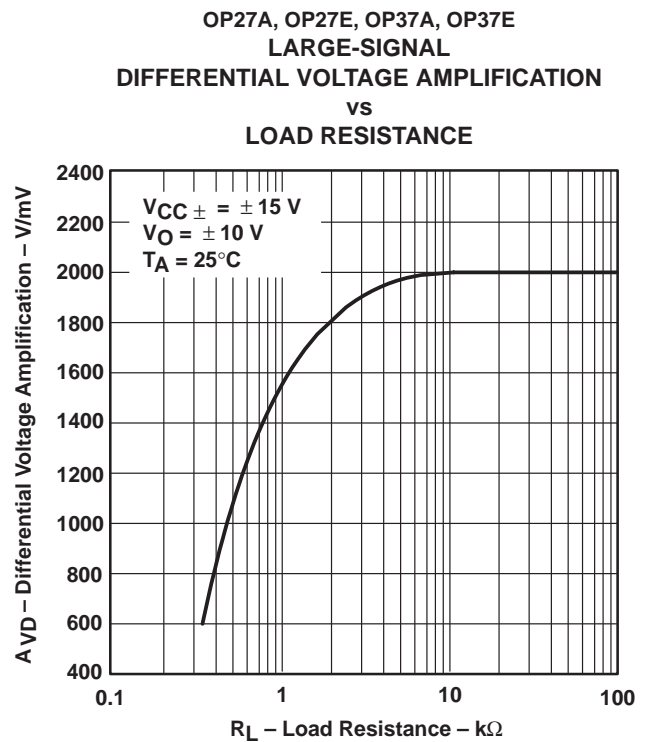

Figure 11

OP27A, OP27C, OP27E, OP27G
OP37A, OP37C, OP37E, OP37G
LOW-NOISE HIGH-SPEED PRECISION OPERATIONAL AMPLIFIERS
SLOS100B – FEBRUARY 1989 – REVISED AUGUST 1994

TYPICAL CHARACTERISTICS

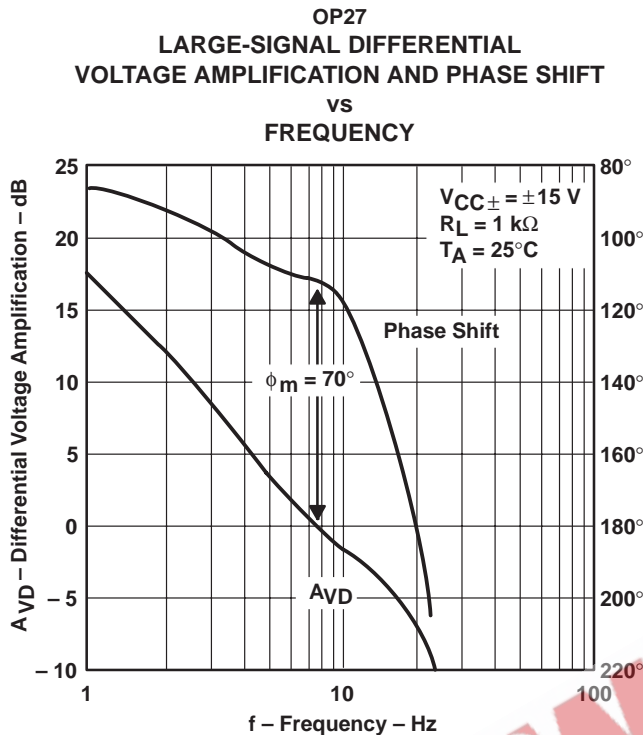

Figure 12

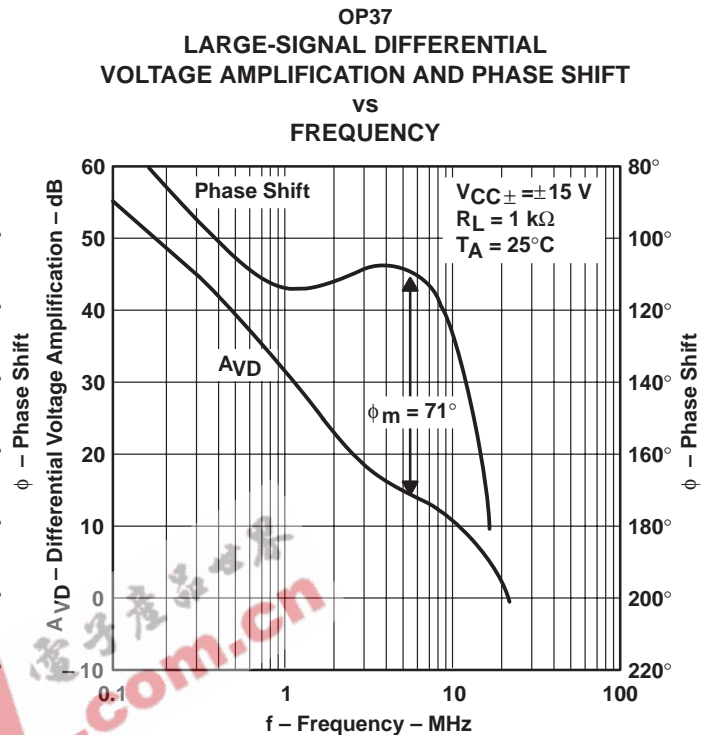

Figure 13

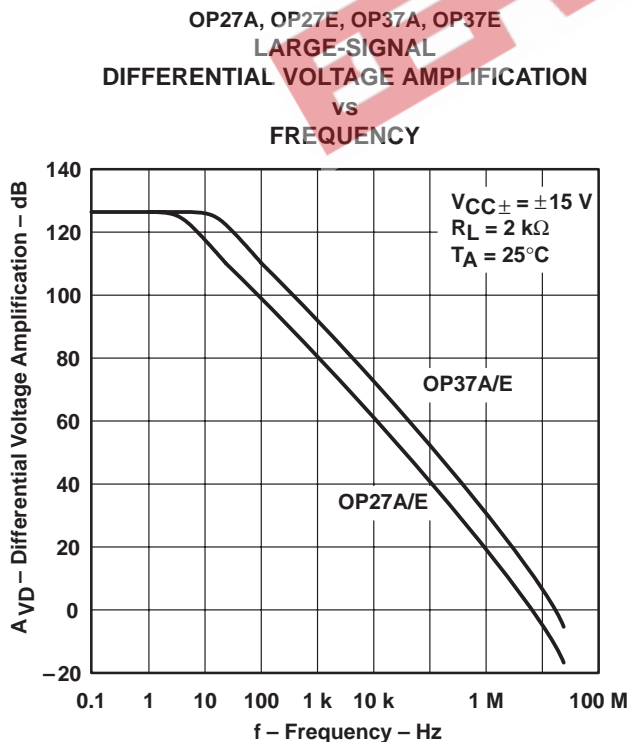

Figure 14

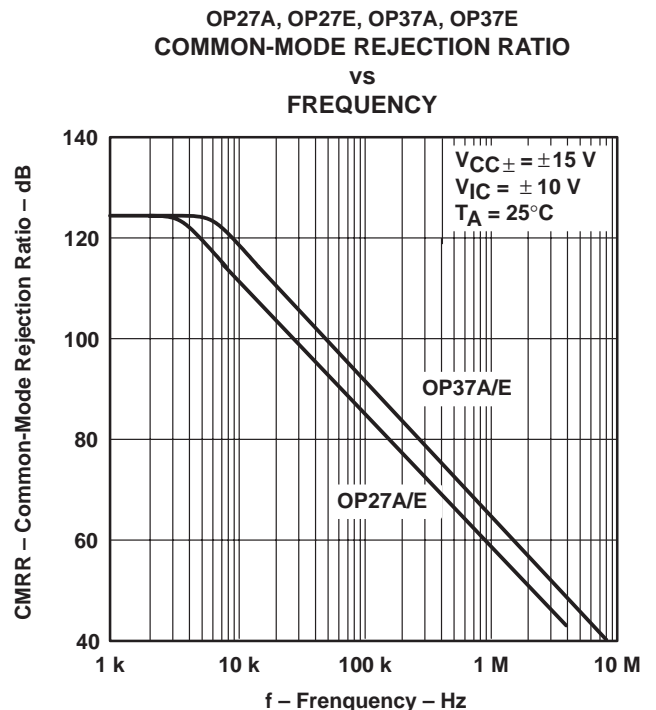

Figure 15

OP27A, OP27C, OP27E, OP27G
 OP37A, OP37C, OP37E, OP37G
 LOW-NOISE HIGH-SPEED PRECISION OPERATIONAL AMPLIFIERS
 SLOS100B – FEBRUARY 1989 – REVISED AUGUST 1994

TYPICAL CHARACTERISTICS†

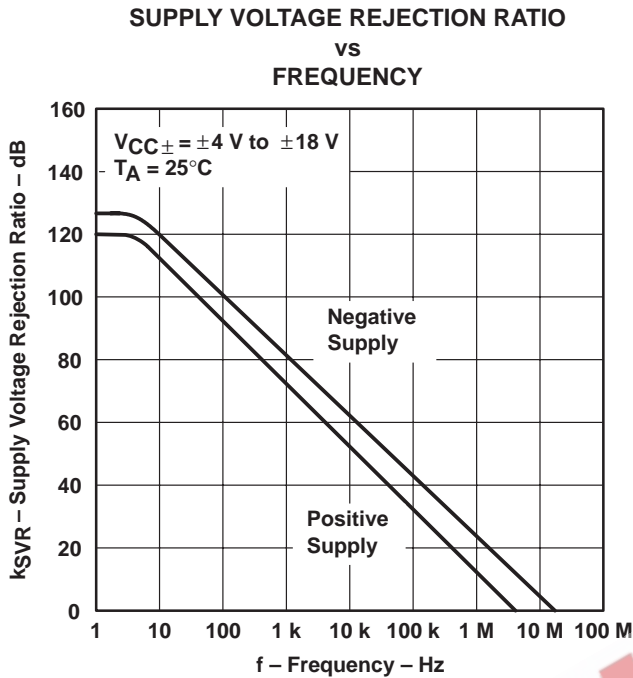

Figure 16

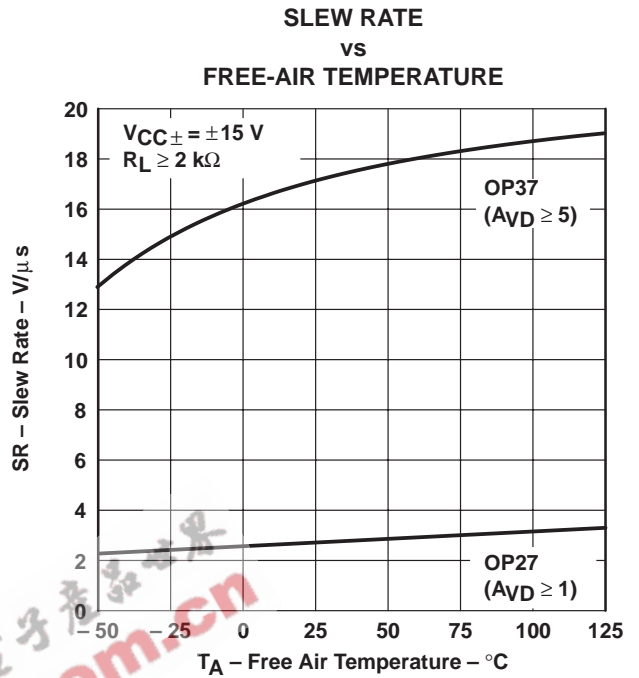

Figure 17

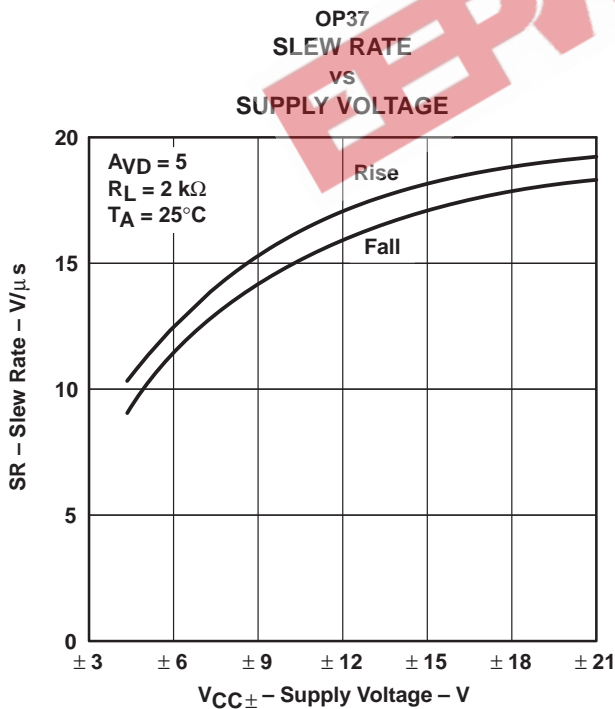

Figure 18

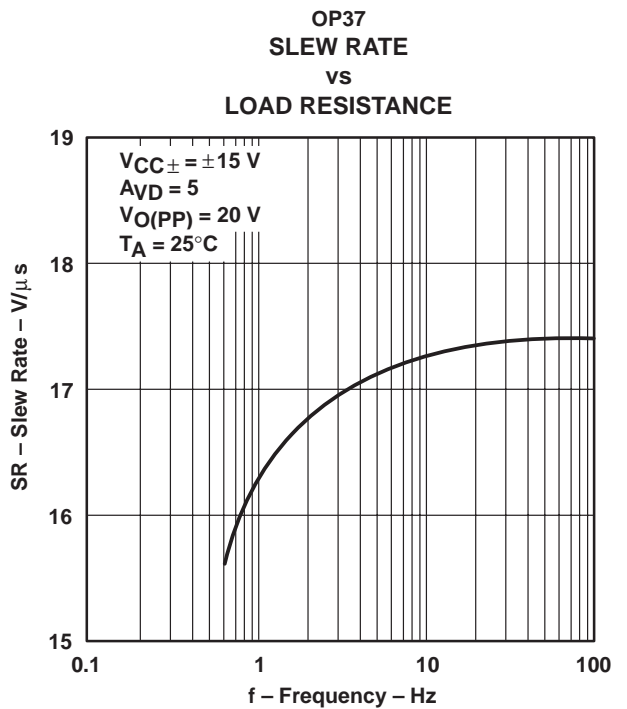

Figure 19

† Data for temperatures below -25°C and above 85°C are applicable to the OP27A, OP27C, OP37A, and OP37C only.

OP27A, OP27C, OP27E, OP27G
OP37A, OP37C, OP37E, OP37G
LOW-NOISE HIGH-SPEED PRECISION OPERATIONAL AMPLIFIERS
SLOS100B – FEBRUARY 1989 – REVISED AUGUST 1994

TYPICAL CHARACTERISTICS†

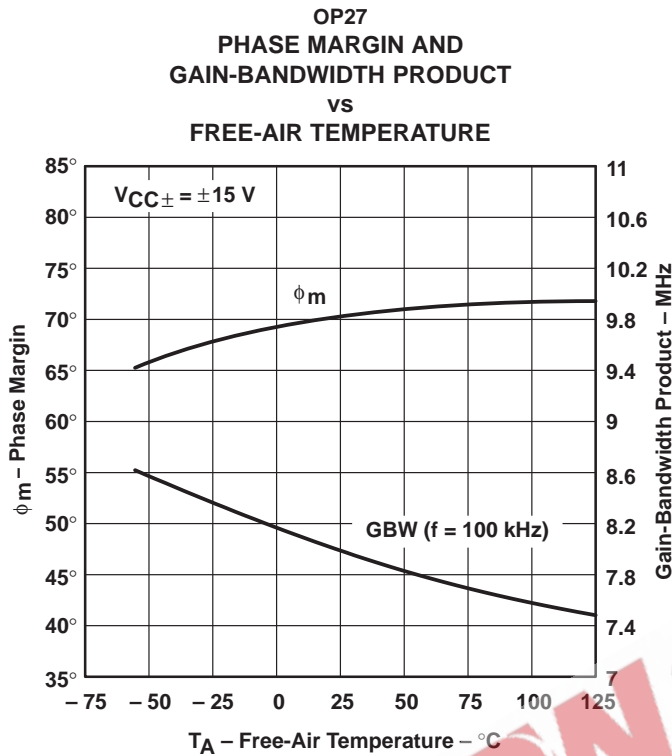

Figure 20

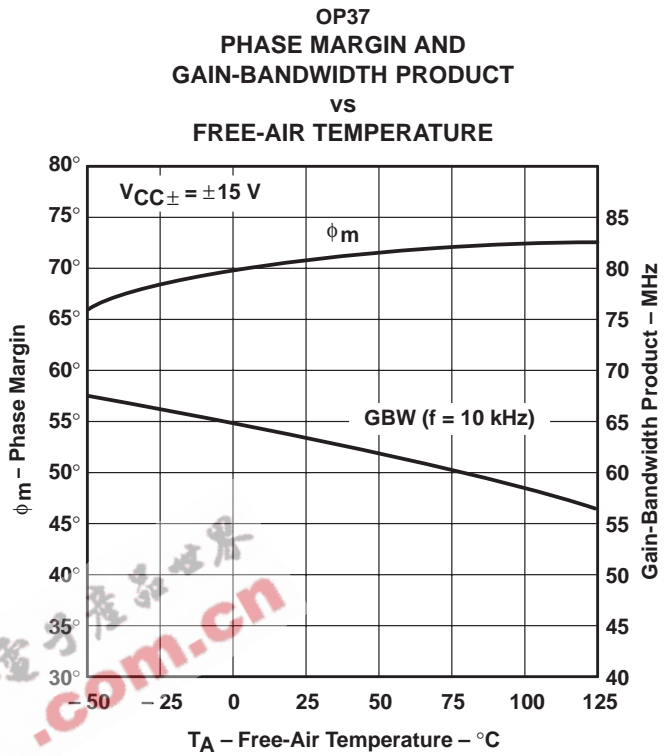

Figure 21

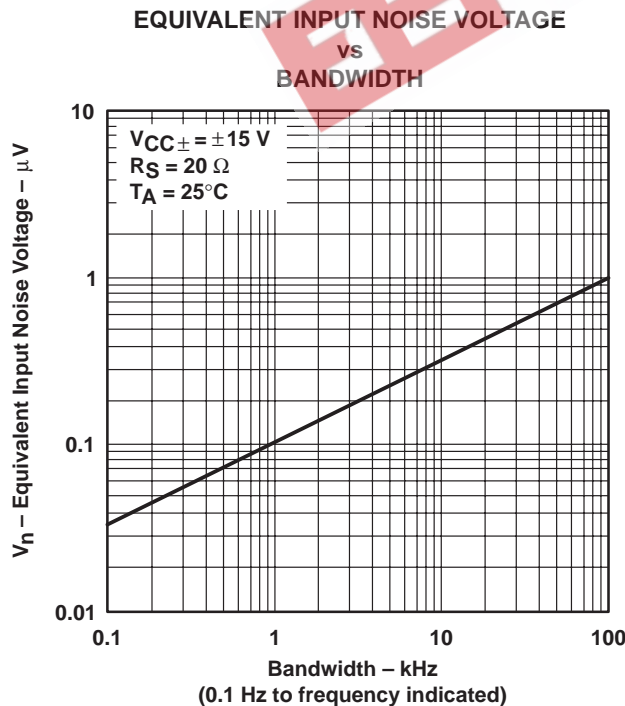

Figure 22

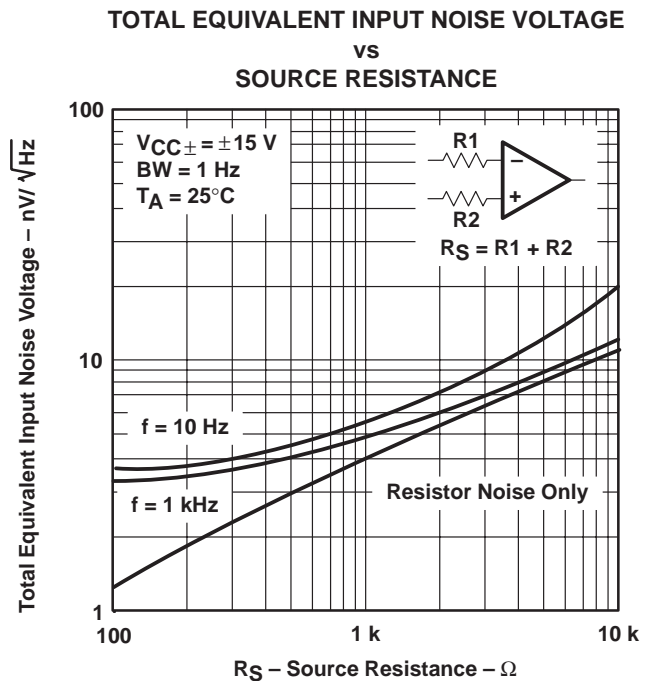

Figure 23

† Data for temperatures below -25°C and above 85°C are applicable to the OP27A, OP27C, OP37A, and OP37C only.

OP27A, OP27C, OP27E, OP27G
 OP37A, OP37C, OP37E, OP37G
 LOW-NOISE HIGH-SPEED PRECISION OPERATIONAL AMPLIFIERS
 SLOS100B – FEBRUARY 1989 – REVISED AUGUST 1994

TYPICAL CHARACTERISTICS†

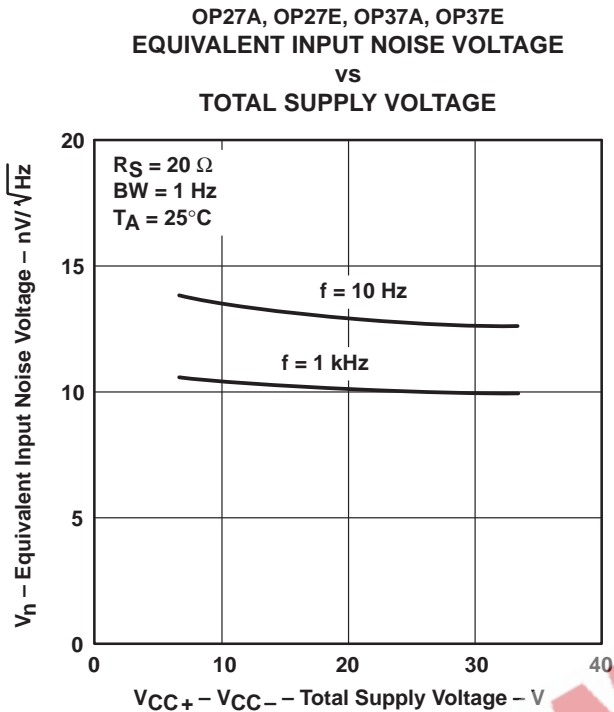

Figure 24

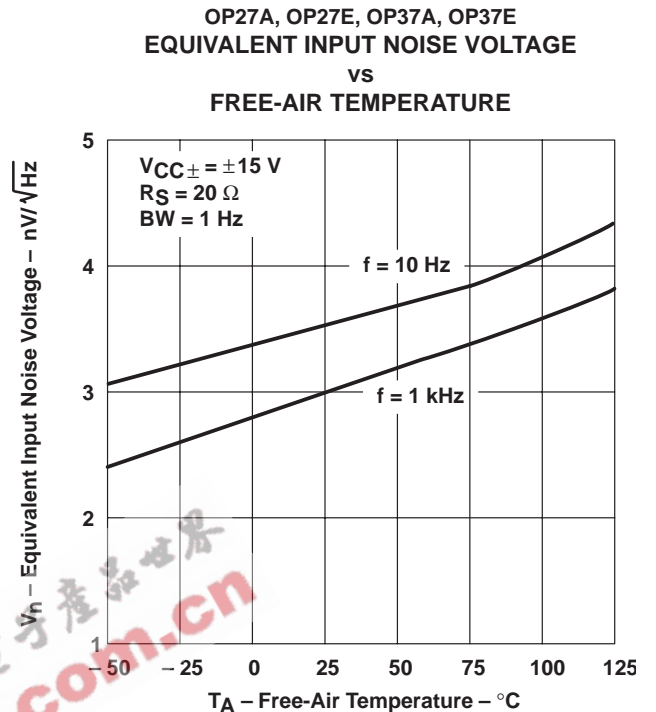

Figure 25

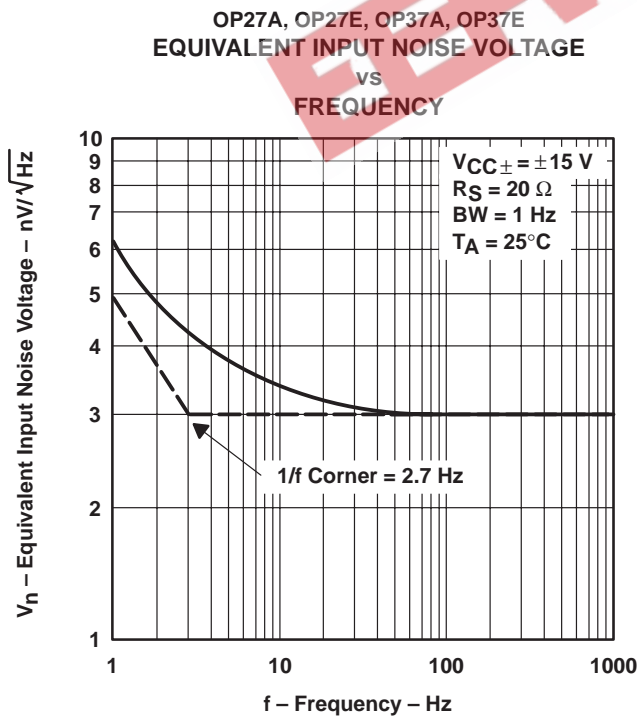

Figure 26

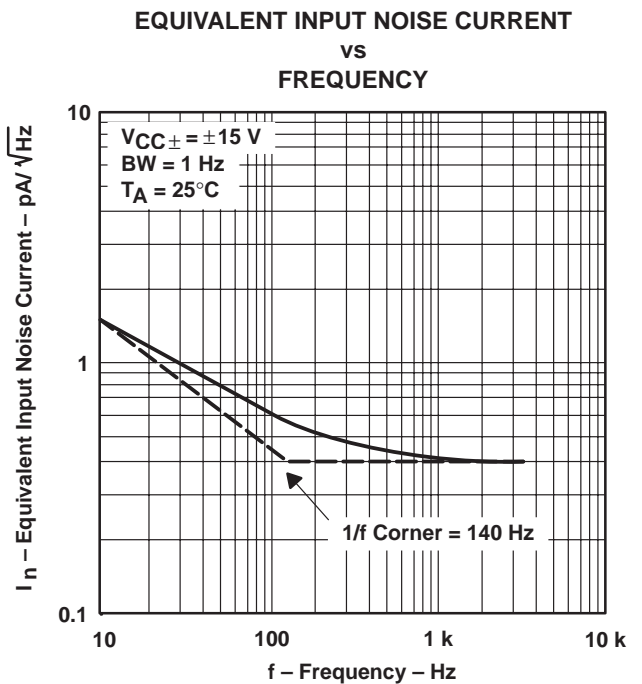

Figure 27

† Data for temperatures below $-25^\circ C$ and above $85^\circ C$ are applicable to the OP27A, OP27C, OP37A, and OP37C only.

OP27A, OP27C, OP27E, OP27G
OP37A, OP37C, OP37E, OP37G
LOW-NOISE HIGH-SPEED PRECISION OPERATIONAL AMPLIFIERS
SLOS100B – FEBRUARY 1989 – REVISED AUGUST 1994

TYPICAL CHARACTERISTICS†

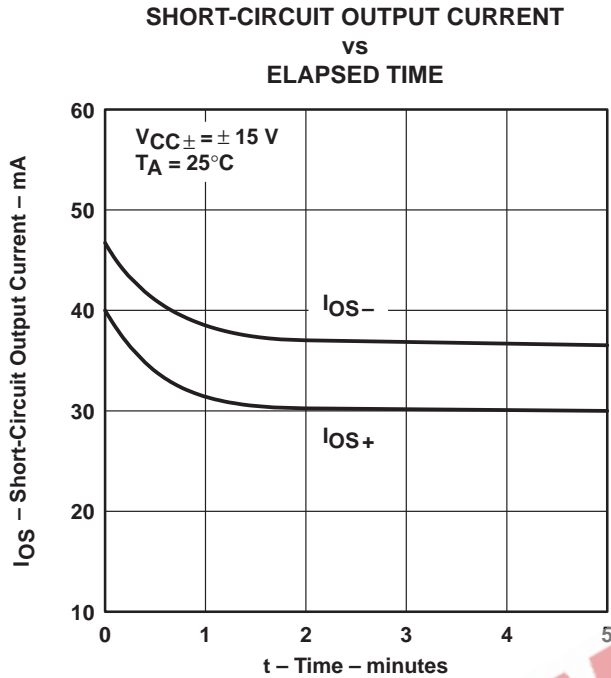

Figure 28

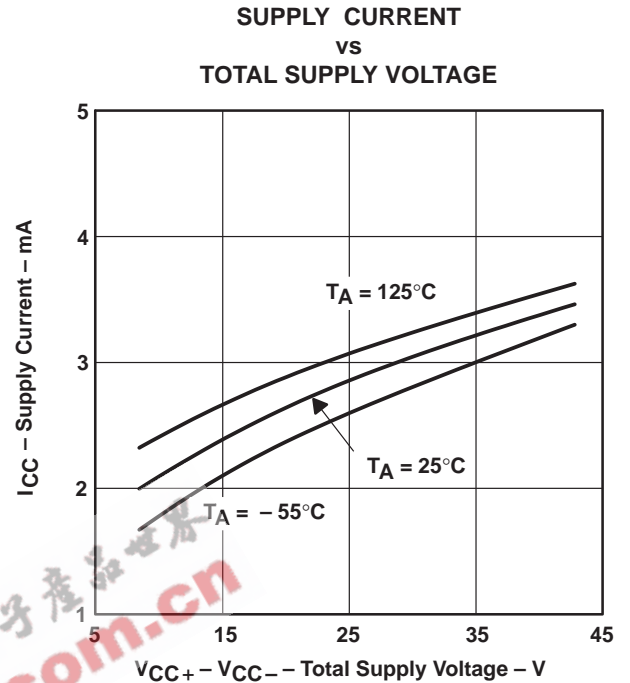

Figure 29

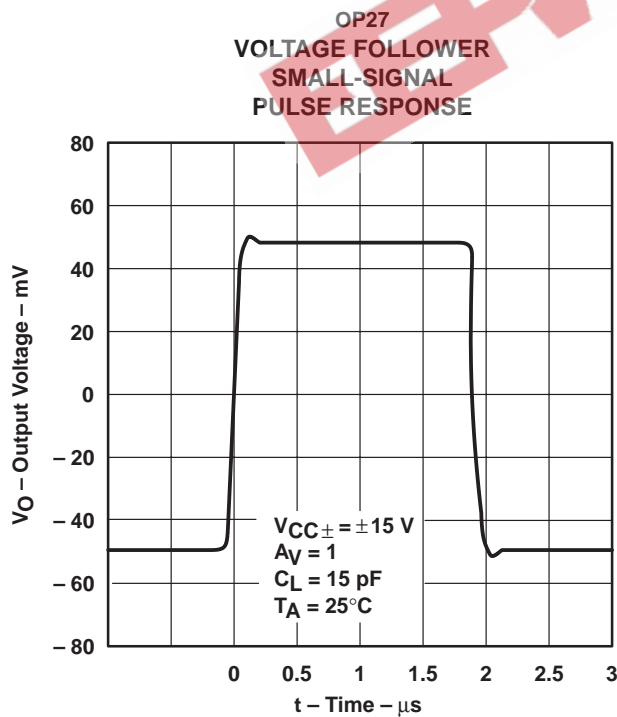

Figure 30

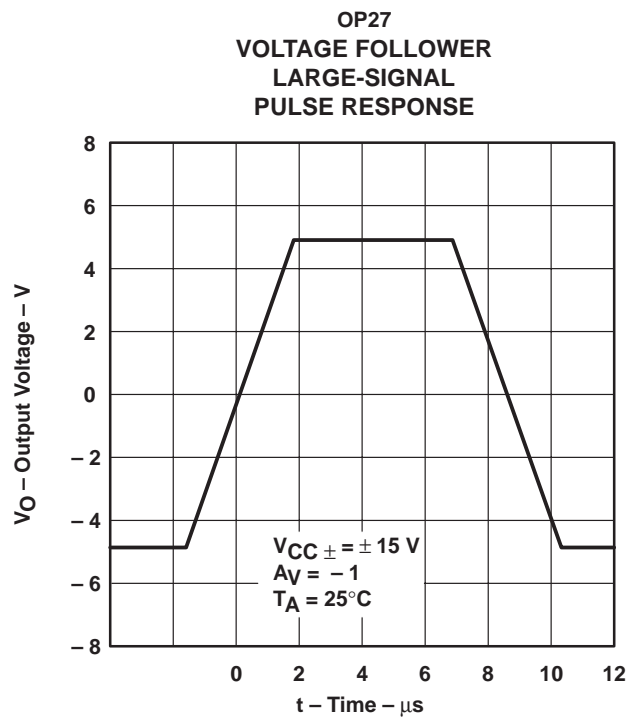

Figure 31

† Data for temperatures below -25°C and above 85°C are applicable to the OP27A, OP27C, OP37A, and OP37C only.

OP27A, OP27C, OP27E, OP27G
 OP37A, OP37C, OP37E, OP37G
 LOW-NOISE HIGH-SPEED PRECISION OPERATIONAL AMPLIFIERS
 SLOS100B – FEBRUARY 1989 – REVISED AUGUST 1994

TYPICAL CHARACTERISTICS

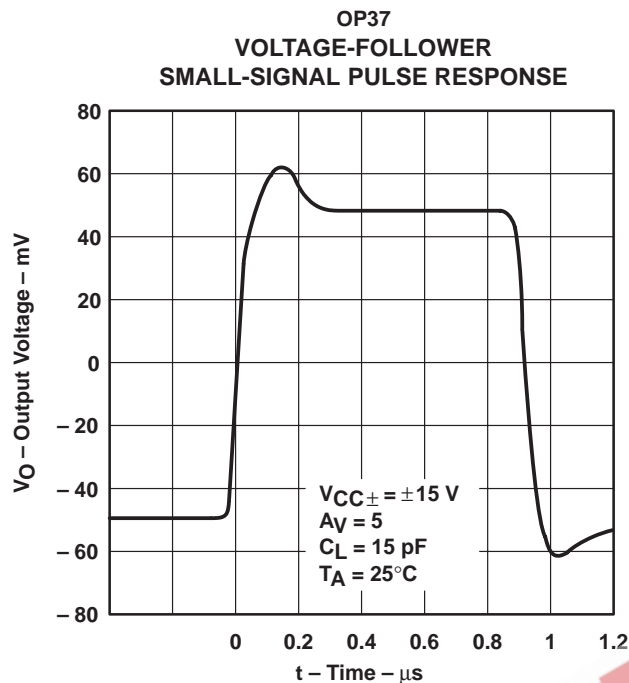

Figure 32

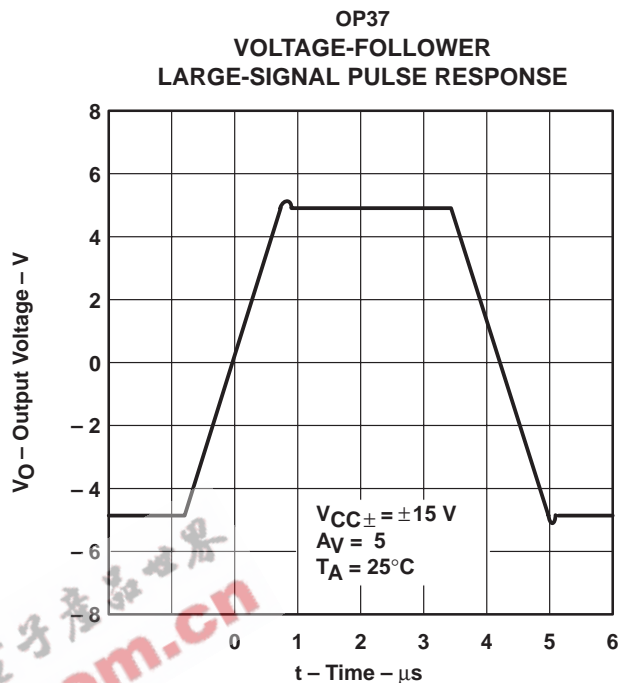

Figure 33

APPLICATION INFORMATION

general

The OP27 and OP37 series devices can be inserted directly onto OP07, OP05, μ A725, and SE5534 sockets with or without removing external compensation or nulling components. In addition, the OP27 and OP37 can be fitted to μ A741 sockets by removing or modifying external nulling components.

noise testing

Figure 34 shows a test circuit for 0.1-Hz to 10-Hz peak-to-peak noise measurement of the OP27 and OP37. The frequency response of this noise tester indicates that the 0.1-Hz corner is defined by only one zero. Because the time limit acts as an additional zero to eliminate noise contributions from the frequency band below 0.1 Hz, the test time to measure 0.1-Hz to 10-Hz noise should not exceed 10 seconds.

Measuring the typical 80-nV peak-to-peak noise performance of the OP27 and OP37 requires the following special test precautions:

1. The device should be warmed up for at least five minutes. As the operational amplifier warms up, the offset voltage typically changes 4 μ V due to the chip temperature increasing from 10°C to 20°C starting from the moment the power supplies are turned on. In the 10-s measurement interval, these temperature-induced effects can easily exceed tens of nanovolts.
2. For similar reasons, the device should be well shielded from air currents to eliminate the possibility of thermoelectric effects in excess of a few nanovolts, which would invalidate the measurements.
3. Sudden motion in the vicinity of the device should be avoided, as it produces a feedthrough effect that increases observed noise.



APPLICATION INFORMATION

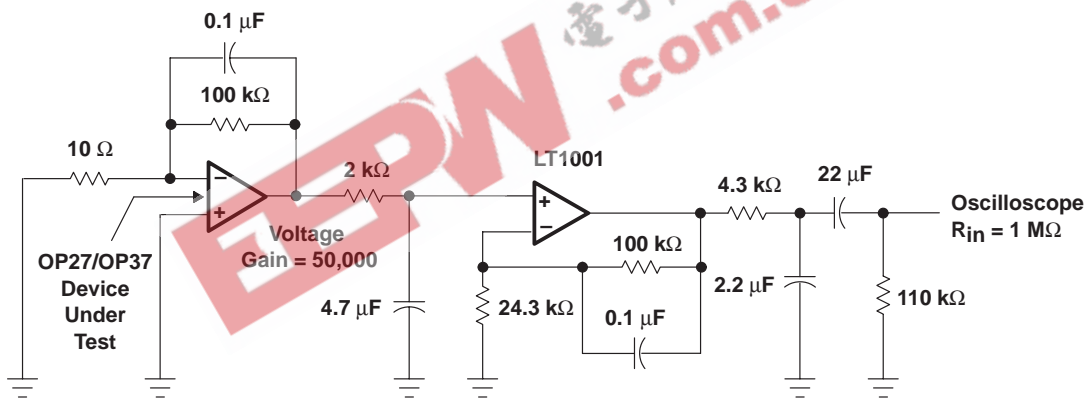
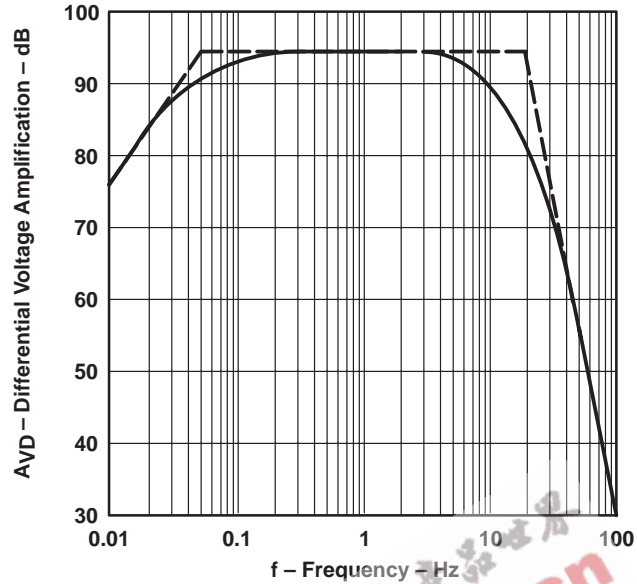

NOTE: All capacitor values are for nonpolarized capacitors only.

Figure 34. 0.1-Hz to 10-Hz Peak-to-Peak Noise Test Circuit and Frequency Response

**OP27A, OP27C, OP27E, OP27G
OP37A, OP37C, OP37E, OP37G
LOW-NOISE HIGH-SPEED PRECISION OPERATIONAL AMPLIFIERS**

SLOS100B – FEBRUARY 1989 – REVISED AUGUST 1994

APPLICATION INFORMATION

When measuring noise on a large number of units, a noise-voltage density test is recommended. A 10-Hz noise-voltage density measurement correlates well with a 0.1-Hz to 10-Hz peak-to-peak noise reading since both results are determined by the white noise and the location of the 1/f corner frequency.

Figure 35 shows a circuit measuring current noise and the formula for calculating current noise.

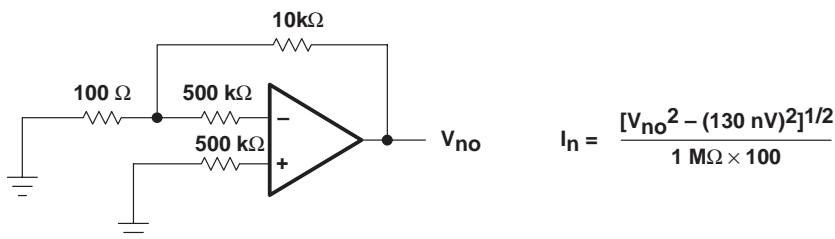

Figure 35. Current Noise Test Circuit and Formula

offset voltage adjustment

The input offset voltage and temperature coefficient of the OP27 and OP37 are permanently trimmed to a low level at wafer testing. However, if further adjustment of V_{IO} is necessary, using a 10-kΩ nulling potentiometer as shown in Figure 36 does not degrade the temperature coefficient $\alpha_{V_{IO}}$. Trimming to a value other than zero creates an $\alpha_{V_{IO}}$ of $V_{IO}/300 \mu\text{V}/^\circ\text{C}$. For example, if V_{IO} is adjusted to 300 μV , the change in $\alpha_{V_{IO}}$ is 1 $\mu\text{V}/^\circ\text{C}$.

The adjustment range with a 10-kΩ potentiometer is approximately $\pm 2.5 \text{ mV}$. If a smaller adjustment range is needed, the sensitivity and resolution of the nulling can be improved by using a smaller potentiometer in conjunction with fixed resistors. The example in Figure 37 has an approximate null range of $\pm 200 \mu\text{V}$.

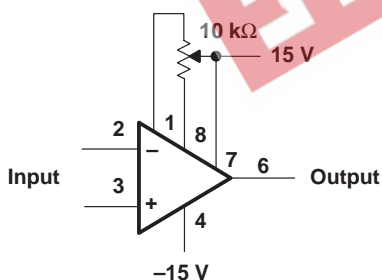

Figure 36. Standard Input Offset Voltage Adjustment

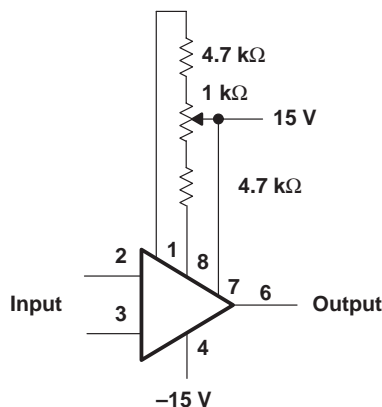

Figure 37. Input Offset Voltage Adjustment With Improved Sensitivity

offset voltage and drift

Unless proper care is exercised, thermoelectric effects caused by temperature gradients across dissimilar metals at the contacts to the input terminals can exceed the inherent temperature coefficient $\alpha_{V_{IO}}$ of the amplifier. Air currents should be minimized, package leads should be short, and the two input leads should be close together and at the same temperature.

APPLICATION INFORMATION

offset voltage and drift (continued)

The circuit shown in Figure 38 measures offset voltage. This circuit can also be used as the burn-in configuration for the OP27 and OP37 with the supply voltage increased to 20 V, $R_1 = R_3 = 10\text{ k}\Omega$, $R_2 = 200\ \Omega$, and $A_{VD} = 100$.

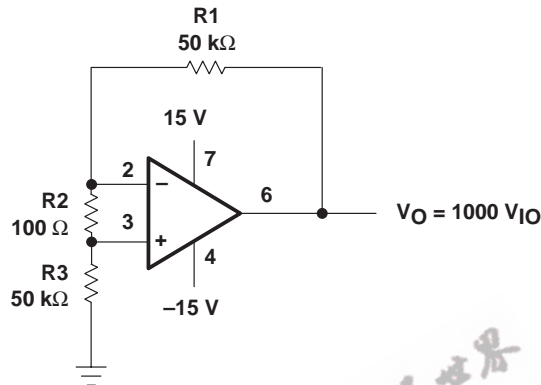

NOTE A: Resistors must have low thermoelectric potential.

Figure 38. Test Circuit for Offset Voltage and Offset Voltage Temperature Coefficient

unity gain buffer applications

The resulting output waveform, when $R_f \leq 100\ \Omega$ and the input is driven with a fast large-signal pulse ($> 1\text{ V}$), is shown in the pulsed-operation diagram in Figure 39.

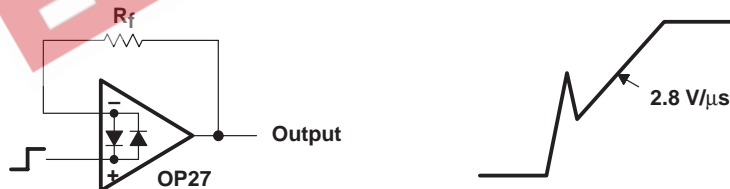

Figure 39. Pulsed Operation

During the initial (fast-feedthrough-like) portion of the output waveform, the input protection diodes effectively short the output to the input, and a current, limited only by the output short-circuit protection, is drawn by the signal generator. When $R_f \geq 500\ \Omega$, the output is capable of handling the current requirements (load current $\leq 20\text{ mA}$ at 10 V), the amplifier stays in its active mode, and a smooth transition occurs. When $R_f > 2\text{ k}\Omega$, a pole is created with R_f and the amplifier's input capacitance, creating additional phase shift and reducing the phase margin. A small capacitor (20 pF to 50 pF) in parallel with R_f eliminates this problem.

OP27A, OP27C, OP27E, OP27G
 OP37A, OP37C, OP37E, OP37G
 LOW-NOISE HIGH-SPEED PRECISION OPERATIONAL AMPLIFIERS

SLOS100B – FEBRUARY 1989 – REVISED AUGUST 1994

APPLICATION INFORMATION

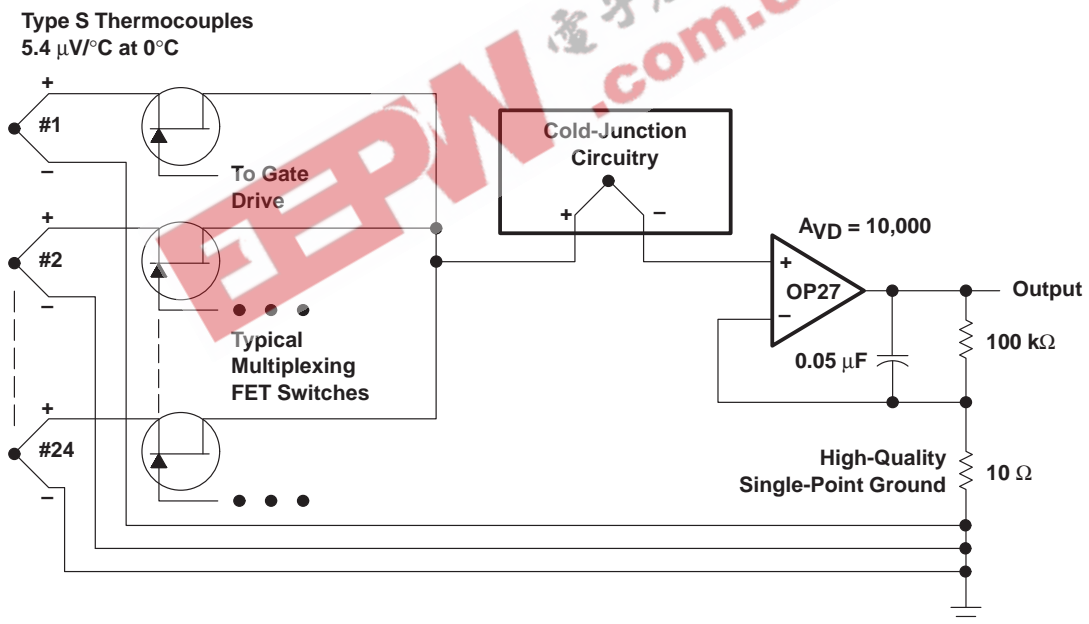
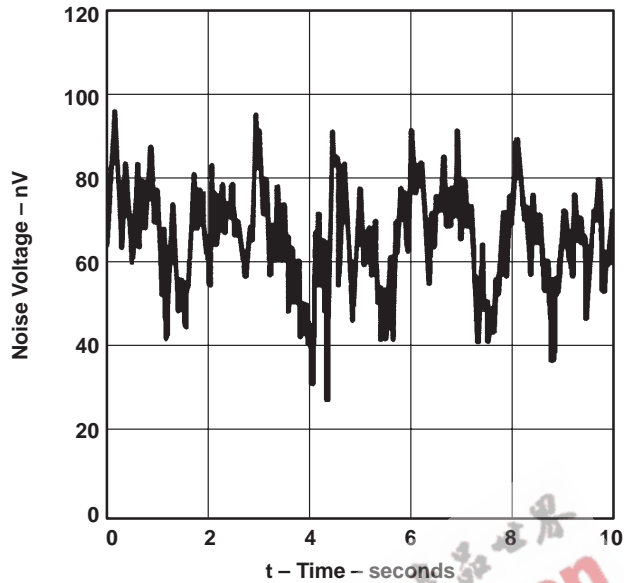

NOTE A: If 24 channels are multiplexed per second and the output is required to settle to 0.1 % accuracy, the amplifier's bandwidth cannot be limited to less than 30 Hz. The peak-to-peak noise contribution of the OP27 will still be only $0.11 \mu\text{V}$, which is equivalent to an error of only 0.02°C .

Figure 40. Low-Noise, Multiplexed Thermocouple Amplifier and 0.1-Hz To 10-Hz Peak-to-Peak Noise Voltage

IMPORTANT NOTICE

Texas Instruments and its subsidiaries (TI) reserve the right to make changes to their products or to discontinue any product or service without notice, and advise customers to obtain the latest version of relevant information to verify, before placing orders, that information being relied on is current and complete. All products are sold subject to the terms and conditions of sale supplied at the time of order acknowledgement, including those pertaining to warranty, patent infringement, and limitation of liability.

TI warrants performance of its semiconductor products to the specifications applicable at the time of sale in accordance with TI's standard warranty. Testing and other quality control techniques are utilized to the extent TI deems necessary to support this warranty. Specific testing of all parameters of each device is not necessarily performed, except those mandated by government requirements.

CERTAIN APPLICATIONS USING SEMICONDUCTOR PRODUCTS MAY INVOLVE POTENTIAL RISKS OF DEATH, PERSONAL INJURY, OR SEVERE PROPERTY OR ENVIRONMENTAL DAMAGE ("CRITICAL APPLICATIONS"). TI SEMICONDUCTOR PRODUCTS ARE NOT DESIGNED, AUTHORIZED, OR WARRANTED TO BE SUITABLE FOR USE IN LIFE-SUPPORT DEVICES OR SYSTEMS OR OTHER CRITICAL APPLICATIONS. INCLUSION OF TI PRODUCTS IN SUCH APPLICATIONS IS UNDERSTOOD TO BE FULLY AT THE CUSTOMER'S RISK.

In order to minimize risks associated with the customer's applications, adequate design and operating safeguards must be provided by the customer to minimize inherent or procedural hazards.

TI assumes no liability for applications assistance or customer product design. TI does not warrant or represent that any license, either express or implied, is granted under any patent right, copyright, mask work right, or other intellectual property right of TI covering or relating to any combination, machine, or process in which such semiconductor products or services might be or are used. TI's publication of information regarding any third party's products or services does not constitute TI's approval, warranty or endorsement thereof.