

Photologic® Slotted Optical Switches

Types OPB930L, OPB940L Series

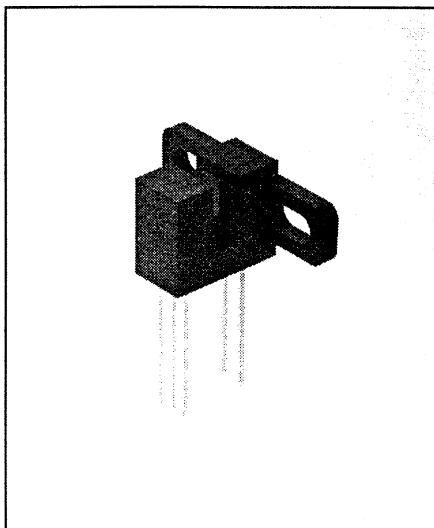

Features

- 0.320" (8.13 mm) lead space for PC board mount
- Choice of aperture
- Choice of output configuration
- Choice of opaque or IR transmissive shell material
- Data rates to 250 kBaud
- Side mount configuration

Description

The OPB930L and OPB940L series of Photologic® Photo Integrated Circuit Switches provide optimum flexibility for the design engineer. Building from a standard housing with a 0.125" (3.18 mm) wide slot, the user can specify (1) type and polarity of TTL output, (2) discrete shell material, and (3) aperture width. Available with wire leads as OPB930W/OPB940W series.

The electrical output can be specified as either TTL totem pole or TTL open collector. Either may be supplied with inverter or buffer output polarity. All have added stability of a built-in hysteresis amplifier.

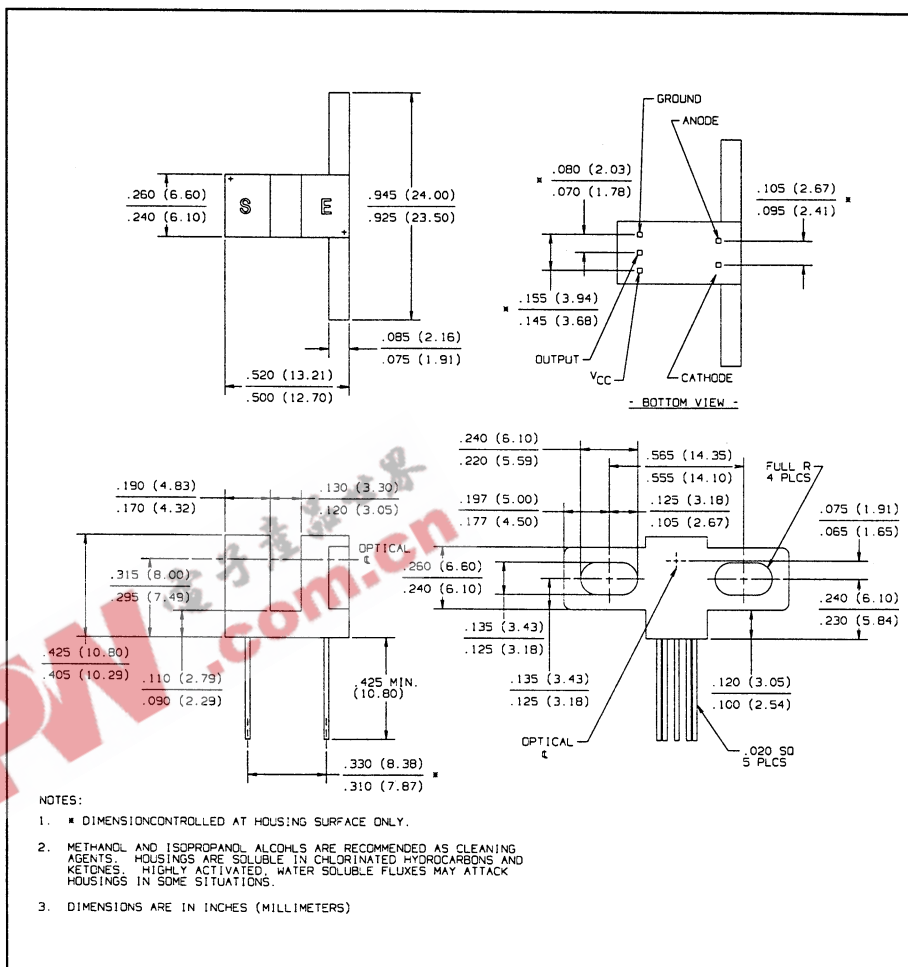

Absolute Maximum Ratings (TA = 25° C unless otherwise noted)

Supply Voltage, VCC (Not to exceed 3 sec.)	10 V
Storage Temperature Range	-40° C to +85° C
Operating Temperature Range	-40° C to +70° C
Lead Soldering Temperature [1/16 inch (1.6mm) from case for 5 sec. with soldering iron].	240° C ⁽¹⁾
Input Diode Power Dissipation	100 mW ⁽²⁾
Output Photologic® Power Dissipation	200 mW ⁽³⁾
Total Device Power Dissipation	300 mW ⁽⁴⁾
Voltage at Output Lead (Open Collector Output)	35 V
Diode Forward D.C. Current	40 mA
Diode Reverse D.C. Voltage	2 V

Notes:

- (1) RMA flux is recommended. Duration can be extended to 10 sec. max. when flow soldering.
- (2) Derate linearly 2.22 mW/° C above 25° C.
- (3) Derate linearly 4.44 mW/° C above 25° C.
- (4) Derate linearly 6.66 mW/° C above 25° C.
- (5) The OPB930L/OPB940L series are terminated with 0.020" square leads designed for printed circuit board mounting.
- (6) Methanol and isopropanol are recommended as cleaning agents. Plastic housing is soluble in chlorinated hydrocarbons and ketones.
- (7) Normal application would be with light source blocked, simulated by I_f = 0 mA.
- (8) All parameters tested using pulse technique.

Types OPB930L, OPB940L Series

Electrical Characteristics ($T_A = -40^\circ\text{C}$ to $+70^\circ\text{C}$ unless otherwise noted)

SYMBOL	PARAMETER	MIN	TYP	MAX	UNITS	TEST CONDITIONS
Input Diode						
V_F	Forward Voltage			1.7	V	$I_F = 20\text{ mA}$, $T_A = 25^\circ\text{C}$
I_R	Reverse Current			100	μA	$V_R = 2\text{ V}$, $T_A = 25^\circ\text{C}$
Output Photologic[®] Sensor						
V_{CC}	Operating D.C. Supply Voltage	4.75		5.25	V	
I_{CCL}	Low Level Supply Current: Buffered Totem-Pole Output Buffered Open-Collector Output			15	mA	$V_{CC} = 5.25\text{ V}$, $I_F = 0\text{ mA}^{(7)}$
	Inverted Totem-Pole Output Inverted Open-Collector Output			15	mA	$V_{CC} = 5.25\text{ V}$, $I_F = 15\text{ mA}$
I_{CCH}	High Level Supply Current: Buffered Totem-Pole Output Buffered Open-Collector Output			15	mA	$V_{CC} = 5.25\text{ V}$, $I_F = 15\text{ mA}$
	Inverted Totem-Pole Output Inverted Open-Collector Output			15	mA	$V_{CC} = 5.25\text{ V}$, $I_F = 0\text{ mA}^{(7)}$
V_{OL}	Low Level Output Voltage: Buffered Totem-Pole Output Buffered Open-Collector Output			0.4	V	$V_{CC} = 4.75\text{ V}$, $I_{OL} = 12.8\text{ mA}$ $I_F = 0\text{ mA}^{(7)}$
	Inverted Totem-Pole Output Inverted Open-Collector Output			0.4	V	$V_{CC} = 4.75\text{ V}$, $I_{OL} = 12.8\text{ mA}$ $I_F = 15\text{ mA}$
V_{OH}	High Level Output Voltage: Buffered Totem-Pole Output	2.4			V	$V_{CC} = 4.75\text{ V}$, $I_{OH} = -800\text{ mA}$ $I_F = 15\text{ mA}$
	Inverted Totem-Pole Output	2.4			V	$V_{CC} = 4.75\text{ V}$, $I_{OH} = -800\text{ mA}$ $I_F = 0\text{ mA}^{(7)}$
I_{OH}	High Level Output Current: Buffered Open-Collector Output			100	μA	$V_{CC} = 4.75\text{ V}$, $V_{OH} = 30\text{ V}$ $I_F = 15\text{ mA}$, $T_A = 25^\circ\text{C}$
	Inverted Open-Collector Output			100	μA	$V_{CC} = 4.75\text{ V}$, $V_{OH} = 30\text{ V}$ $I_F = 0\text{ mA}$, $T_A = 25^\circ\text{C}$
$I_{F(+)}$	LED Positive-Going Threshold Current			15	mA	$V_{CC} = 5\text{ V}$, $T_A = 25^\circ\text{C}$
$I_{F(+)} / I_{F(-)}$	Hysteresis		2			$V_{CC} = 5\text{ V}$
I_{OS}	Short Circuit Output Current: Buffered Totem-Pole Output	-30		-100	mA	$V_{CC} = 5.25\text{ V}$, $I_F = 15\text{ mA}$ Output = GND
	Inverted Totem-Pole Output	-30		-100	mA	$V_{CC} = 5.25\text{ V}$, $I_F = 0\text{ mA}$ Output = GND
t_r, t_f	Output Rise Time, Output Fall Time		70		ns	$V_{CC} = 5\text{ V}$, $T_A = 25^\circ\text{C}$ $I_F = 0$ or 15 mA
t_{PLH}, t_{PHL}	Propagation Delay Low-High & High-Low		5		μs	$R_L = 8\text{ TTL Loads (Totem-Pole)}$ $R_L = 360\ \Omega$ (Open-Collector)

Housing

All housings are an opaque grade of injection-molded plastic to minimize the assembly's sensitivity to ambient radiation, both visible and near-infrared. Discrete shells (exposed on the parallel faces inside the device throat) are either IR transmissive plastic for applications where aperture contamination may occur or opaque plastic for maximum protection against ambient light.

Types OPB930L, OPB940L Series

PART NUMBER GUIDE

OPB 9 X X X X X

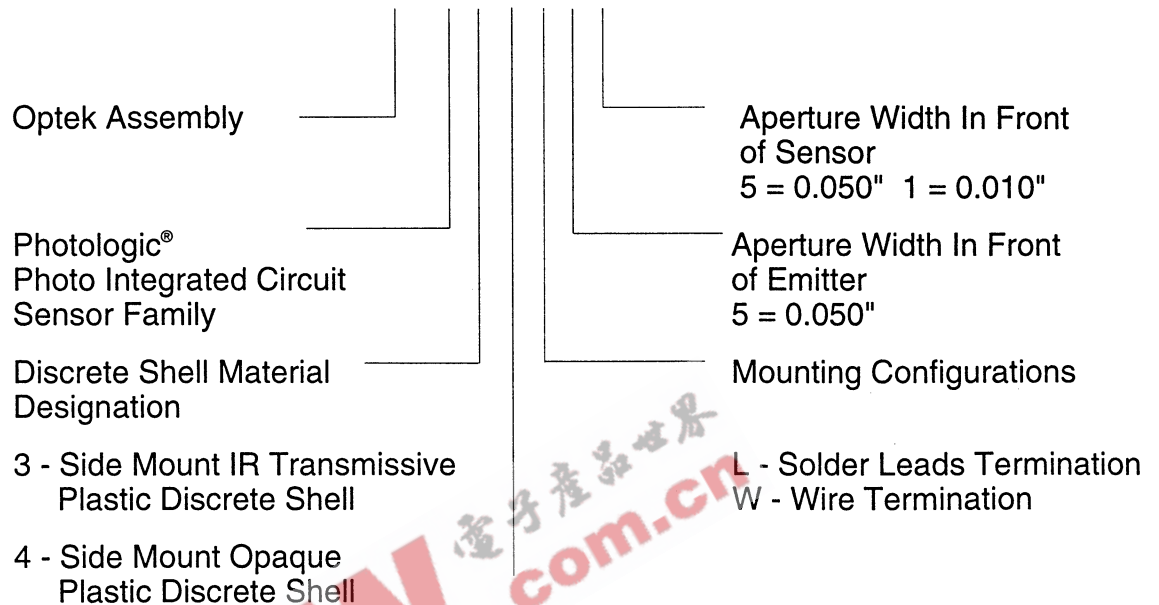

Electrical Specification Variations

- 0 - Buffered Totem-Pole Output
- 1 - Buffered Open-Collector Output
- 2 - Inverted Totem-Pole Output
- 3 - Inverted Open-Collector Output

Schematics

**OPB930, OPB940
(Totem-Pole Output)
Buffer**

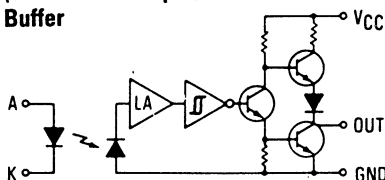

**OPB931, OPB941
(Open-Collector Output)
Buffer**

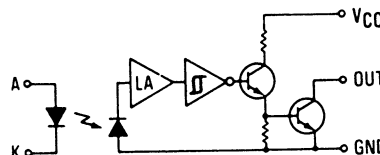

**OPB932, OPB942
(Totem-Pole Output)
Inverter**

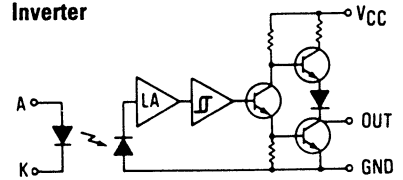

**OPB933, OPB943
(Open-Collector Output)
Inverter**

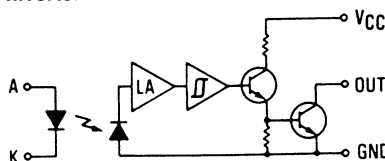

Types OPB930L, OPB940L Series

Typical Performance Curves

OPB930, OPB932, OPB940, OPB942

Output Voltage vs Ambient Temperature

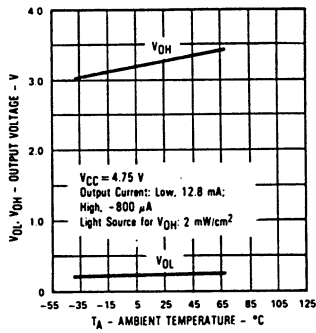

Short Circuit Output Current vs Ambient Temperature

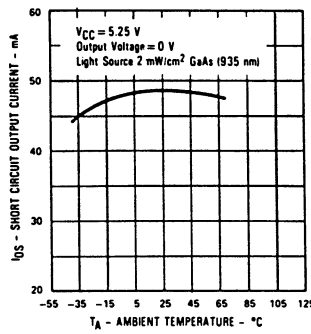

All Assemblies

Propagation Time vs Ambient Temperature

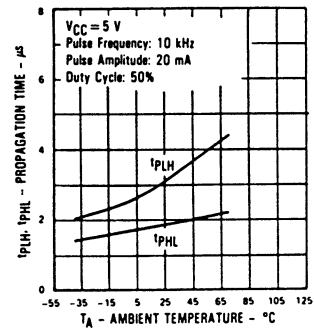

OPB931, OPB933, OPB941, OPB943

Output Current (High) vs Ambient Temperature

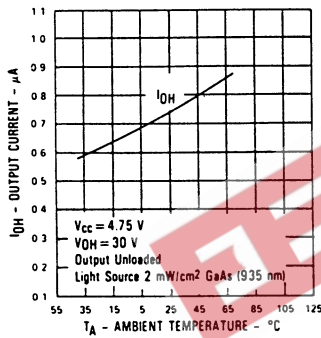

Rise Time and Fall Time vs Ambient Temperature

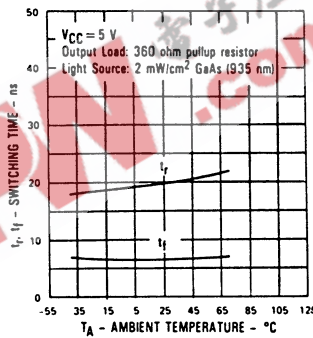

All Assemblies

Data Rate vs Ambient Temperature

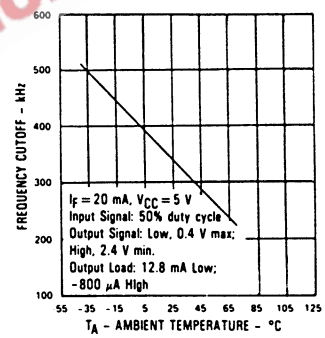

OPB930, OPB931, OPB940, OPB941

Normalized Supply Current vs Ambient Temperature

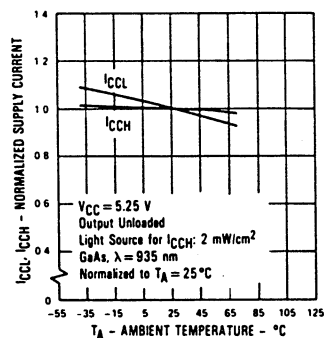

OPB932, OPB933, OPB942, OPB943

Normalized Supply Current vs Ambient Temperature

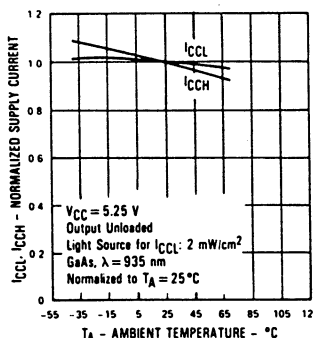

All Assemblies

Trigger Current vs Ambient Temperature

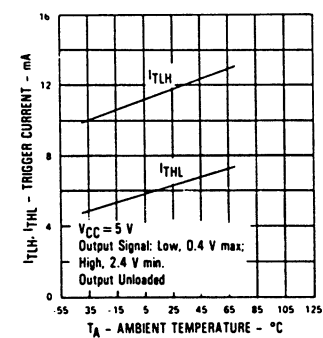

Switching Test Curve for Buffers

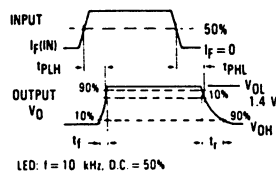

Switching Test Curve for Inverters

