

**OPA336**  
**OPA2336**  
**OPA4336**

## SINGLE-SUPPLY, *MicroPOWER* CMOS OPERATIONAL AMPLIFIERS

### *MicroAmplifier™* Series

#### FEATURES

- SINGLE SUPPLY OPERATION
- RAIL-TO-RAIL OUTPUT (within 3mV)
- *MicroPOWER*:  $I_Q = 20\mu\text{A}/\text{Amplifier}$
- *MicroSIZE* PACKAGES
- LOW OFFSET VOLTAGE: 125 $\mu\text{V}$  max
- SPECIFIED FROM  $V_S = 2.3\text{V}$  to 5.5V
- SINGLE, DUAL, AND QUAD VERSIONS<sup>(1)</sup>

#### APPLICATIONS

- BATTERY POWERED INSTRUMENTS
- PORTABLE DEVICES
- HIGH IMPEDANCE APPLICATIONS
- PHOTODIODE PRE-AMPS
- PRECISION INTEGRATORS
- MEDICAL INSTRUMENTS
- TEST EQUIPMENT

#### DESCRIPTION

OPA336 series micropower CMOS operational amplifiers are designed for battery powered applications. They operate on a single supply with operation as low as 2.1V. The output is rail-to-rail and swings to within 3mV of the supplies with a 100k $\Omega$  load. The common-mode range extends to the negative supply—ideal for single-supply applications. Single, dual, and quad versions have identical specifications for maximum design flexibility.

In addition to small size and low quiescent current (20 $\mu\text{A}/\text{amplifier}$ ), they feature low offset voltage (125 $\mu\text{V}$  max), low input bias current (1pA), and high open-loop gain (115dB). Dual and quad designs feature completely independent circuitry for lowest crosstalk and freedom from interaction.

OPA336 packages are the tiny 5-lead SOT-23-5 surface mount, SO-8 surface-mount, and 8-pin DIP. OPA2336 comes in the miniature MSOP-8 surface-mount, SO-8 surface-mount, and 8-pin DIP packages. OPA4336 packages are the space-saving SSOP-16 surface-mount and the 14-pin DIP. All are specified from  $-40^\circ\text{C}$  to  $+85^\circ\text{C}$  and operate from  $-55^\circ\text{C}$  to  $+125^\circ\text{C}$ . A macromodel is available for design analysis.

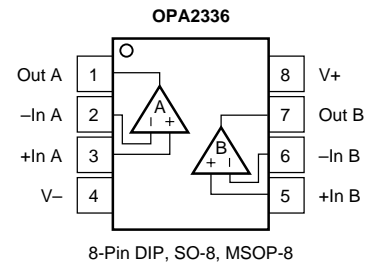
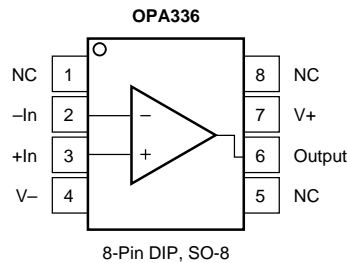
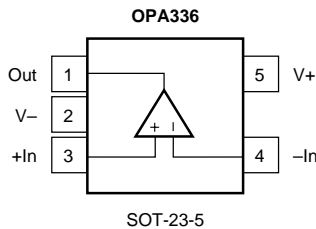

# SPECIFICATIONS: $V_S = 2.3V$ to $5.5V$

At  $T_A = +25^\circ C$ , and  $R_L = 25k\Omega$  connected to  $V_S/2$ , unless otherwise noted.

**Boldface** limits apply over the specified temperature range,  $-40^\circ C$  to  $+85^\circ C$ .  $V_S = +5V$ .

PARAMETER	CONDITION	OPA336N, P, U OPA2336E, P, U			OPA336NA, PA, UA OPA2336EA, PA, UA OPA4336EA, PA			UNITS
		MIN	TYP <sup>(1)</sup>	MAX	MIN	TYP <sup>(1)</sup>	MAX	
<b>OFFSET VOLTAGE</b> Input Offset Voltage vs Temperature vs Power Supply $T_A = -40^\circ C$ to $+85^\circ C$ Channel Separation, dc	$V_{OS}$ $dV_{OS}/dT$ PSRR		$\pm 60$ <b><math>\pm 1.5</math></b> 25 0.1	$\pm 125$ 100 <b>130</b>		*	$\pm 500$ *	$\mu V$ $\mu V/^\circ C$ $\mu V/V$ $\mu V/V$
<b>INPUT BIAS CURRENT</b> Input Bias Current $T_A = -40^\circ C$ to $+85^\circ C$ Input Offset Current	$I_B$ $I_{OS}$		$\pm 1$ $\pm 1$	$\pm 10$ <b><math>\pm 60</math></b> $\pm 10$		*	*	pA pA pA
<b>NOISE</b> Input Voltage Noise, $f = 0.1$ to $10$ Hz Input Voltage Noise Density, $f = 1$ kHz Current Noise Density, $f = 1$ kHz	$e_n$ $i_n$		3 40 30			*	*	$\mu Vp-p$ $nV/\sqrt{Hz}$ $fA/\sqrt{Hz}$
<b>INPUT VOLTAGE RANGE</b> Common-Mode Voltage Range Common-Mode Rejection Ratio $T_A = -40^\circ C$ to $+85^\circ C$	$V_{CM}$ CMRR	$-0.2V < V_{CM} < (V+) - 1V$ $-0.2V < V_{CM} < (V+) - 1V$	-0.2 80 <b>76</b>	90	$(V+) - 1$	*	86 *	V dB dB
<b>INPUT IMPEDANCE</b> Differential Common-Mode				$10^{13} \parallel 2$ $10^{13} \parallel 4$		*	*	$\Omega \parallel pF$ $\Omega \parallel pF$
<b>OPEN-LOOP GAIN</b> Open-Loop Voltage Gain $T_A = -40^\circ C$ to $+85^\circ C$ $T_A = -40^\circ C$ to $+85^\circ C$	$A_{OL}$	$R_L = 25k\Omega, 100mV < V_O < (V+) - 100mV$ $R_L = 25k\Omega, 100mV < V_O < (V+) - 100mV$ $R_L = 5k\Omega, 500mV < V_O < (V+) - 500mV$ $R_L = 5k\Omega, 500mV < V_O < (V+) - 500mV$	100 100 90 <b>90</b>	115 106	90 90 *	*	*	dB dB dB dB
<b>FREQUENCY RESPONSE</b> Gain-Bandwidth Product Slew Rate Overload Recovery Time	GBW SR	$V_S = 5V, G = 1$ $V_S = 5V, G = 1$ $V_{IN} * G = V_S$	100 0.03 100			*	*	kHz V/ $\mu s$ $\mu s$
<b>OUTPUT</b> Voltage Output Swing from Rail <sup>(2)</sup> $T_A = -40^\circ C$ to $+85^\circ C$ $T_A = -40^\circ C$ to $+85^\circ C$ Short-Circuit Current Capacitive Load Drive	$I_{SC}$ $C_{LOAD}$	$R_L = 100k\Omega, A_{OL} \geq 70dB$ $R_L = 25k\Omega, A_{OL} \geq 90dB$ $R_L = 25k\Omega, A_{OL} \geq 90dB$ $R_L = 5k\Omega, A_{OL} \geq 90dB$ $R_L = 5k\Omega, A_{OL} \geq 90dB$	3 20 70 $\pm 5$	100 <b>100</b> 500 <b>500</b>		*	*	mV mV mV mV mA pF
<b>POWER SUPPLY</b> Specified Voltage Range Minimum Operating Voltage Quiescent Current (per amplifier) $T_A = -40^\circ C$ to $+85^\circ C$	$V_S$ $I_Q$	$I_O = 0$ $I_O = 0$	2.3 2.1 20	5.5 32 <b>36</b>		*	*	V V $\mu A$ $\mu A$
<b>TEMPERATURE RANGE</b> Specified Range Operating Range Storage Range Thermal Resistance SOT-23-5 Surface-Mount MSOP-8 Surface-Mount SO-8 Surface-Mount 8-Pin DIP SSOP-16 Surface-Mount 14-Pin DIP	$\theta_{JA}$		-40 -55 -55	+85 +125 +125		*	*	$^\circ C$ $^\circ C$ $^\circ C$ $^\circ C/W$ $^\circ C/W$ $^\circ C/W$ $^\circ C/W$ $^\circ C/W$ $^\circ C/W$

\*Specifications same as OPA2336E, P, U.

NOTES: (1)  $V_S = +5V$ . (2) Output voltage swings are measured between the output and positive and negative power supply rails.

The information provided herein is believed to be reliable; however, BURR-BROWN assumes no responsibility for inaccuracies or omissions. BURR-BROWN assumes no responsibility for the use of this information, and all use of such information shall be entirely at the user's own risk. Prices and specifications are subject to change without notice. No patent rights or licenses to any of the circuits described herein are implied or granted to any third party. BURR-BROWN does not authorize or warrant any BURR-BROWN product for use in life support devices and/or systems.

## PIN CONFIGURATIONS

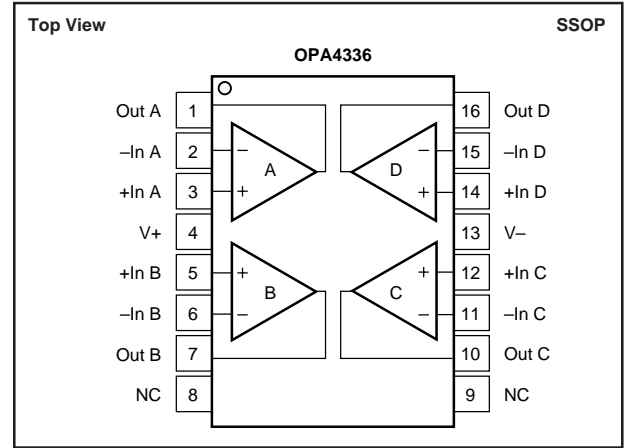
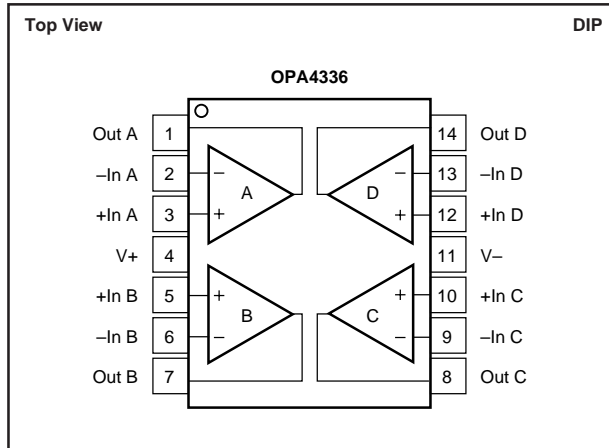

## ABSOLUTE MAXIMUM RATINGS<sup>(1)</sup>

Supply Voltage .....	5.5V
Signal Input Terminals, Voltage <sup>(2)</sup> .....	(V-) -0.3V to (V+) +0.3V
Current <sup>(2)</sup> .....	10mA
Output Short-Circuit <sup>(3)</sup> .....	Continuous
Operating Temperature .....	-55°C to +125°C
Storage Temperature .....	-55°C to +125°C
Junction Temperature .....	150°C
Lead Temperature (soldering, 10s) .....	300°C

NOTES: (1) Stresses above these ratings may cause permanent damage. (2) Input terminals are diode-clamped to the power supply rails. Input signals that can swing more than 0.3V beyond the supply rails should be current-limited to 10mA or less. (3) Short-circuit to ground, one amplifier per package.



## ELECTROSTATIC DISCHARGE SENSITIVITY

This integrated circuit can be damaged by ESD. Burr-Brown recommends that all integrated circuits be handled with appropriate precautions. Failure to observe proper handling and installation procedures can cause damage.

ESD damage can range from subtle performance degradation to complete device failure. Precision integrated circuits may be more susceptible to damage because very small parametric changes could cause the device not to meet its published specifications.

## PACKAGE/ORDERING INFORMATION

PRODUCT	PACKAGE	PACKAGE DRAWING NUMBER <sup>(1)</sup>	SPECIFIED TEMPERATURE RANGE	PACKAGE MARKING	ORDERING NUMBER <sup>(2)</sup>	TRANSPORT MEDIA
<b>Single</b>						
OPA336NA	5-Lead SOT-23-5	331	-40°C to +85°C	A36 <sup>(3)</sup>	OPA336NA-250	Tape and Reel
"	"	"	"	"	OPA336NA-3K	Tape and Reel
OPA336N	5-Lead SOT-23-5	331	-40°C to +85°C	A36 <sup>(3)</sup>	OPA336N-250	Tape and Reel
"	"	"	"	"	OPA336N-3K	Tape and Reel
OPA336PA	8-Pin DIP	006	-40°C to +85°C	OPA336PA	OPA336PA	Rails
OPA336P	8-Pin DIP	006	-40°C to +85°C	OPA336P	OPA336P	Rails
OPA336UA	SO-8 Surface-Mount	182	-40°C to +85°C	OPA336UA	OPA336UA	Rails <sup>(4)</sup>
OPA336U	SO-8 Surface-Mount	182	-40°C to +85°C	OPA336U	OPA336U	Rails <sup>(4)</sup>
<b>Dual</b>						
OPA2336PA	8-Pin DIP	006	-40°C to +85°C	OPA2336PA	OPA2336PA	Rails
OPA2336P	8-Pin DIP	006	-40°C to +85°C	OPA2336P	OPA2336P	Rails
OPA2336UA	SO-8 Surface-Mount	182	-40°C to +85°C	OPA2336UA	OPA2336UA	Rails <sup>(4)</sup>
OPA2336U	SO-8 Surface-Mount	182	-40°C to +85°C	OPA2336U	OPA2336U	Rails <sup>(4)</sup>
OPA2336EA	MSOP-8 Surface-Mount	337	-40°C to +85°C	B36 <sup>(3)</sup>	OPA2336EA-250	Tape and Reel
"	"	"	"	"	OPA2336EA-2500	Tape and Reel
OPA2336E	MSOP-8 Surface-Mount	337	-40°C to +85°C	B36 <sup>(3)</sup>	OPA2336E-250	Tape and Reel
"	"	"	"	"	OPA2336E-2500	Tape and Reel
<b>Quad</b>						
OPA4336EA	SSOP-16 Surface-Mount	322	-40°C to +85°C	OPA4336EA	OPA4336EA-250	Tape and Reel
"	"	"	"	"	OPA4336EA-2500	Tape and Reel
OPA4336PA	14-Pin DIP	010	-40°C to +85°C	OPA4336PA	OPA4336PA	Rails

NOTES: (1) For detailed drawing and dimension table, please see end of data sheet, or Appendix C of Burr-Brown IC Data Book. (2) Models with -250, -2500, and -3K are available only in Tape and Reel in the quantities indicated (e.g., -250 indicates 250 devices per reel). Ordering 3000 pieces of "OPA336NA-3K" will get a single 3000 piece Tape and Reel. For detailed Tape and Reel mechanical information, refer to Appendix B of Burr-Brown IC Data Book. (3) Grade will be marked on the Reel. (4) SO-8 models also available in Tape and Reel.

# TYPICAL PERFORMANCE CURVES

At  $T_A = +25^\circ\text{C}$ ,  $V_S = +5\text{V}$ , and  $R_L = 25\text{k}\Omega$  connected to  $V_S/2$ , unless otherwise noted.

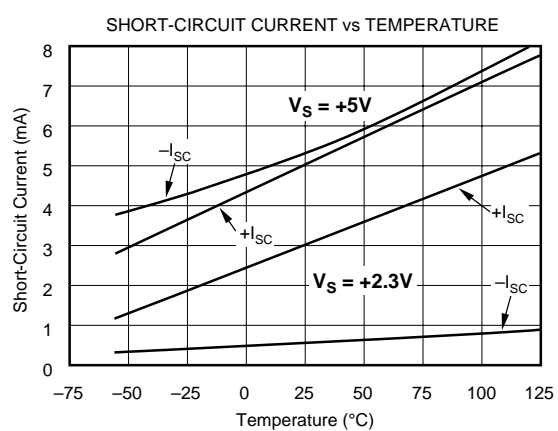
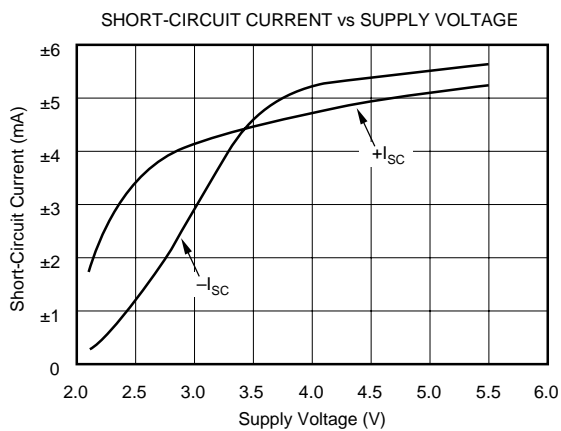
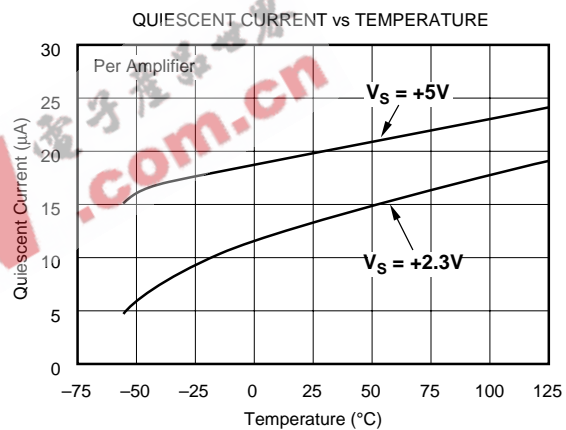
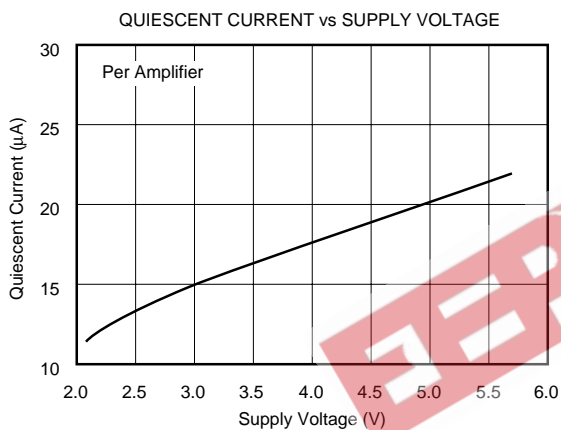
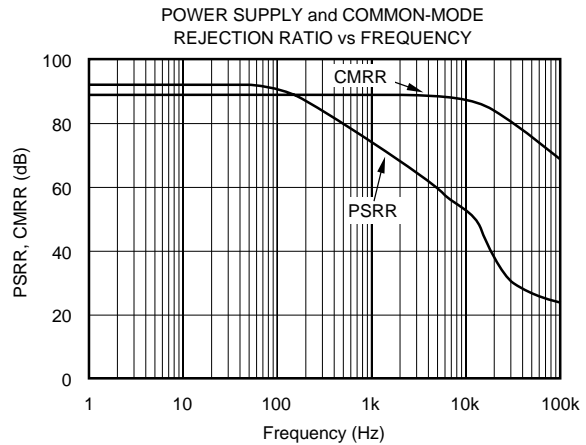
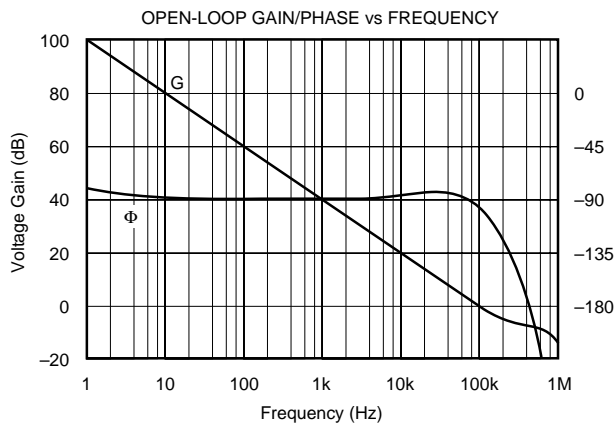

# TYPICAL PERFORMANCE CURVES (CONT)

At  $T_A = +25^\circ\text{C}$ ,  $V_S = +5\text{V}$ , and  $R_L = 25\text{k}\Omega$  connected to  $V_S/2$ , unless otherwise noted.

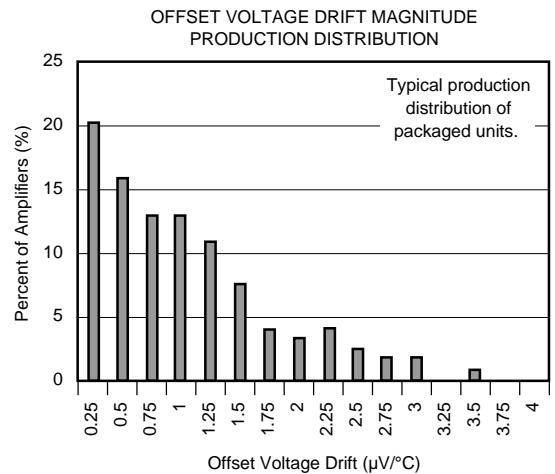
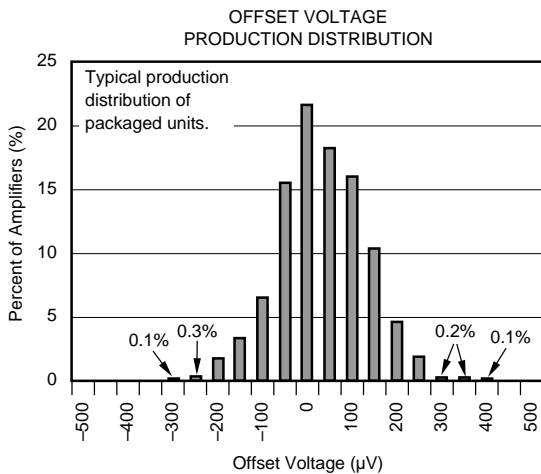
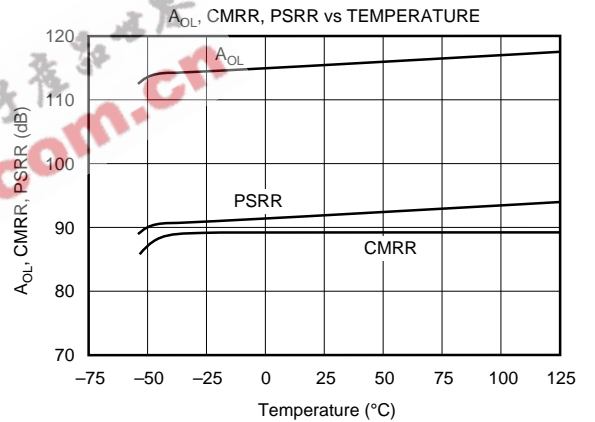
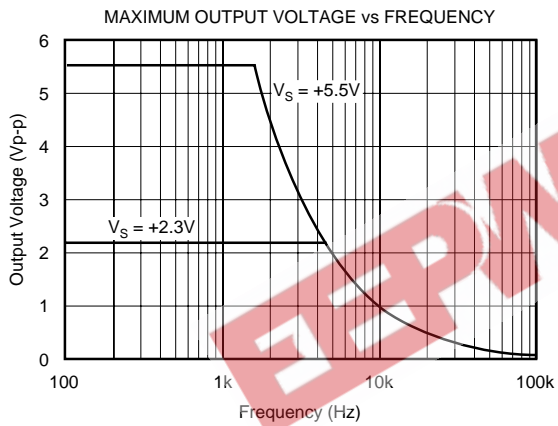
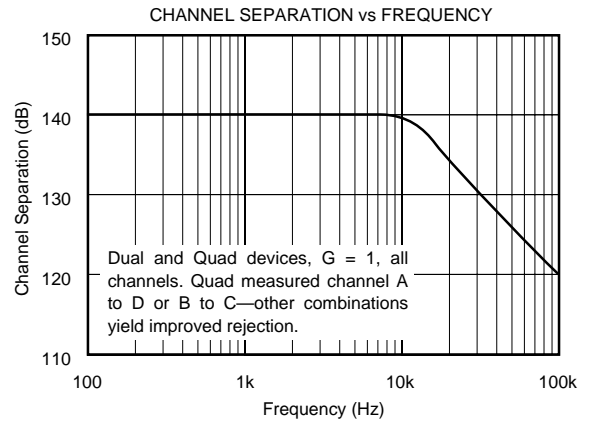
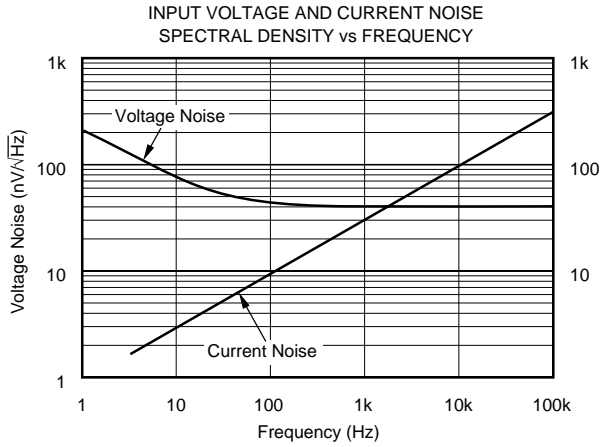

# TYPICAL PERFORMANCE CURVES (CONT)

At  $T_A = +25^\circ\text{C}$ ,  $V_S = +5\text{V}$ , and  $R_L = 25\text{k}\Omega$  connected to  $V_S/2$ , unless otherwise noted.

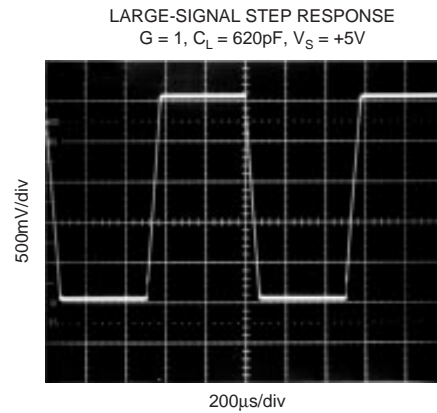
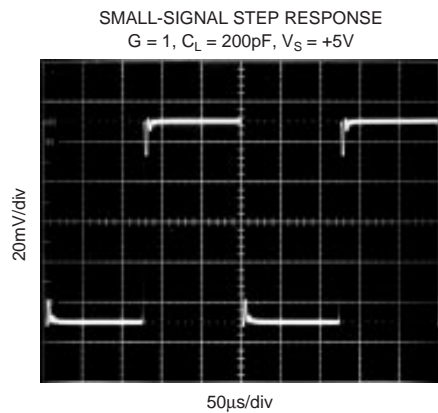
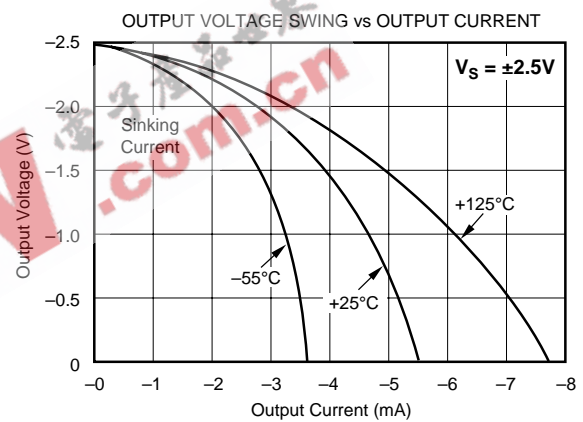
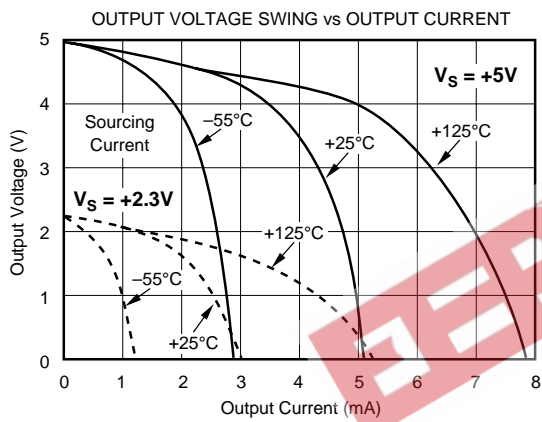
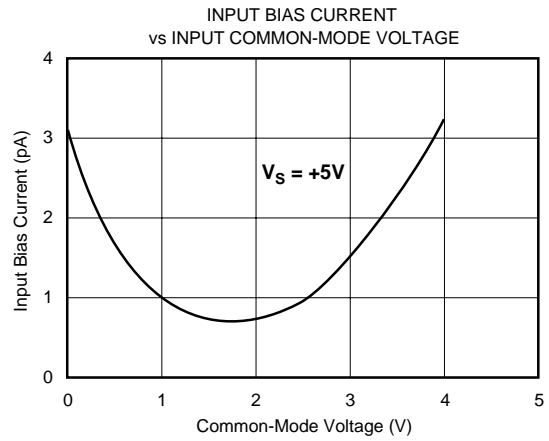
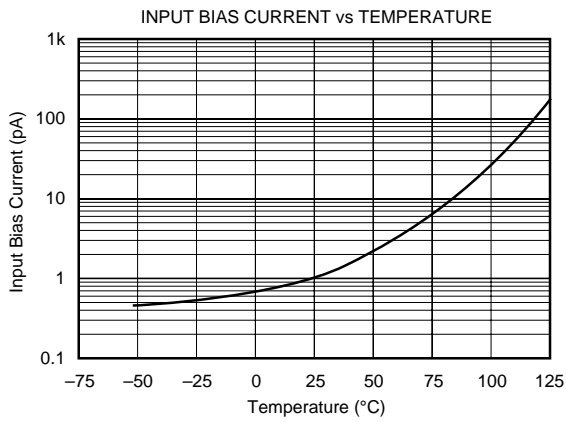

## APPLICATIONS INFORMATION

OPA336 series op amps are fabricated on a state-of-the-art 0.6 micron CMOS process. They are unity-gain stable and suitable for a wide range of general purpose applications. Power supply pins should be bypassed with 0.01 $\mu$ F ceramic capacitors. OPA336 series op amps are protected against reverse battery voltages.

### OPERATING VOLTAGE

OPA336 series op amps can operate from a +2.1V to +5.5V single supply with excellent performance. Most behavior remains unchanged throughout the full operating voltage range. Parameters which vary significantly with operating voltage are shown in the typical performance curves. OPA336 series op amps are fully specified for operation from +2.3V to +5.5V; a single limit applies over the supply range. In addition, many parameters are guaranteed over the specified temperature range,  $-40^{\circ}\text{C}$  to  $+85^{\circ}\text{C}$ .

### INPUT VOLTAGE

The input common-mode range of OPA336 series op amps extends from  $(V-)-0.2\text{V}$  to  $(V+)-1\text{V}$ . For normal operation, inputs should be limited to this range. The absolute maximum input voltage is 300mV beyond the supplies. Thus, inputs greater than the input common-mode range but less than maximum input voltage, while not valid, will not cause any damage to the op amp. Furthermore, the inputs may go beyond the power supplies without phase inversion (Figure 1) unlike some other op amps.

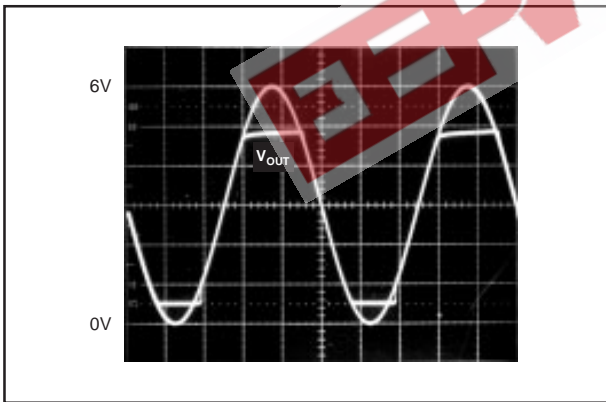

FIGURE 1. No Phase Inversion with Inputs Greater than the Power Supply Voltage.

Normally, input bias current is approximately 1pA. However, input voltages exceeding the power supplies can cause excessive current to flow in or out of the input pins. Momentary voltages greater than the power supply can be tolerated as long as the current on the input pins is limited to 10mA. This is easily accomplished with an input resistor as shown in Figure 2.

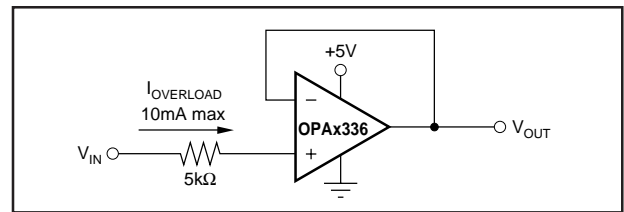

FIGURE 2. Input Current Protection for Voltages Exceeding the Supply Voltage.

### CAPACITIVE LOAD AND STABILITY

OPA336 series op amps can drive a wide range of capacitive loads. However, all op amps under certain conditions may become unstable. Op amp configuration, gain, and load value are just a few of the factors to consider when determining stability.

When properly configured, OPA336 series op amps can drive approximately 10,000pF. An op amp in unity gain configuration is the most vulnerable to capacitive load. The capacitive load reacts with the op amp's output resistance, along with any additional load resistance, to create a pole in the response which degrades the phase margin. In unity gain, OPA336 series op amps perform well with a pure capacitive load up to about 300pF. Increasing gain enhances the amplifier's ability to drive loads beyond this level.

One method of improving capacitive load drive in the unity gain configuration is to insert a 50 $\Omega$  to 100 $\Omega$  resistor inside the feedback loop as shown in Figure 3. This reduces ringing with large capacitive loads while maintaining DC accuracy.

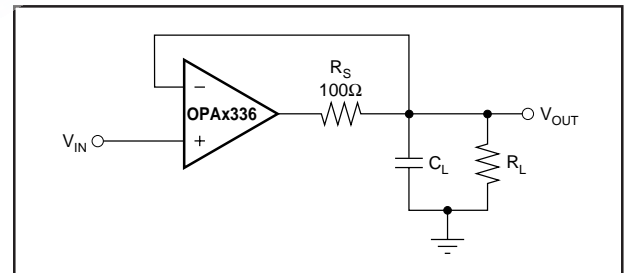

FIGURE 3. Series Resistor in Unity-Gain Configuration Improves Capacitive Load Drive.

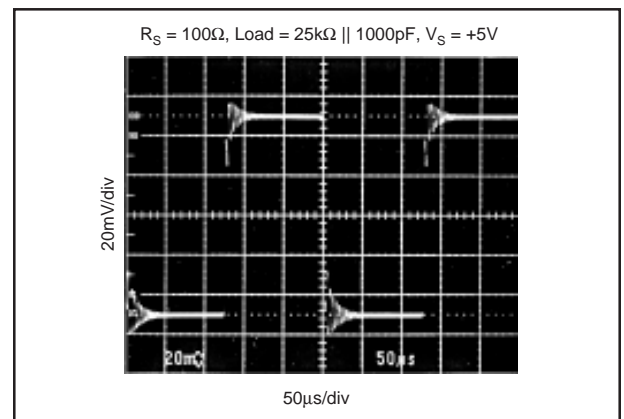

FIGURE 4. Small-Signal Step Response Using Series Resistor to Improve Capacitive Load Drive.

For example, with  $R_L = 25k\Omega$ , OPA336 series op amps perform well with capacitive loads in excess of 1000pF (Figure 4). Without  $R_S$ , capacitive load drive is typically 350pF for these conditions (see Figure 5).

Alternatively, the resistor may be connected in series with the output outside of the feedback loop. However, if there is a resistive load parallel to the capacitive load, it and the series resistor create a voltage divider. This introduces a DC error at the output. However, this error may be insignificant. For instance, with  $R_L = 100k\Omega$  and  $R_S = 100\Omega$ , there is only about a 0.1% error at the output.

Figure 5 shows the recommended operating regions for the OPA336. Decreasing the load resistance generally improves capacitive load drive. Figure 5 also illustrates how stability differs depending on where the resistive load is connected. With  $G = +1$  and  $R_L = 10k\Omega$  connected to  $V_S/2$ , the OPA336 can typically drive 500pF. Connecting the same load to ground improves capacitive load drive to 1000pF.

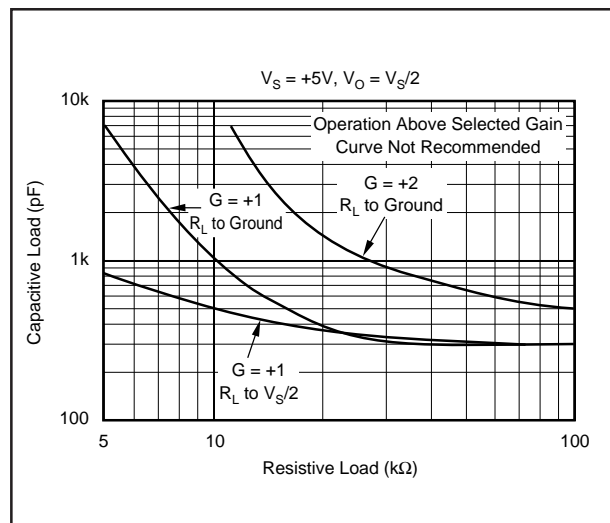

FIGURE 5. Stability—Capacitive Load vs Resistive Load.

EEPW 电子产品世界 .com.cn