

OPA337
OPA2337
OPA338
OPA2338

For most current data sheet and other product information, visit www.burr-brown.com

MicroSIZE, Single-Supply CMOS OPERATIONAL AMPLIFIERS MicroAmplifier™ Series

FEATURES

- **MicroSIZE PACKAGES:**
 SOT23-5
 SOT23-8
- **SINGLE-SUPPLY OPERATION**
- **RAIL-TO-RAIL OUTPUT SWING**
- **FET-INPUT: $I_B = 10\text{pA max}$**
- **HIGH SPEED:**
 OPA337: 3MHz, 1.2V/ μs ($G = 1$)
 OPA338: 12.5MHz, 4.6V/ μs ($G = 5$)
- **OPERATION FROM 2.5V to 5.5V**
- **HIGH OPEN-LOOP GAIN: 120dB**
- **LOW QUIESCENT CURRENT: 525 $\mu\text{A/amp}$**
- **SINGLE AND DUAL VERSIONS**

APPLICATIONS

- **BATTERY-POWERED INSTRUMENTS**
- **PHOTODIODE PRE-AMPS**
- **MEDICAL INSTRUMENTS**
- **TEST EQUIPMENT**
- **AUDIO SYSTEMS**
- **DRIVING ADCs**
- **CONSUMER PRODUCTS**

SPICE Model available at www.burr-brown.com

DESCRIPTION

The OPA337 and OPA338 series rail-to-rail output CMOS operational amplifiers are designed for low cost and miniature applications. Packaged in the new SOT23-8, the OPA2337EA and OPA2338EA are Burr-Brown's *smallest* dual op amps. At 1/4 the size of a conventional SO-8 surface mount, they are ideal for space-sensitive applications.

Utilizing advanced CMOS technology, OPA337 and OPA338 op amps provide low bias current, high-speed operation, high open-loop gain, and rail-to-rail output swing. They operate on a single supply with operation as low as 2.5V while drawing only 525 μA quiescent current. In addition, the input common-mode voltage range includes ground—ideal for single-supply operation.

The OPA337 series is unity-gain stable. The OPA338 series is optimized for gains greater than or equal to five. They are easy to use and free from phase inversion and overload problems found in some other op amps. Excellent performance is maintained as the amplifiers swing to their specified limits. The dual versions feature completely independent circuitry for lowest crosstalk and freedom from interaction, even when overdriven or overloaded.

PACKAGE	G = 1 STABLE		G ≥ 5 STABLE	
	SINGLE OPA337	DUAL OPA2337	SINGLE OPA338	DUAL OPA2338
SOT23-5	✓		✓	
SOT23-8		✓		✓
MSOP-8	✓			
SO-8	✓	✓	✓	✓
DIP-8	✓	✓		

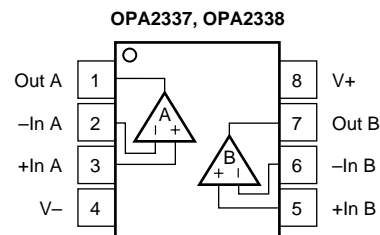
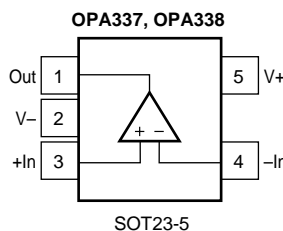
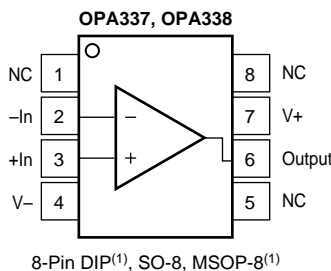

NOTE: (1) DIP AND MSOP-8 versions for OPA337, OPA2337 only.

International Airport Industrial Park • Mailing Address: PO Box 11400, Tucson, AZ 85734 • Street Address: 6730 S. Tucson Blvd., Tucson, AZ 85706 • Tel: (520) 746-1111
 Twx: 910-952-1111 • Internet: <http://www.burr-brown.com/> • Cable: BBRCORP • Telex: 066-6491 • FAX: (520) 889-1510 • Immediate Product Info: (800) 548-6132

SPECIFICATIONS: $V_S = 2.7V$ to $5.5V$

At $T_A = +25^\circ C$, and $R_L = 25k\Omega$ connected to $V_S/2$, unless otherwise noted.

Boldface limits apply over the specified temperature range, $-40^\circ C$ to $+85^\circ C$, $V_S = 5V$.

PARAMETER	CONDITION	OPA337NA, EA, UA, PA OPA2337EA, UA, PA OPA338NA, UA OPA2338EA, UA			UNITS
		MIN	TYP ⁽¹⁾	MAX	
OFFSET VOLTAGE Input Offset Voltage V_{OS} $T_A = -40^\circ C$ to $+85^\circ C$ vs Temperature dV_{OS}/dT vs Power Supply Rejection Ratio PSRR $T_A = -40^\circ C$ to $+85^\circ C$ Channel Separation (dual versions)	$V_S = 2.7V$ to $5.5V$ $V_S = 2.7V$ to $5.5V$ dc		± 0.5 ± 2 25 0.3	± 3 ± 3.5 125 125	mV mV $\mu V/^\circ C$ $\mu V/V$ $\mu V/V$
INPUT BIAS CURRENT Input Bias Current I_B $T_A = -40^\circ C$ to $+85^\circ C$ Input Offset Current I_{OS}			± 0.2 See Typical Curve ± 0.2	± 10 ± 10	pA pA
NOISE Input Voltage Noise, $f = 0.1Hz$ to $10Hz$ Input Voltage Noise Density, $f = 1kHz$ e_n Current Noise Density, $f = 1kHz$ i_n			6 26 0.6		$\mu Vp-p$ nV/\sqrt{Hz} fA/\sqrt{Hz}
INPUT VOLTAGE RANGE Common-Mode Voltage Range V_{CM} Common-Mode Rejection Ratio CMRR $T_A = -40^\circ C$ to $+85^\circ C$	$T_A = -40^\circ C$ to $+85^\circ C$ $-0.2V < V_{CM} < (V+) - 1.2V$ $-0.2V < V_{CM} < (V+) - 1.2V$	-0.2 74 74	90	(V+) - 1.2	V dB dB
INPUT IMPEDANCE Differential Common-Mode			$10^{13} \parallel 2$ $10^{13} \parallel 4$		$\Omega \parallel pF$ $\Omega \parallel pF$
OPEN-LOOP GAIN Open-Loop Voltage Gain A_{OL} $T_A = -40^\circ C$ to $+85^\circ C$ $T_A = -40^\circ C$ to $+85^\circ C$	$R_L = 25k\Omega$, $125mV < V_O < (V+) - 125mV$ $R_L = 25k\Omega$, $125mV < V_O < (V+) - 125mV$ $R_L = 5k\Omega$, $500mV < V_O < (V+) - 500mV$ $R_L = 5k\Omega$, $500mV < V_O < (V+) - 500mV$	100 100 100 100	120 114		dB dB dB dB
OPA337 FREQUENCY RESPONSE Gain-Bandwidth Product GBW Slew Rate SR Settling Time: 0.1% 0.01% Overload Recovery Time Total Harmonic Distortion + Noise THD+N	$V_S = 5V$, $G = 1$ $V_S = 5V$, $G = 1$ $V_S = 5V$, 2V Step, $C_L = 100pF$, $G = 1$ $V_S = 5V$, 2V Step, $C_L = 100pF$, $G = 1$ $V_{IN} \cdot G = V_S$ $V_S = 5V$, $V_O = 3Vp-p$, $G = 1$, $f = 1kHz$		3 1.2 2 2.5 2 0.001		MHz V/ μs μs μs μs %
OPA338 FREQUENCY RESPONSE Gain-Bandwidth Product GBW Slew Rate SR Settling Time: 0.1% 0.01% Overload Recovery Time Total Harmonic Distortion + Noise THD+N	$V_S = 5V$, $G = 5$ $V_S = 5V$, $G = 5$ $V_S = 5V$, 2V Step, $C_L = 100pF$, $G = 5$ $V_S = 5V$, 2V Step, $C_L = 100pF$, $G = 5$ $V_{IN} \cdot G = V_S$ $V_S = 5V$, $V_O = 3Vp-p$, $G = 5$, $f = 1kHz$		12.5 4.6 1.4 1.9 0.5 0.0035		MHz V/ μs μs μs μs %
OUTPUT Voltage Output Swing from Rail ⁽²⁾ $T_A = -40^\circ C$ to $+85^\circ C$ $T_A = -40^\circ C$ to $+85^\circ C$ Short-Circuit Current I_{SC} Capacitive Load Drive C_{LOAD}	$R_L = 25k\Omega$, $A_{OL} \geq 100dB$ $R_L = 25k\Omega$, $A_{OL} \geq 100dB$ $R_L = 5k\Omega$, $A_{OL} \geq 100dB$ $R_L = 5k\Omega$, $A_{OL} \geq 100dB$		40 150 ± 9	125 125 500 500	mV mV mV mV mA
POWER SUPPLY Specified Voltage Range V_S Minimum Operating Voltage Quiescent Current (per amplifier) I_Q $T_A = -40^\circ C$ to $+85^\circ C$	$T_A = -40^\circ C$ to $+85^\circ C$ $I_O = 0$ $I_O = 0$	2.7	2.5 0.525	5.5 1 1.2	V V mA mA

The information provided herein is believed to be reliable; however, BURR-BROWN assumes no responsibility for inaccuracies or omissions. BURR-BROWN assumes no responsibility for the use of this information, and all use of such information shall be entirely at the user's own risk. Prices and specifications are subject to change without notice. No patent rights or licenses to any of the circuits described herein are implied or granted to any third party. BURR-BROWN does not authorize or warrant any BURR-BROWN product for use in life support devices and/or systems.

SPECIFICATIONS: $V_S = 2.7V$ to $5.5V$ (Cont.)

At $T_A = +25^\circ C$, and $R_L = 25k\Omega$ connected to $V_S/2$, unless otherwise noted.

Boldface limits apply over the specified temperature range, $-40^\circ C$ to $+85^\circ C$, $V_S = 5V$.

PARAMETER	CONDITION	OPA337NA, EA, UA, PA OPA2337EA, UA, PA OPA338NA, UA OPA2338EA, UA			UNITS
		MIN	TYP	MAX	
TEMPERATURE RANGE					
Specified Range		-40		+85	$^\circ C$
Operating Range		-55		+125	$^\circ C$
Storage Range		-55		+125	$^\circ C$
Thermal Resistance	θ_{JA}				
SOT23-5 Surface Mount			200		$^\circ C/W$
SOT23-8 Surface Mount			200		$^\circ C/W$
MSOP-8			150		$^\circ C/W$
SO-8 Surface Mount			150		$^\circ C/W$
8-Pin DIP			100		$^\circ C/W$

NOTES: (1) $V_S = 5V$. (2) Output voltage swings are measured between the output and negative and positive power supply rails.

ABSOLUTE MAXIMUM RATINGS⁽¹⁾

Supply Voltage	5.5V
Input Voltage ⁽²⁾	(V-) -0.5V to (V+) +0.5V
Input Current ⁽²⁾	10mA
Output Short Circuit ⁽³⁾	Continuous
Operating Temperature	$-55^\circ C$ to $+125^\circ C$
Storage Temperature	$-55^\circ C$ to $+125^\circ C$
Junction Temperature	$150^\circ C$
Lead Temperature (soldering, 10s)	$300^\circ C$

NOTES: (1) Stresses above these ratings may cause permanent damage. Exposure to absolute maximum ratings for extended periods may degrade device reliability. (2) Input signal voltage is limited by internal diodes connected to power supplies. See text. (3) Short circuit to ground, one amplifier per package.

ELECTROSTATIC DISCHARGE SENSITIVITY

This integrated circuit can be damaged by ESD. Burr-Brown recommends that all integrated circuits be handled with appropriate precautions. Failure to observe proper handling and installation procedures can cause damage.

ESD damage can range from subtle performance degradation to complete device failure. Precision integrated circuits may be more susceptible to damage because very small parametric changes could cause the device not to meet its published specifications.

PACKAGE/ORDERING INFORMATION

PRODUCT	DESCRIPTION	PACKAGE	PACKAGE DRAWING NUMBER	SPECIFIED TEMPERATURE RANGE	PACKAGE MARKING	ORDERING NUMBER ⁽¹⁾	TRANSPORT MEDIA
OPA337 Series							
OPA337NA	Single, $G = 1$ Stable	5-Lead SOT23-5	331	$-40^\circ C$ to $+85^\circ C$	C37	OPA337NA/250	Tape and Reel
"	"	"	"	"	"	OPA337NA/3K	Tape and Reel
OPA337EA	Single, $G = 1$ Stable	MSOP-8	337	$-40^\circ C$ to $+85^\circ C$	G37	OPA337EA/250	Tape and Reel
"	"	"	"	"	"	OPA337EA/2K5	Tape and Reel
OPA337PA	Single, $G = 1$ Stable	8-Pin DIP	006	$-40^\circ C$ to $+85^\circ C$	OPA337PA	OPA337PA	Rails
OPA337UA	Single, $G = 1$ Stable	SO-8 Surface Mount	182	$-40^\circ C$ to $+85^\circ C$	OPA337UA	OPA337UA	Rails
"	"	"	"	"	"	OPA337UA/2K5	Tape and Reel
OPA2337 Series							
OPA2337EA	Dual, $G = 1$ Stable	8-Lead SOT23-8	348	$-40^\circ C$ to $+85^\circ C$	A7	OPA2337EA/250	Tape and Reel
"	"	"	"	"	"	OPA2337EA/3K	Tape and Reel
OPA2337PA	Dual, $G = 1$ Stable	8-Pin DIP	006	$-40^\circ C$ to $+85^\circ C$	OPA2337PA	OPA2337PA	Rails
OPA2337UA	Dual, $G = 1$ Stable	SO-8 Surface Mount	182	$-40^\circ C$ to $+85^\circ C$	OPA2337UA	OPA2337UA	Rails
"	"	"	"	"	"	OPA2337UA/2K5	Tape and Reel
OPA338 Series							
OPA338NA	Single, $G \geq 5$ Stable	5-Lead SOT23-5	331	$-40^\circ C$ to $+85^\circ C$	A38	OPA338NA/250	Tape and Reel
"	"	"	"	"	"	OPA338NA/3K	Tape and Reel
OPA338UA	Single, $G \geq 5$ Stable	SO-8 Surface Mount	182	$-40^\circ C$ to $+85^\circ C$	OPA338UA	OPA338UA	Rails
"	"	"	"	"	"	OPA338UA/2K5	Tape and Reel
OPA2338 Series							
OPA2338EA	Dual, $G \geq 5$ Stable	8-Lead SOT23-8	348	$-40^\circ C$ to $+85^\circ C$	A8	OPA2338EA/250	Tape and Reel
"	"	"	"	"	"	OPA2338EA/3K	Tape and Reel
OPA2338UA	Dual, $G \geq 5$ Stable	SO-8 Surface Mount	182	$-40^\circ C$ to $+85^\circ C$	OPA2338UA	OPA2338UA	Rails
"	"	"	"	"	"	OPA2338UA/2K5	Tape and Reel

NOTES: (1) Models with a slash (/) are available only in Tape and Reel in the quantities indicated (e.g., /2K5 indicates 2500 devices per reel). Ordering 2500 pieces of "OPA2337UA/2K5" will get a single 2500-piece Tape and Reel.

TYPICAL PERFORMANCE CURVES

At $T_A = +25^\circ\text{C}$, $V_S = +5\text{V}$, and $R_L = 25\text{k}\Omega$ connected to $V_S/2$, unless otherwise noted.

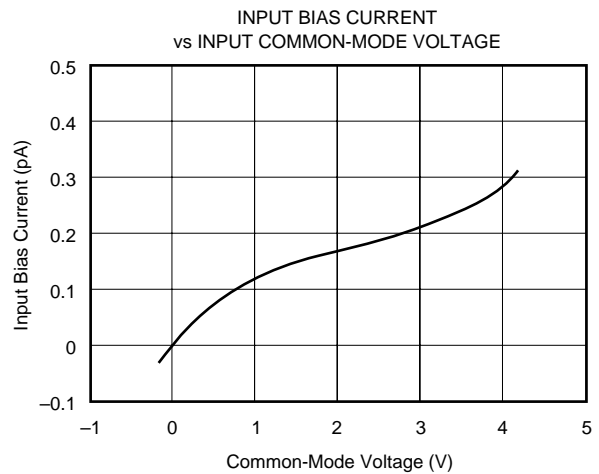
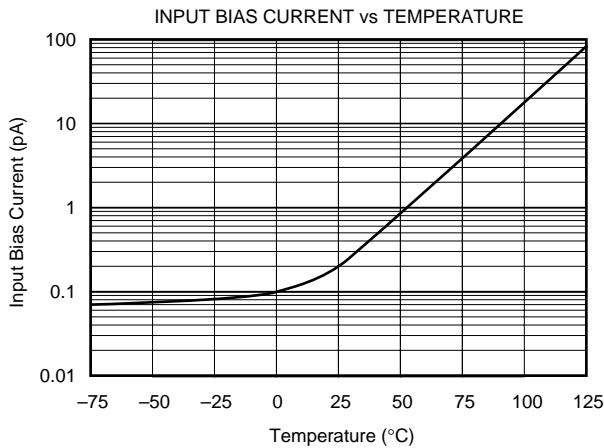
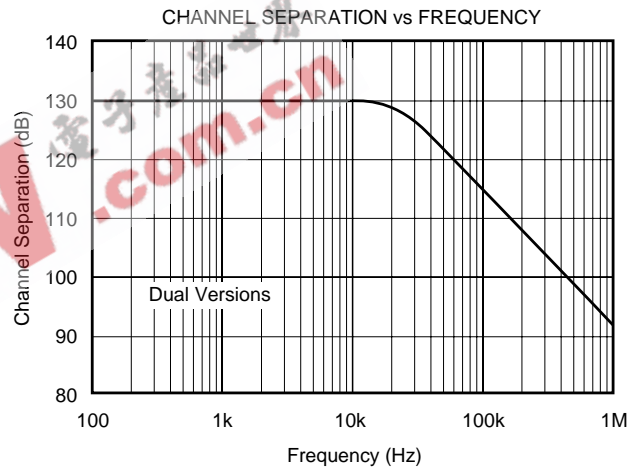
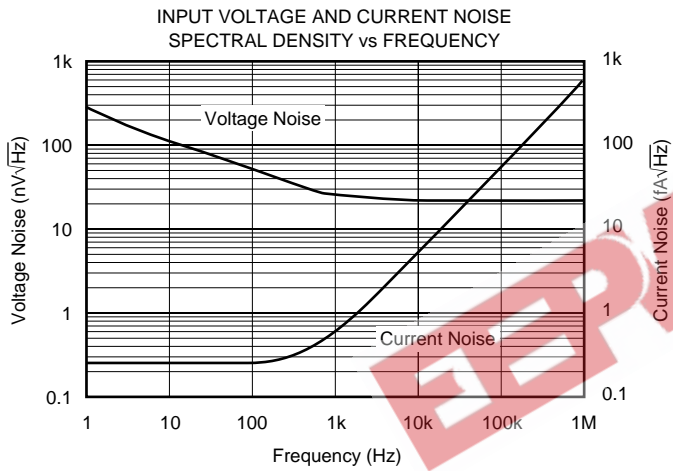
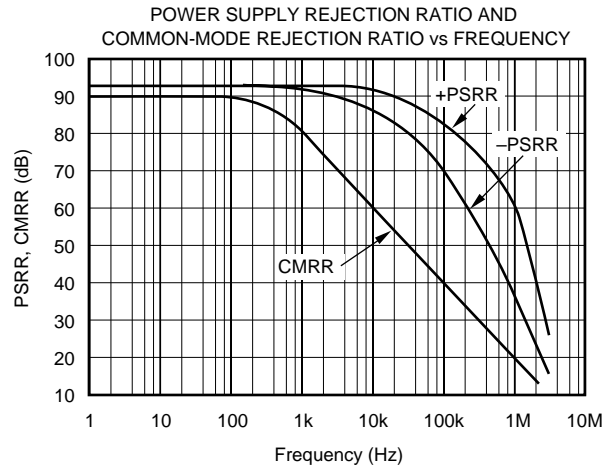
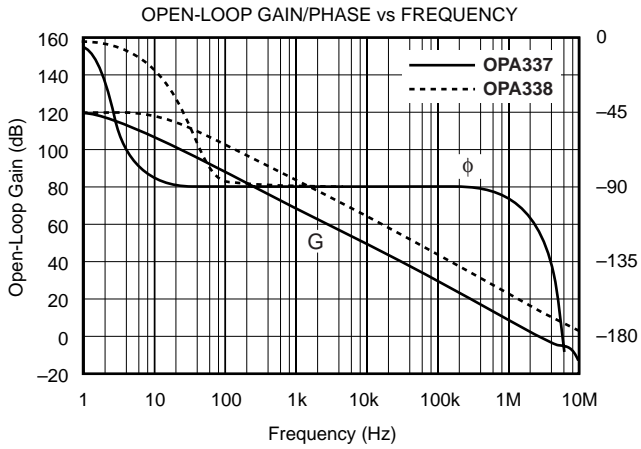

TYPICAL PERFORMANCE CURVES (Cont.)

At $T_A = +25^\circ\text{C}$, $V_S = +5\text{V}$, and $R_L = 25\text{k}\Omega$ connected to $V_S/2$, unless otherwise noted.

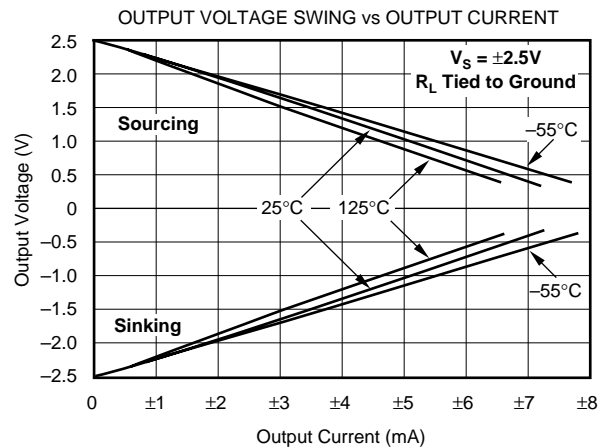
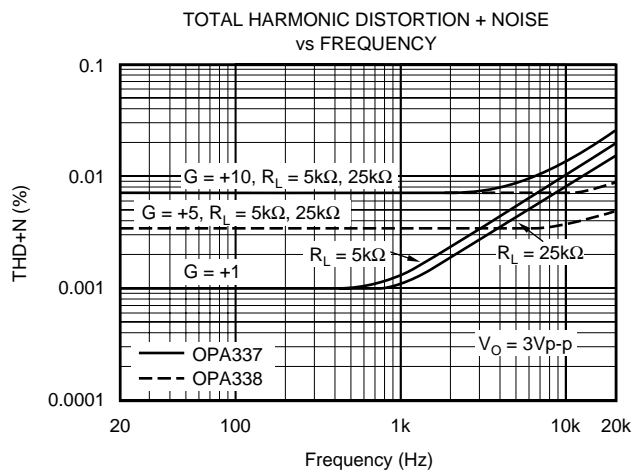
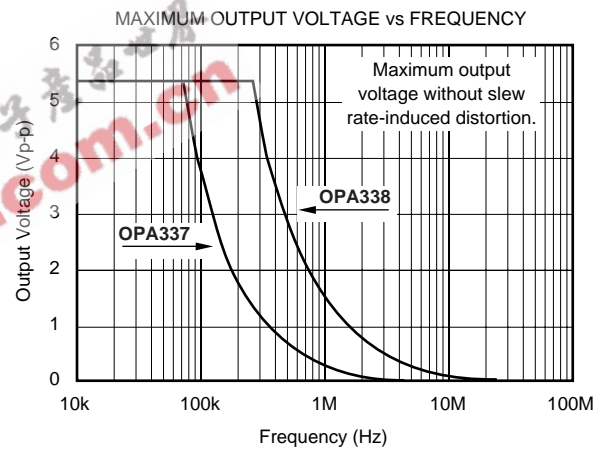
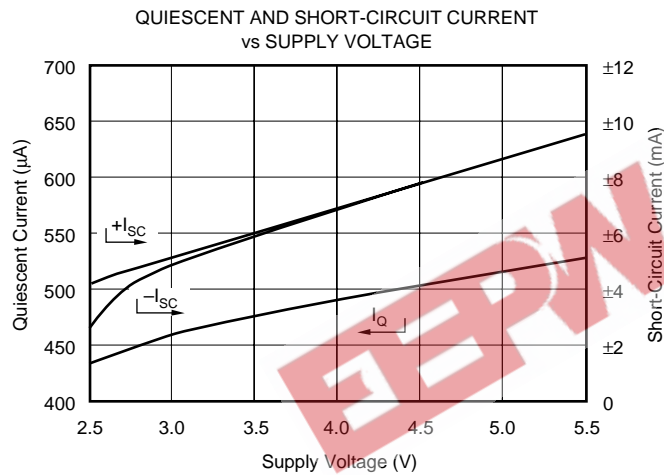
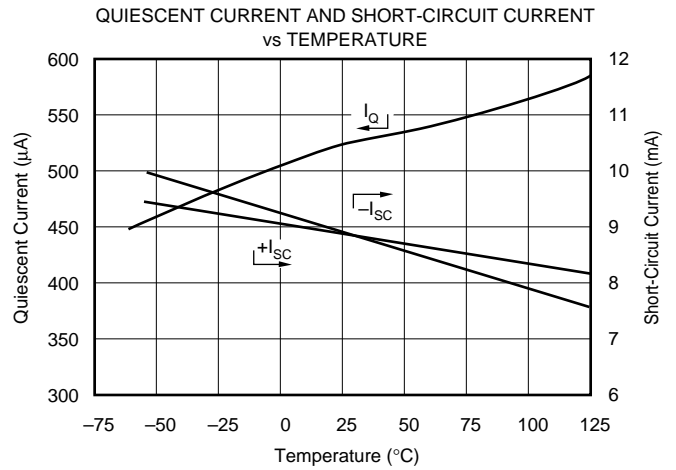
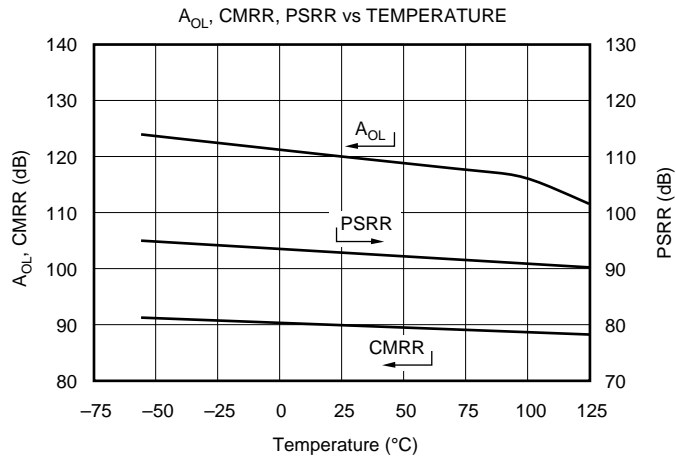

TYPICAL PERFORMANCE CURVES (Cont.)

At $T_A = +25^\circ\text{C}$, $V_S = +5\text{V}$, and $R_L = 25\text{k}\Omega$ connected to $V_S/2$, unless otherwise noted.

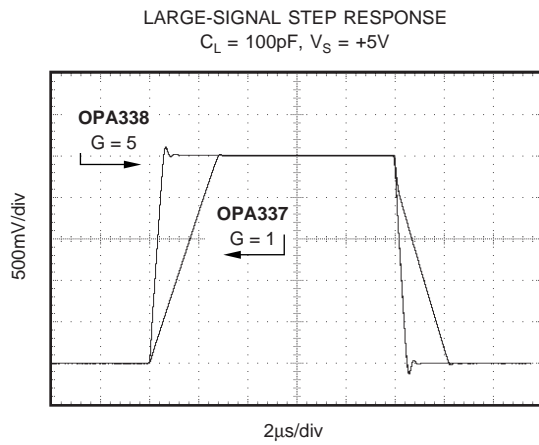
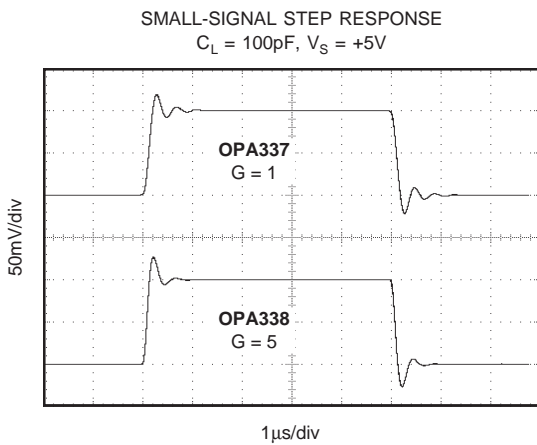
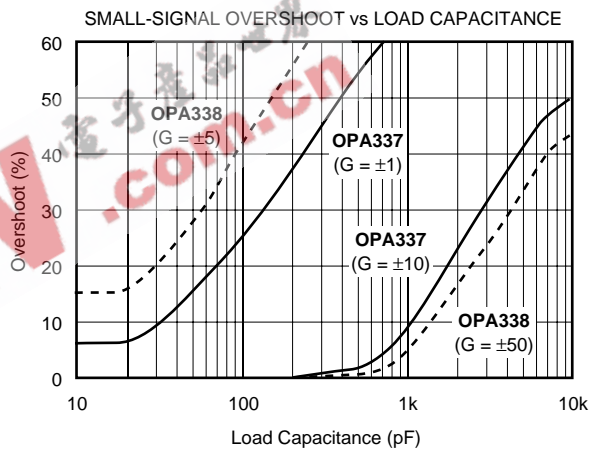
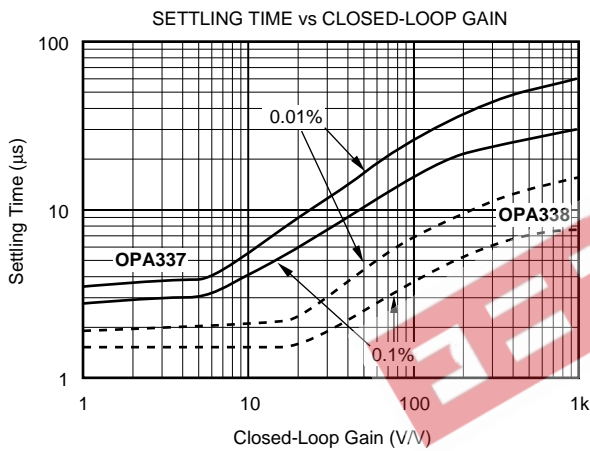
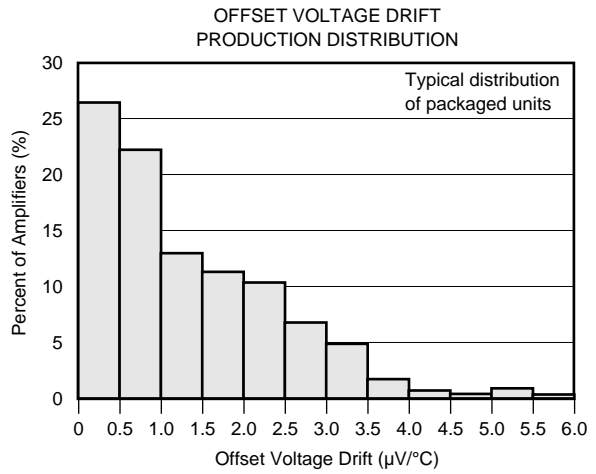
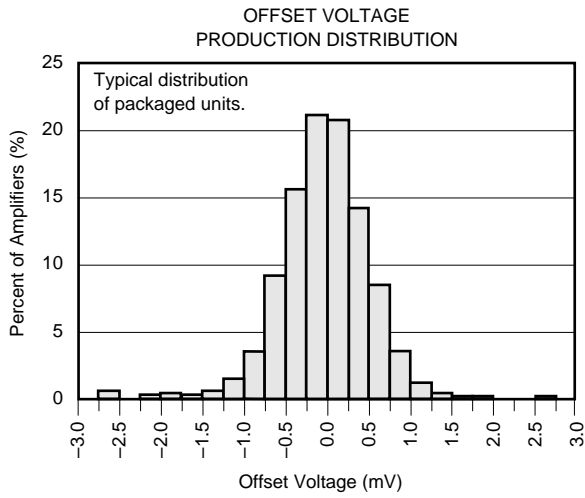

APPLICATIONS INFORMATION

The OPA337 series and OPA338 series are fabricated on a state-of-the-art CMOS process. The OPA337 series is unity-gain stable. The OPA338 series is optimized for gains greater than or equal to five. Both are suitable for a wide range of general purpose applications. Power supply pins should be bypassed with 0.01μF ceramic capacitors.

OPERATING VOLTAGE

The OPA337 series and OPA338 series can operate from a +2.5V to +5.5V single supply with excellent performance. Unlike most op amps which are specified at only one supply voltage, these op amps are specified for real-world applications; a single limit applies throughout the +2.7V to +5.5V supply range. This allows a designer to have the same assured performance at any supply voltage within the specified voltage range. Most behavior remains unchanged throughout the full operating voltage range. Parameters which vary significantly with operating voltage are shown in typical performance curves.

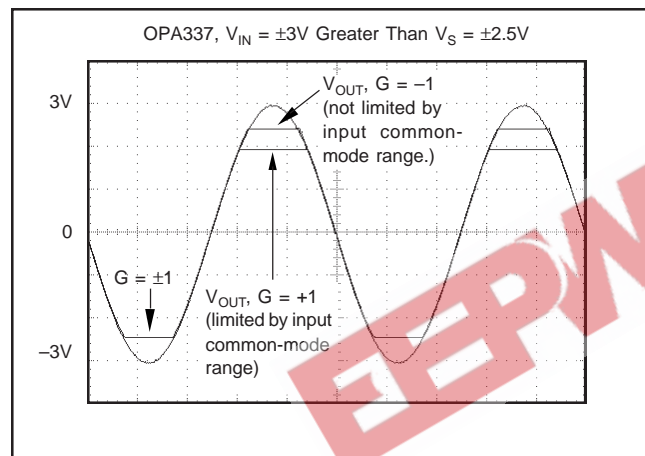

FIGURE 1. OPA337—No Phase Inversion with Inputs Greater than the Power Supply Voltage.

INPUT VOLTAGE

The input common-mode range extends from $(V-) - 0.2V$ to $(V+) - 1.2V$. For normal operation, inputs should be limited to this range. The absolute maximum input voltage is 500mV beyond the supplies. Inputs greater than the input common-mode range but less than maximum input voltage, while not valid, will not cause any damage to the op amp. Furthermore, if input current is limited the inputs may go beyond the power supplies without phase inversion (Figure 1) unlike some other op amps.

Normally, input currents are 0.2pA. However, large inputs (greater than 500mV beyond the supply rails) can cause excessive current to flow in or out of the input pins. Therefore, as well as keeping the input voltage below the maximum rating, it is also important to limit the input current to less than 10mA. This is easily accomplished with an input resistor as shown in Figure 2.

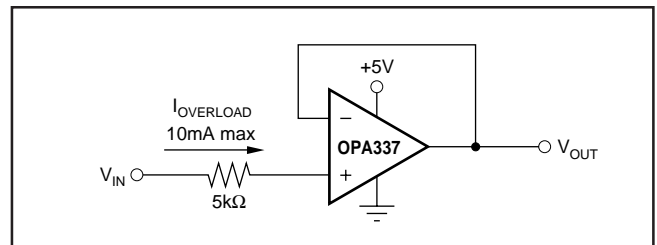

FIGURE 2. Input Current Protection for Voltages Exceeding the Supply Voltage.

USING THE OPA338 IN LOW GAINS

The OPA338 series is optimized for gains greater than or equal to five. It has significantly wider bandwidth (12.5MHz) and faster slew rate (4.6V/μs) when compared to the OPA337 series. The OPA338 series can be used in lower gain configurations at low frequencies while maintaining its high slew rate with the proper compensation.

Figure 3 shows the OPA338 in a unity-gain buffer configuration. At dc, the compensation capacitor C_1 is effectively “open” resulting in 100% feedback (closed-loop gain = 1). As frequency increases, C_1 becomes lower impedance and closed-loop gain increases, eventually becoming $1 + R_2/R_1$ (in this case five, which is equal to the minimum gain required for stability).

The required compensation capacitor value can be determined from the following equation:

$$C_1 = 1/(2\pi f_c R_1)$$

Since f_c may shift with process variations, it is recommended that a value less than f_c be used for determining C_1 . With $f_c = 1\text{MHz}$ and $R_1 = 2.5\text{k}\Omega$, the compensation capacitor is about 68pF.

The selection of the compensation capacitor C_1 is important. A proper value ensures that the closed-loop circuit gain is greater than or equal to five at high frequencies. Referring to the “Open-Loop Gain vs Frequency” plot in the Typical Performance Curves section, the OPA338 gain line (dashed in the curve) has a constant slope (–20dB/decade) up to approximately 3MHz. This frequency is referred to as f_c . Beyond f_c the slope of the curve increases, suggesting that closed-loop gains less than 5 are not appropriate.

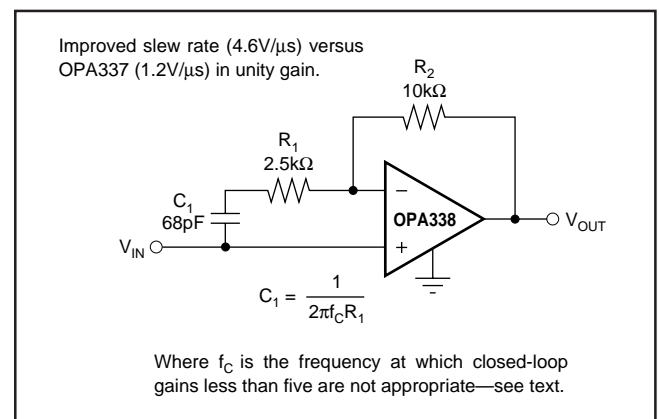

FIGURE 3. Compensation of OPA338 for Unity-Gain Buffer.

Figure 4 shows a compensation technique using an inverting configuration. The low frequency gain is set by the resistor ratio while the high frequency gain is set by the capacitor ratio. As with the noninverting circuit, for frequencies above f_C the gain must be greater than the recommended minimum stable gain for the op amp.

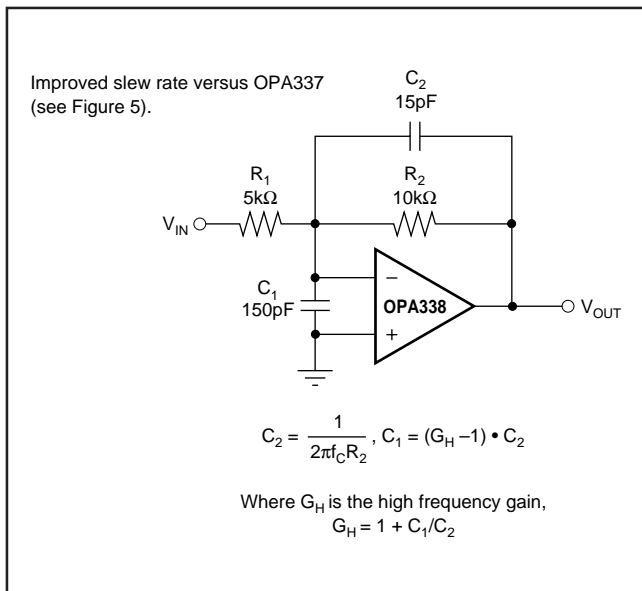

FIGURE 4. Inverting Compensation Circuit of OPA338 for Low Gain.

Resistors R_1 and R_2 are chosen to set the desired dc signal gain. Then the value for C_2 is determined as follows:

$$C_2 = 1 / (2\pi f_C R_2)$$

C_1 is determined from the desired high frequency gain (G_H):

$$C_1 = (G_H - 1) \cdot C_2$$

For a desired dc gain of 2 and high frequency gain of 10, the following resistor and capacitor values result:

$$\begin{aligned} R_1 &= 10\text{k}\Omega & C_1 &= 150\text{pF} \\ R_2 &= 5\text{k}\Omega & C_2 &= 15\text{pF} \end{aligned}$$

The capacitor values shown are the nearest standard values. Capacitor values may need to be adjusted slightly to optimize performance. For more detailed information, consult the OPA686 product data sheet.

Figure 5 shows the large-signal transient response using the circuit given in Figure 4. As shown, the OPA338 is stable in low gain applications and provides improved slew rate performance when compared to the OPA337.

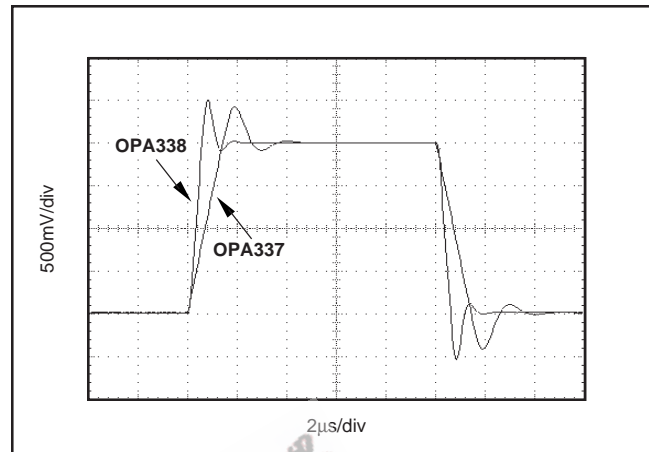

FIGURE 5. $G = 2$, Slew-Rate Comparison of OPA338 and OPA337.

TYPICAL APPLICATION

Figure 6 shows the OPA2337 in a typical application. The ADS7822 is a 12-bit, micro-power sampling analog-to-digital converter available in the tiny MSOP-8 package. As with the OPA2337, it operates with a supply voltage as low as +2.7V. When used with the miniature SOT23-8 package of the OPA2337, the circuit is ideal for space-limited and low power applications. In addition, OPA2337's high input impedance allows large value resistors to be used which results in small physical capacitors, further reducing circuit size. For further information, consult the ADS7822 product data sheet.

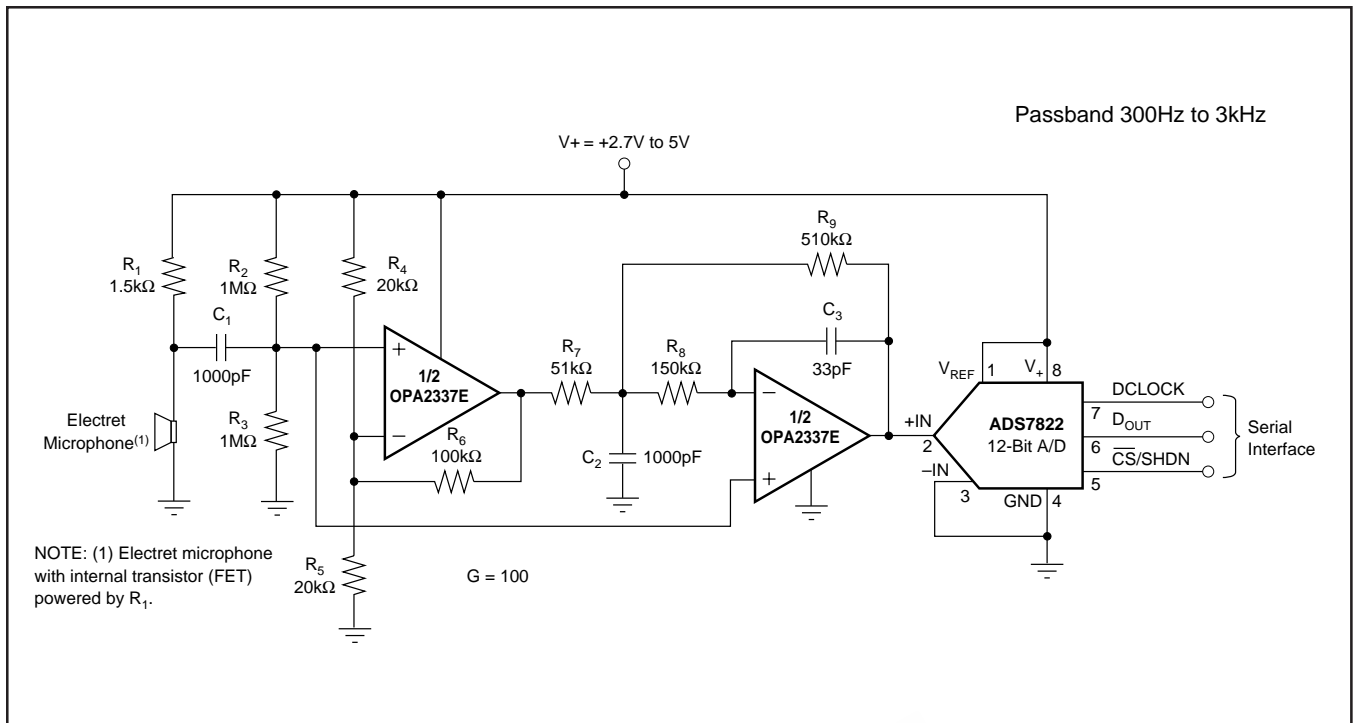

FIGURE 6. Low Power, Single-Supply, Speech Bandpass Filtered Data Acquisition System.

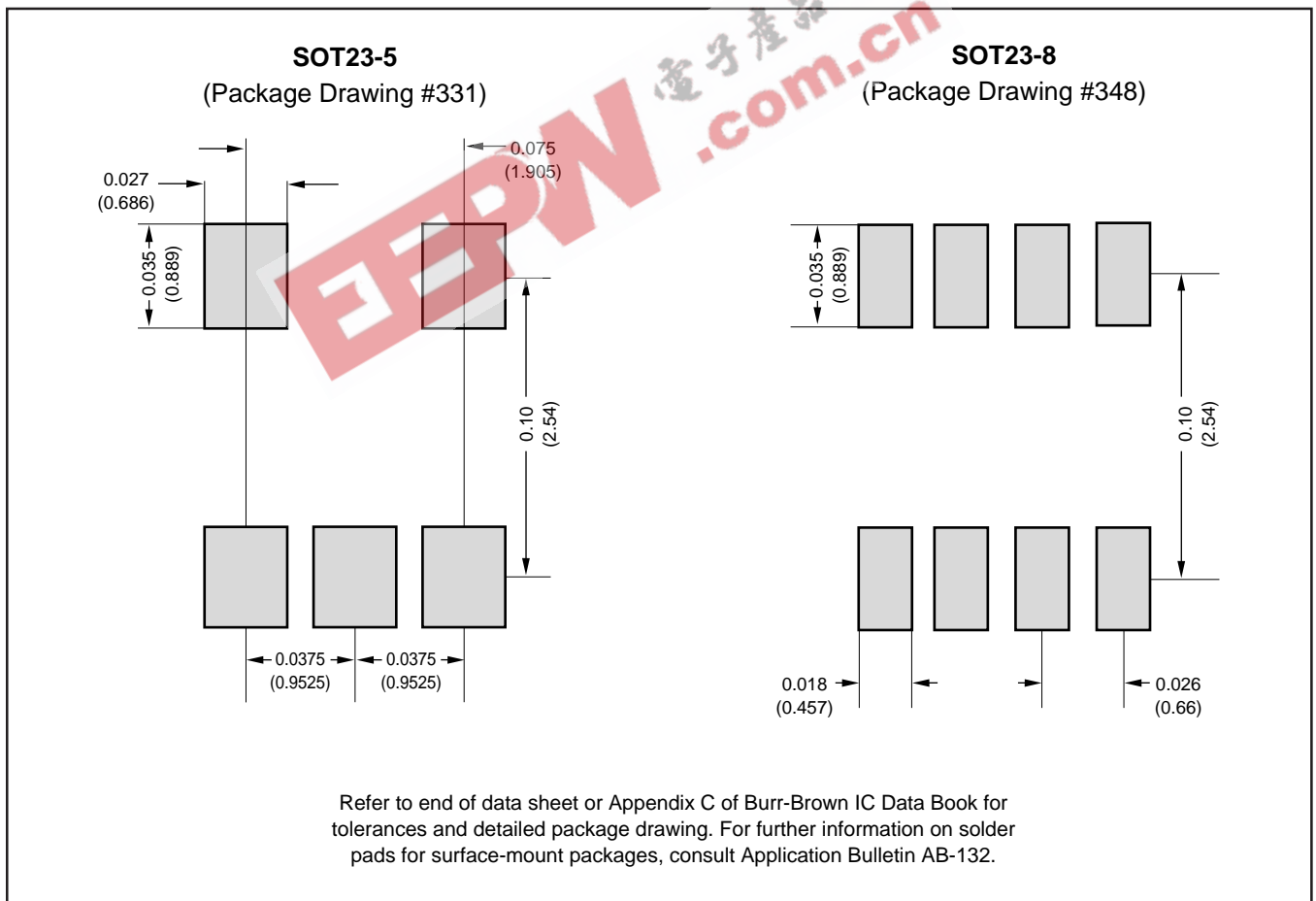

FIGURE 7. Recommended SOT23-5 and SOT23-8 Solder Footprints.