

**OPA134
OPA2134
OPA4134**

SoundPLUS™ High Performance AUDIO OPERATIONAL AMPLIFIERS

FEATURES

- SUPERIOR SOUND QUALITY
- ULTRA LOW DISTORTION: 0.00008%
- LOW NOISE: $8\text{nV}/\sqrt{\text{Hz}}$
- TRUE FET-INPUT: $I_B = 5\text{pA}$
- HIGH SPEED:
 - SLEW RATE: $20\text{V}/\mu\text{s}$
 - BANDWIDTH: 8MHz
- HIGH OPEN-LOOP GAIN: 120dB (600Ω)
- WIDE SUPPLY RANGE: $\pm 2.5\text{V}$ to $\pm 18\text{V}$
- SINGLE, DUAL, AND QUAD VERSIONS

APPLICATIONS

- PROFESSIONAL AUDIO AND MUSIC
- LINE DRIVERS
- LINE RECEIVERS
- MULTIMEDIA AUDIO
- ACTIVE FILTERS
- PREAMPLIFIERS
- INTEGRATORS
- CROSSOVER NETWORKS

DESCRIPTION

The OPA134 series are ultra-low distortion, low noise operational amplifiers fully specified for audio applications. A true FET input stage was incorporated to provide superior sound quality and speed for exceptional audio performance. This in combination with high output drive capability and excellent dc performance allows use in a wide variety of demanding applications. In addition, the OPA134's wide output swing, to within 1V of the rails, allows increased headroom making it ideal for use in any audio circuit.

OPA134 op amps are easy to use and free from phase inversion and overload problems often found in common FET-input op amps. They can be operated from $\pm 2.5\text{V}$ to $\pm 18\text{V}$ power supplies. Input cascode circuitry provides excellent common-mode rejection and maintains low input bias current over its wide input voltage range, minimizing distortion. OPA134 series op amps are unity-gain stable and provide excellent dynamic behavior over a wide range of load conditions, including high load capacitance. The dual and quad versions feature completely independent circuitry for lowest crosstalk and freedom from interaction, even when overdriven or overloaded.

Single and dual versions are available in 8-pin DIP and SO-8 surface-mount packages in standard configurations. The quad is available in 14-pin DIP and SO-14 surface mount packages. All are specified for -40°C to $+85^\circ\text{C}$ operation. A SPICE macromodel is available for design analysis.

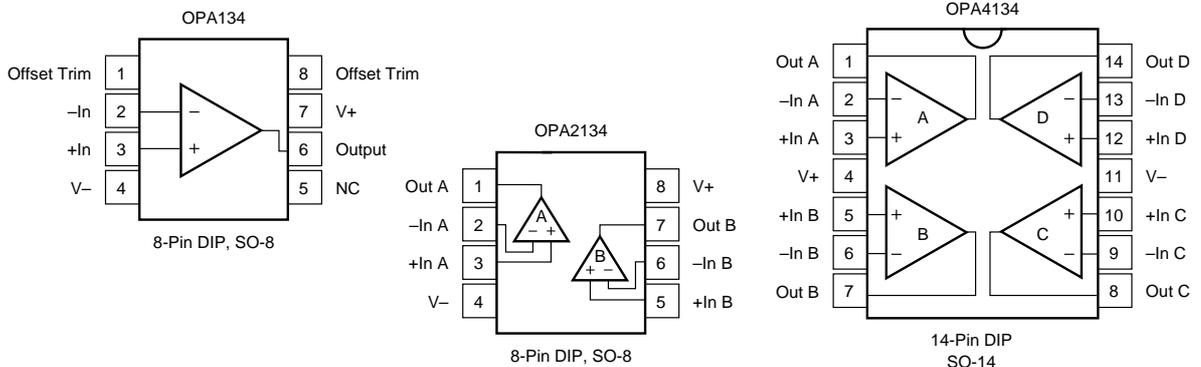

International Airport Industrial Park • Mailing Address: PO Box 11400, Tucson, AZ 85734 • Street Address: 6730 S. Tucson Blvd., Tucson, AZ 85706 • Tel: (520) 746-1111 • Twx: 910-952-1111
Internet: <http://www.burr-brown.com/> • FAXLine: (800) 548-6133 (US/Canada Only) • Cable: BBRCORP • Telex: 066-6491 • FAX: (520) 889-1510 • Immediate Product Info: (800) 548-6132

SPECIFICATIONS

At $T_A = +25^\circ\text{C}$, $V_S = \pm 15\text{V}$, unless otherwise noted.

PARAMETER	CONDITION	OPA134PA, UA OPA2134PA, UA OPA4134PA, UA			UNITS
		MIN	TYP	MAX	
AUDIO PERFORMANCE					
Total Harmonic Distortion + Noise	$G = 1, f = 1\text{kHz}, V_O = 3\text{Vrms}$ $R_L = 2\text{k}\Omega$ $R_L = 600\Omega$		0.00008 0.00015		% %
Intermodulation Distortion Headroom ⁽¹⁾	$G = 1, f = 1\text{kHz}, V_O = 1\text{Vp-p}$ THD < 0.01%, $R_L = 2\text{k}\Omega, V_S = \pm 18\text{V}$		-98 23.6		dB dBu
FREQUENCY RESPONSE					
Gain-Bandwidth Product		± 15	8		MHz
Slew Rate ⁽²⁾			± 20		V/ μs
Full Power Bandwidth			1.3		MHz
Settling Time 0.1%	$G = 1, 10\text{V Step}, C_L = 100\text{pF}$		0.7		μs
0.01%	$G = 1, 10\text{V Step}, C_L = 100\text{pF}$		1		μs
Overload Recovery Time	$(V_{IN}) \cdot (\text{Gain}) = V_S$		0.5		μs
NOISE					
Input Voltage Noise					
Noise Voltage, $f = 20\text{Hz to } 20\text{kHz}$			1.2		μVrms
Noise Density, $f = 1\text{kHz}$			8		nV/ $\sqrt{\text{Hz}}$
Current Noise Density, $f = 1\text{kHz}$			3		fA/ $\sqrt{\text{Hz}}$
OFFSET VOLTAGE					
Input Offset Voltage			± 0.5	± 2	mV
vs Temperature	$T_A = -40^\circ\text{C to } +85^\circ\text{C}$		± 1	$\pm 3^{(3)}$	mV
vs Power Supply (PSRR)	$T_A = -40^\circ\text{C to } +85^\circ\text{C}$		± 2		$\mu\text{V}/^\circ\text{C}$
Channel Separation (Dual, Quad)	$V_S = \pm 2.5\text{V to } \pm 18\text{V}$ dc, $R_L = 2\text{k}\Omega$ $f = 20\text{kHz}, R_L = 2\text{k}\Omega$	90	106 135 130		dB dB dB
INPUT BIAS CURRENT					
Input Bias Current ⁽⁴⁾	$V_{CM} = 0\text{V}$		+5	± 100	pA
vs Temperature ⁽³⁾			See Typical Curve	± 5	nA
Input Offset Current ⁽⁴⁾	$V_{CM} = 0\text{V}$		± 2	± 50	pA
INPUT VOLTAGE RANGE					
Common-Mode Voltage Range	$V_{CM} = -12.5\text{V to } +12.5\text{V}$	(V-)+2.5	± 13	(V+)-2.5	V
Common-Mode Rejection	$T_A = -40^\circ\text{C to } +85^\circ\text{C}$	86	100 90		dB dB
INPUT IMPEDANCE					
Differential			$10^{13} \parallel 2$		$\Omega \parallel \text{pF}$
Common-Mode	$V_{CM} = -12.5\text{V to } +12.5\text{V}$		$10^{13} \parallel 5$		$\Omega \parallel \text{pF}$
OPEN-LOOP GAIN					
Open-Loop Voltage Gain	$R_L = 10\text{k}\Omega, V_O = -14.5\text{V to } +13.8\text{V}$ $R_L = 2\text{k}\Omega, V_O = -13.8\text{V to } +13.5\text{V}$ $R_L = 600\Omega, V_O = -12.8\text{V to } +12.5\text{V}$	104 104 104	120 120 120		dB dB dB
OUTPUT					
Voltage Output	$R_L = 10\text{k}\Omega$ $R_L = 2\text{k}\Omega$ $R_L = 600\Omega$	(V-)+0.5 (V-)+1.2 (V-)+2.2		(V+)-1.2 (V+)-1.5 (V+)-2.5	V V V
Output Current			± 35		mA
Output Impedance, Closed-Loop ⁽⁵⁾	$f = 10\text{kHz}$		0.01		Ω
Open-Loop	$f = 10\text{kHz}$		10		Ω
Short-Circuit Current			± 40		mA
Capacitive Load Drive (Stable Operation)			See Typical Curve		
POWER SUPPLY					
Specified Operating Voltage			± 15		V
Operating Voltage Range		± 2.5		± 18	V
Quiescent Current (per amplifier)	$I_O = 0$		4	5	mA
TEMPERATURE RANGE					
Specified Range		-40		+85	$^\circ\text{C}$
Operating Range		-55		+125	$^\circ\text{C}$
Storage		-55		+125	$^\circ\text{C}$
Thermal Resistance, θ_{JA}					
8-Pin DIP			100		$^\circ\text{C}/\text{W}$
SO-8 Surface-Mount			150		$^\circ\text{C}/\text{W}$
14-Pin DIP			80		$^\circ\text{C}/\text{W}$
SO-14 Surface-Mount			110		$^\circ\text{C}/\text{W}$

NOTES: (1) $\text{dBu} = 20 \cdot \log(\text{Vrms}/0.7746)$ where Vrms is the maximum output voltage for which THD+Noise is less than 0.01%. See THD+Noise text. (2) Guaranteed by design. (3) Guaranteed by wafer-level test to 95% confidence level. (4) High-speed test at $T_J = 25^\circ\text{C}$. (5) See "Closed-Loop Output Impedance vs Frequency" typical curve.



ABSOLUTE MAXIMUM RATINGS⁽¹⁾

Supply Voltage, V+ to V-	36V
Input Voltage	(V-) -0.7V to (V+) +0.7V
Output Short-Circuit ⁽²⁾	Continuous
Operating Temperature	-40°C to +125°C
Storage Temperature	-55°C to +125°C
Junction Temperature	150°C
Lead Temperature (soldering, 10s)	300°C

NOTES: (1) Stresses above these ratings may cause permanent damage.
 (2) Short-circuit to ground, one amplifier per package.

PACKAGE/ORDERING INFORMATION

PRODUCT	PACKAGE	PACKAGE DRAWING NUMBER ⁽¹⁾	TEMPERATURE RANGE
Single			
OPA134PA	8-Pin Plastic DIP	006	-40°C to +85°C
OPA134UA	SO-8 Surface-Mount	182	-40°C to +85°C
Dual			
OPA2134PA	8-Pin Plastic DIP	006	-40°C to +85°C
OPA2134UA	SO-8 Surface-Mount	182	-40°C to +85°C
Quad			
OPA4134PA	14-Pin Plastic DIP	010	-40°C to +85°C
OPA4134UA	SO-14 Surface-Mount	235	-40°C to +85°C

NOTE: (1) For detailed drawing and dimension table, please see end of data sheet, or Appendix C of Burr-Brown IC Data Book.



ELECTROSTATIC DISCHARGE SENSITIVITY

This integrated circuit can be damaged by ESD. Burr-Brown recommends that all integrated circuits be handled with appropriate precautions. Failure to observe proper handling and installation procedures can cause damage.

ESD damage can range from subtle performance degradation to complete device failure. Precision integrated circuits may be more susceptible to damage because very small parametric changes could cause the device not to meet its published specifications.

TYPICAL PERFORMANCE CURVES

At $T_A = +25^\circ\text{C}$, $V_S = \pm 15\text{V}$, $R_L = 2\text{k}\Omega$, unless otherwise noted.

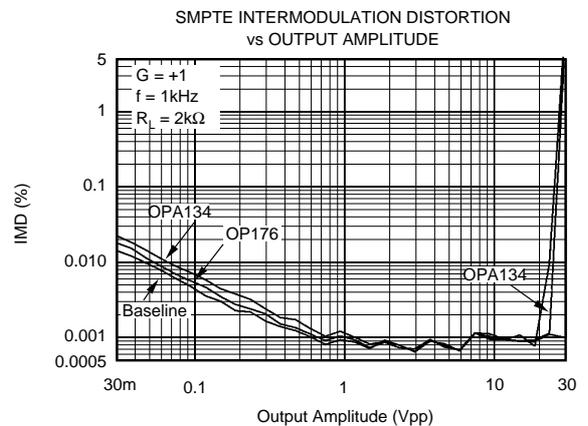
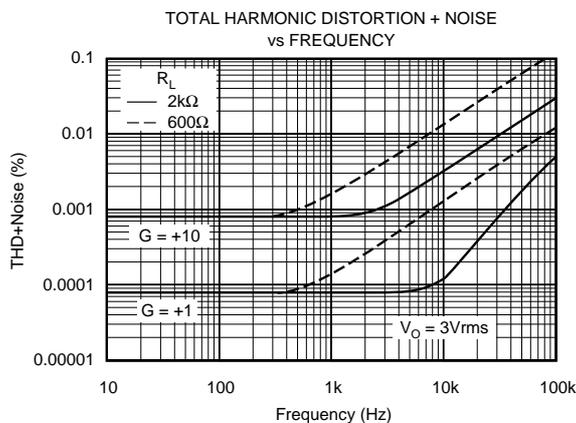

The information provided herein is believed to be reliable; however, BURR-BROWN assumes no responsibility for inaccuracies or omissions. BURR-BROWN assumes no responsibility for the use of this information, and all use of such information shall be entirely at the user's own risk. Prices and specifications are subject to change without notice. No patent rights or licenses to any of the circuits described herein are implied or granted to any third party. BURR-BROWN does not authorize or warrant any BURR-BROWN product for use in life support devices and/or systems.

TYPICAL PERFORMANCE CURVES (CONT)

At $T_A = +25^\circ\text{C}$, $V_S = \pm 15\text{V}$, $R_L = 2\text{k}\Omega$, unless otherwise noted.

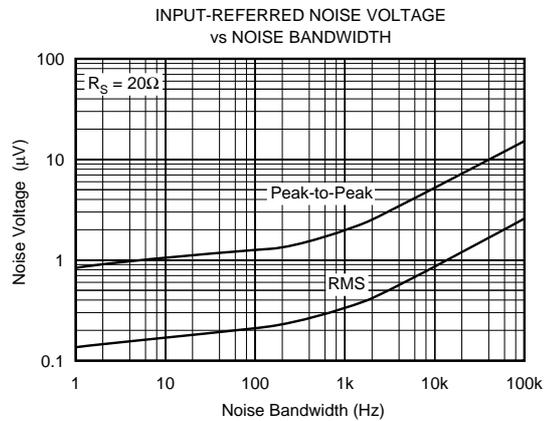
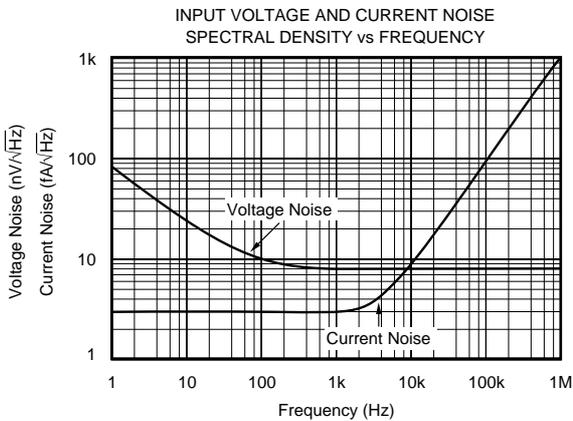
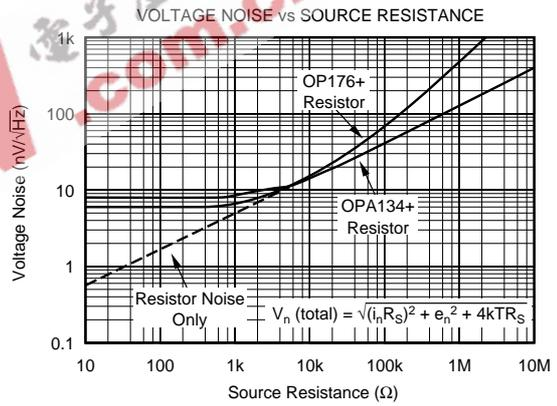
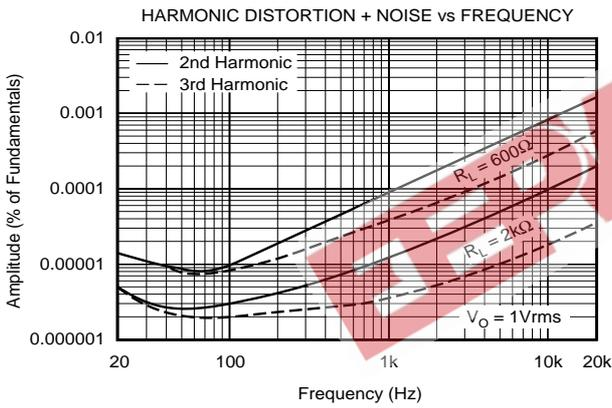
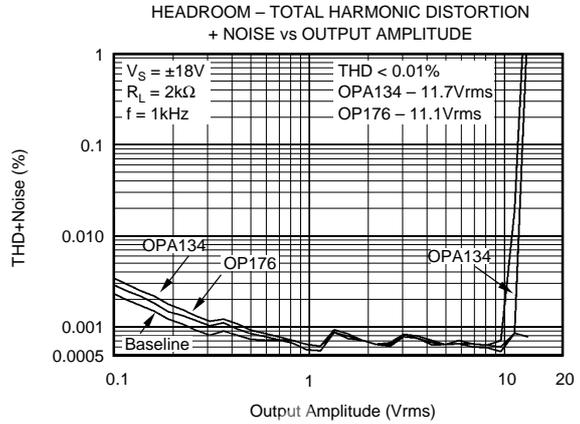
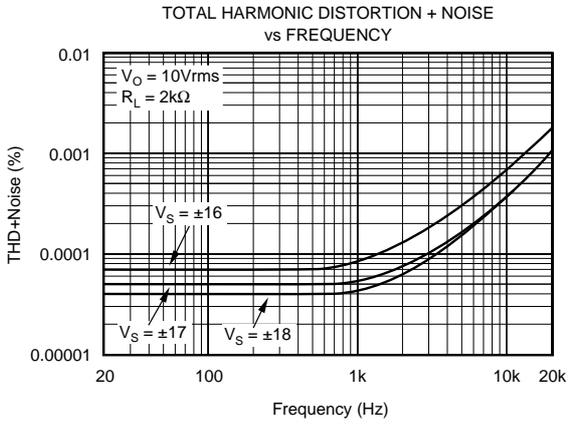

TYPICAL PERFORMANCE CURVES (CONT)

At $T_A = +25^\circ\text{C}$, $V_S = \pm 15\text{V}$, $R_L = 2\text{k}\Omega$, unless otherwise noted.

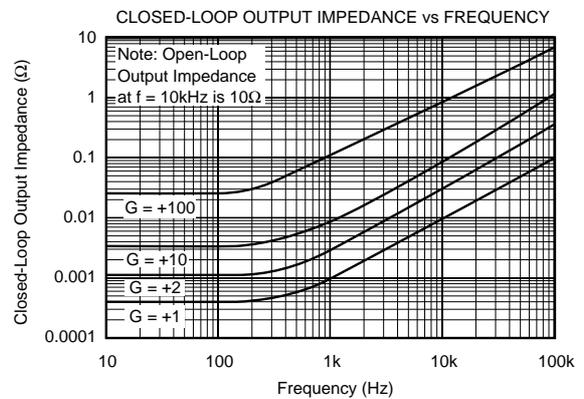
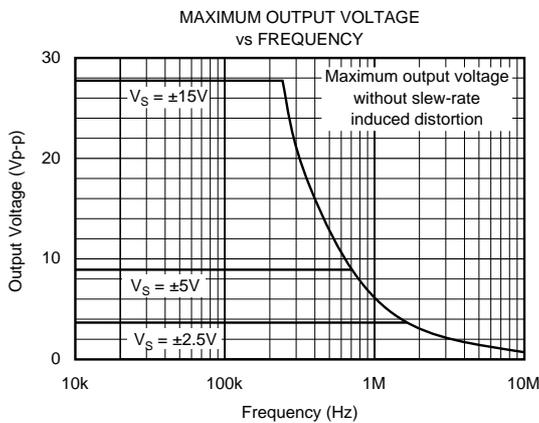
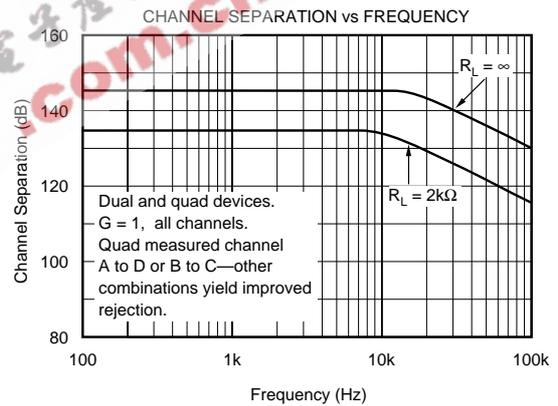
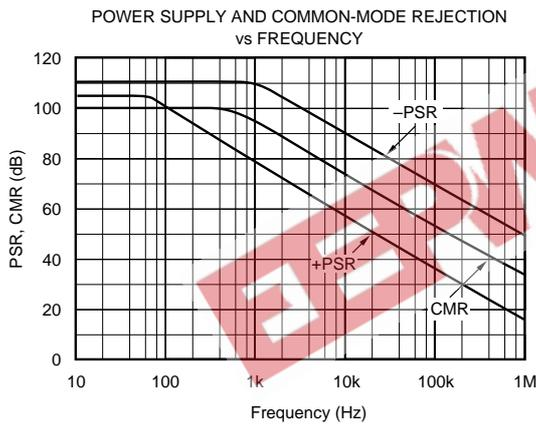
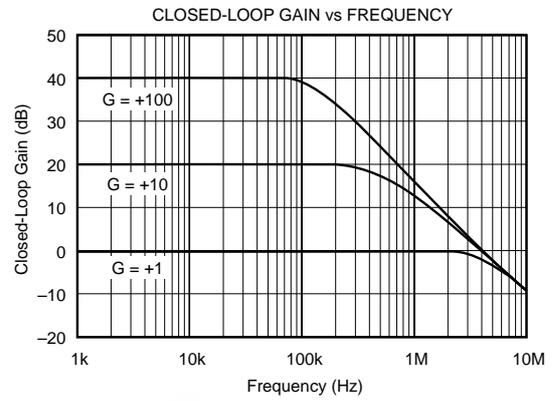
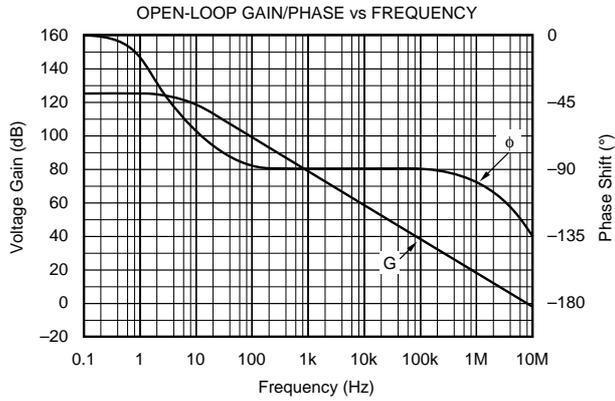

TYPICAL PERFORMANCE CURVES (CONT)

At $T_A = +25^\circ\text{C}$, $V_S = \pm 15\text{V}$, $R_L = 2\text{k}\Omega$, unless otherwise noted.

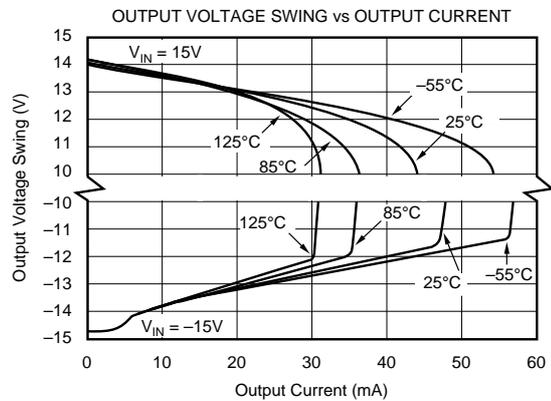
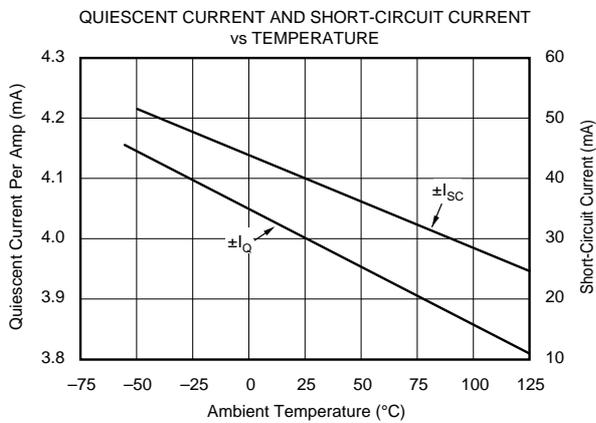
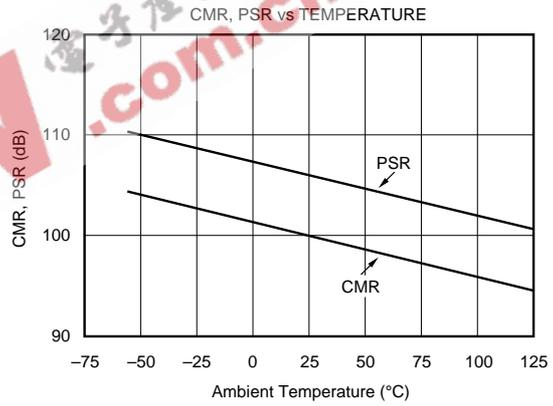
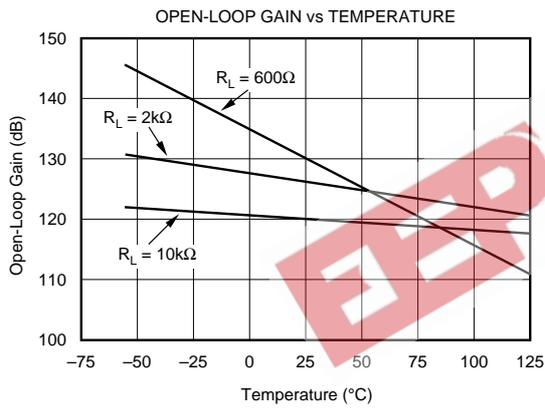
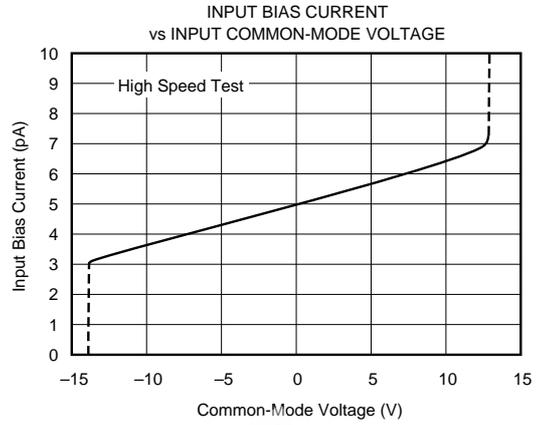
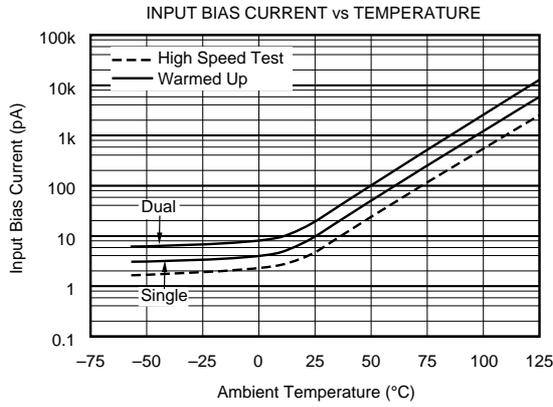

TYPICAL PERFORMANCE CURVES (CONT)

At $T_A = +25^\circ\text{C}$, $V_S = \pm 15\text{V}$, $R_L = 2\text{k}\Omega$, unless otherwise noted.

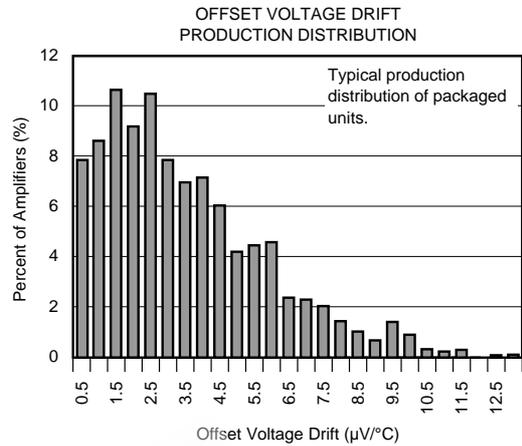
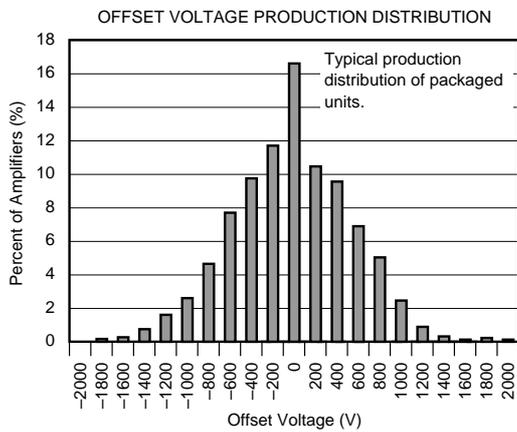

SMALL-SIGNAL STEP RESPONSE
 $G = 1$, $C_L = 100\text{pF}$

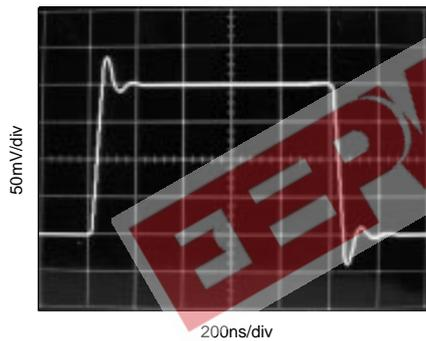

LARGE-SIGNAL STEP RESPONSE
 $G = 1$, $C_L = 100\text{pF}$

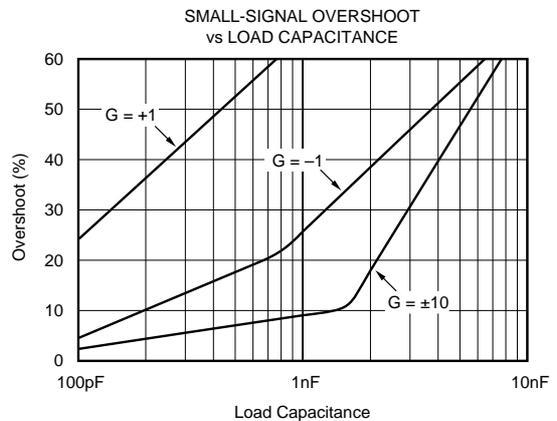
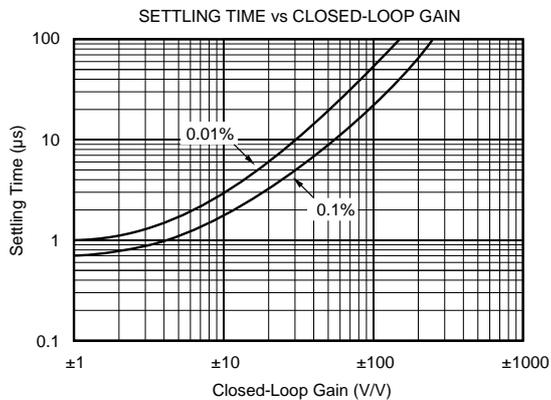
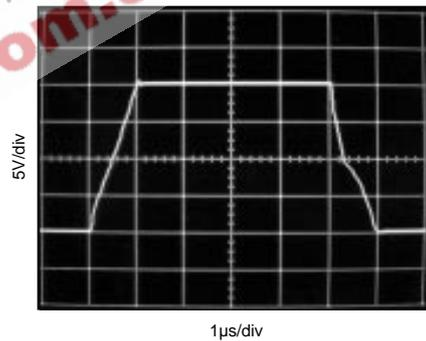

APPLICATIONS INFORMATION

OPA134 series op amps are unity-gain stable and suitable for a wide range of audio and general-purpose applications. All circuitry is completely independent in the dual version, assuring normal behavior when one amplifier in a package is overdriven or short-circuited. Power supply pins should be bypassed with 10nF ceramic capacitors or larger to minimize power supply noise.

OPERATING VOLTAGE

OPA134 series op amps operate with power supplies from $\pm 2.5V$ to $\pm 18V$ with excellent performance. Although specifications are production tested with $\pm 15V$ supplies, most behavior remains unchanged throughout the full operating voltage range. Parameters which vary significantly with operating voltage are shown in the typical performance curves.

OFFSET VOLTAGE TRIM

Offset voltage of OPA134 series amplifiers is laser trimmed and usually requires no user adjustment. The OPA134 (single op amp version) provides offset trim connections on pins 1 and 8, identical to 5534 amplifiers. Offset voltage can be adjusted by connecting a potentiometer as shown in Figure 1. This adjustment should be used only to null the offset of the op amp, not to adjust system offset or offset produced by the signal source. Nulling offset could change the offset voltage drift behavior of the op amp. While it is not possible to predict the exact change in drift, the effect is usually small.

TOTAL HARMONIC DISTORTION

OPA134 series op amps have excellent distortion characteristics. THD+Noise is below 0.0004% throughout the audio frequency range, 20Hz to 20kHz, with a 2k Ω load. In addition, distortion remains relatively flat through its wide output voltage swing range, providing increased headroom compared to other audio amplifiers, including the OP176/275.

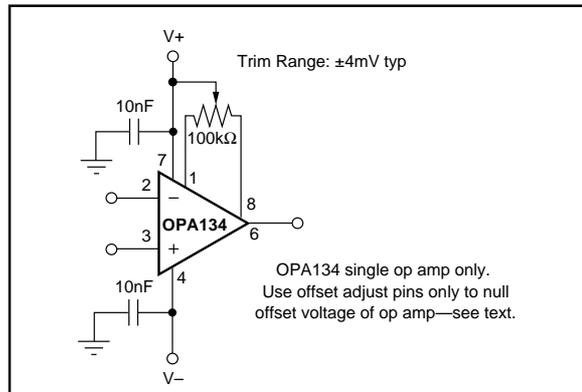

FIGURE 1. OPA134 Offset Voltage Trim Circuit.

In many ways headroom is a subjective measurement. It can be thought of as the maximum output amplitude allowed while still maintaining a very low level of distortion. In an attempt to quantify headroom, we have defined “very low distortion” as 0.01%. Headroom is expressed as a ratio which compares the maximum allowable output voltage level to a standard output level (1mW into 600 Ω , or 0.7746Vrms). Therefore, OPA134 series op amps, which have a maximum allowable output voltage level of 11.7Vrms (THD+Noise < 0.01%), have a headroom specification of 23.6dBu. See the typical curve “Headroom - Total Harmonic Distortion + Noise vs Output Amplitude.”

DISTORTION MEASUREMENTS

The distortion produced by OPA134 series op amps is below the measurement limit of all known commercially available equipment. However, a special test circuit can be used to extend the measurement capabilities.

Op amp distortion can be considered an internal error source which can be referred to the input. Figure 2 shows a circuit which causes the op amp distortion to be 101 times greater than normally produced by the op amp. The addition of R_3 to the otherwise standard non-inverting amplifier

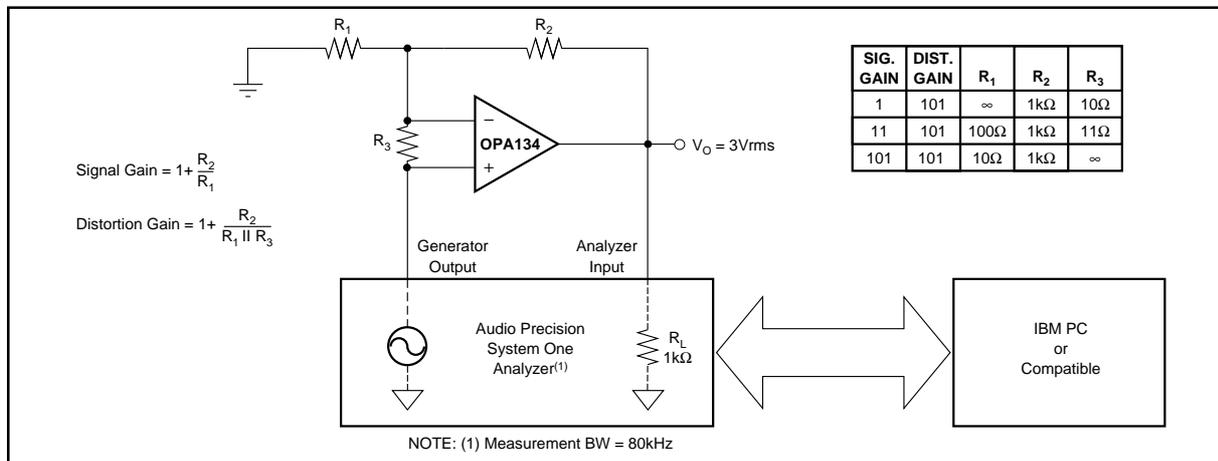

FIGURE 2. Distortion Test Circuit.

configuration alters the feedback factor or noise gain of the circuit. The closed-loop gain is unchanged, but the feedback available for error correction is reduced by a factor of 101, thus extending the resolution by 101. Note that the input signal and load applied to the op amp are the same as with conventional feedback without R_3 . The value of R_3 should be kept small to minimize its effect on the distortion measurements.

Validity of this technique can be verified by duplicating measurements at high gain and/or high frequency where the distortion is within the measurement capability of the test equipment. Measurements for this data sheet were made with an Audio Precision distortion/noise analyzer which greatly simplifies such repetitive measurements. The measurement technique can, however, be performed with manual distortion measurement instruments.

SOURCE IMPEDANCE AND DISTORTION

For lowest distortion with a source or feedback network which has an impedance greater than $2k\Omega$, the impedance seen by the positive and negative inputs in noninverting applications should be matched. The p-channel JFETs in the FET input stage exhibit a varying input capacitance with applied common-mode input voltage. In inverting configurations the input does not vary with input voltage since the inverting input is held at virtual ground. However, in noninverting applications the inputs do vary, and the gate-to-source voltage is not constant. The effect is increased distortion due to the varying capacitance for unmatched source impedances greater than $2k\Omega$.

To maintain low distortion, match unbalanced source impedance with appropriate values in the feedback network as shown in Figure 3. Of course, the unbalanced impedance may be from gain-setting resistors in the feedback path. If the parallel combination of R_1 and R_2 is greater than $2k\Omega$, a matching impedance on the noninverting input should be used. As always, resistor values should be minimized to reduce the effects of thermal noise.

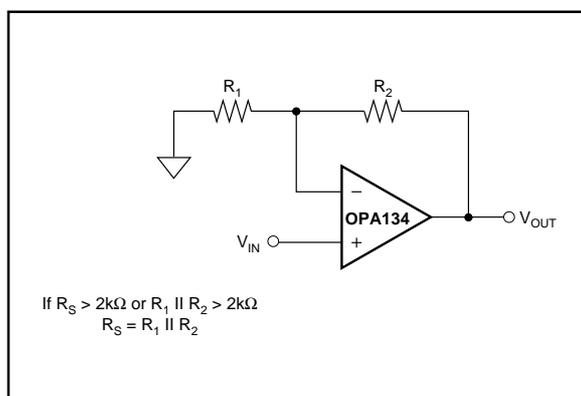

FIGURE 3. Impedance Matching for Maintaining Low Distortion in Non-Inverting Circuits.

NOISE PERFORMANCE

Circuit noise is determined by the thermal noise of external resistors and op amp noise. Op amp noise is described by two parameters—noise voltage and noise current. The total noise is quantified by the equation:

$$V_n(\text{total}) = \sqrt{(i_n R_S)^2 + e_n^2 + 4kTR_s}$$

With low source impedance, the current noise term is insignificant and voltage noise dominates the noise performance. At high source impedance, the current noise term becomes the dominant contributor.

Low noise bipolar op amps such as the OPA27 and OPA37 provide very low voltage noise at the expense of a higher current noise. However, OPA134 series op amps are unique in providing very low voltage noise and very low current noise. This provides optimum noise performance over a wide range of sources, including reactive source impedances, refer to the typical curve, “Voltage Noise vs Source Resistance.” Above $2k\Omega$ source resistance, the op amp contributes little additional noise—the voltage and current terms in the total noise equation become insignificant and the source resistance term dominates. Below $2k\Omega$, op amp voltage noise dominates over the resistor noise, but compares favorably with other audio op amps such as OP176.

PHASE REVERSAL PROTECTION

OPA134 series op amps are free from output phase-reversal problems. Many audio op amps, such as OP176, exhibit phase-reversal of the output when the input common-mode voltage range is exceeded. This can occur in voltage-follower circuits, causing serious problems in control loop applications. OPA134 series op amps are free from this undesirable behavior even with inputs of 10V beyond the input common-mode range.

POWER DISSIPATION

OPA134 series op amps are capable of driving 600Ω loads with power supply voltage up to $\pm 18V$. Internal power dissipation is increased when operating at high supply voltages. Copper leadframe construction used in OPA134 series op amps improves heat dissipation compared to conventional materials. Circuit board layout can also help minimize junction temperature rise. Wide copper traces help dissipate the heat by acting as an additional heat sink. Temperature rise can be further minimized by soldering the devices to the circuit board rather than using a socket.

OUTPUT CURRENT LIMIT

Output current is limited by internal circuitry to approximately $\pm 40mA$ at $25^\circ C$. The limit current decreases with increasing temperature as shown in the typical performance curve “Short-Circuit Current vs Temperature.”

PACKAGING INFORMATION

Orderable Device	Status ⁽¹⁾	Package Type	Package Drawing	Pins	Package Qty	Eco Plan ⁽²⁾	Lead/Ball Finish	MSL Peak Temp ⁽³⁾
OPA134PA	ACTIVE	PDIP	P	8	50	Green (RoHS & no Sb/Br)	CU NIPDAU	N / A for Pkg Type
OPA134PA3	OBSOLETE	PDIP	P	8		TBD	Call TI	Call TI
OPA134PAG4	ACTIVE	PDIP	P	8	50	Green (RoHS & no Sb/Br)	CU NIPDAU	N / A for Pkg Type
OPA134UA	ACTIVE	SOIC	D	8	100	Green (RoHS & no Sb/Br)	CU NIPDAU	Level-3-260C-168 HR
OPA134UA/2K5	ACTIVE	SOIC	D	8	2500	Pb-Free (RoHS)	CU NIPDAU	Level-3-260C-168 HR
OPA134UA/2K5E4	ACTIVE	SOIC	D	8	2500	Pb-Free (RoHS)	CU NIPDAU	Level-3-260C-168 HR
OPA134UA3	OBSOLETE	PDIP	P	8		TBD	Call TI	Call TI
OPA134UAE4	ACTIVE	SOIC	D	8	100	Green (RoHS & no Sb/Br)	CU NIPDAU	Level-3-260C-168 HR
OPA134UAG4	ACTIVE	SOIC	D	8	100	Green (RoHS & no Sb/Br)	CU NIPDAU	Level-3-260C-168 HR
OPA2134PA	ACTIVE	PDIP	P	8	50	Green (RoHS & no Sb/Br)	CU NIPDAU	N / A for Pkg Type
OPA2134PAG4	ACTIVE	PDIP	P	8	50	Green (RoHS & no Sb/Br)	CU NIPDAU	N / A for Pkg Type
OPA2134UA	ACTIVE	SOIC	D	8	100	Green (RoHS & no Sb/Br)	CU NIPDAU	Level-3-260C-168 HR
OPA2134UA/2K5	ACTIVE	SOIC	D	8	2500	Green (RoHS & no Sb/Br)	CU NIPDAU	Level-3-260C-168 HR
OPA2134UA/2K5E4	ACTIVE	SOIC	D	8	2500	Pb-Free (RoHS)	CU NIPDAU	Level-3-260C-168 HR
OPA2134UAE4	ACTIVE	SOIC	D	8	100	Pb-Free (RoHS)	CU NIPDAU	Level-3-260C-168 HR
OPA2134UAG4	ACTIVE	SOIC	D	8	100	Green (RoHS & no Sb/Br)	CU NIPDAU	Level-3-260C-168 HR
OPA4134PA	OBSOLETE	PDIP	N	14		TBD	Call TI	Call TI
OPA4134UA	ACTIVE	SOIC	D	14	58	Pb-Free (RoHS)	CU NIPDAU	Level-3-260C-168 HR
OPA4134UA/2K5	ACTIVE	SOIC	D	14	2500	Pb-Free (RoHS)	CU NIPDAU	Level-3-260C-168 HR
OPA4134UA/2K5E4	ACTIVE	SOIC	D	14	2500	Pb-Free (RoHS)	CU NIPDAU	Level-3-260C-168 HR
OPA4134UAE4	ACTIVE	SOIC	D	14	58	Pb-Free (RoHS)	CU NIPDAU	Level-3-260C-168 HR
SN412008DRE4	ACTIVE	SOIC	D	8	2500	Pb-Free (RoHS)	CU NIPDAU	Level-3-260C-168 HR

⁽¹⁾ The marketing status values are defined as follows:

ACTIVE: Product device recommended for new designs.

LIFEBUY: TI has announced that the device will be discontinued, and a lifetime-buy period is in effect.

NRND: Not recommended for new designs. Device is in production to support existing customers, but TI does not recommend using this part in a new design.

PREVIEW: Device has been announced but is not in production. Samples may or may not be available.

OBSOLETE: TI has discontinued the production of the device.

⁽²⁾ Eco Plan - The planned eco-friendly classification: Pb-Free (RoHS), Pb-Free (RoHS Exempt), or Green (RoHS & no Sb/Br) - please check <http://www.ti.com/productcontent> for the latest availability information and additional product content details.

TBD: The Pb-Free/Green conversion plan has not been defined.

Pb-Free (RoHS): TI's terms "Lead-Free" or "Pb-Free" mean semiconductor products that are compatible with the current RoHS requirements for all 6 substances, including the requirement that lead not exceed 0.1% by weight in homogeneous materials. Where designed to be soldered at high temperatures, TI Pb-Free products are suitable for use in specified lead-free processes.

Pb-Free (RoHS Exempt): This component has a RoHS exemption for either 1) lead-based flip-chip solder bumps used between the die and package, or 2) lead-based die adhesive used between the die and leadframe. The component is otherwise considered Pb-Free (RoHS compatible) as defined above.

Green (RoHS & no Sb/Br): TI defines "Green" to mean Pb-Free (RoHS compatible), and free of Bromine (Br) and Antimony (Sb) based flame retardants (Br or Sb do not exceed 0.1% by weight in homogeneous material)

⁽³⁾ MSL, Peak Temp. -- The Moisture Sensitivity Level rating according to the JEDEC industry standard classifications, and peak solder temperature.

Important Information and Disclaimer:The information provided on this page represents TI's knowledge and belief as of the date that it is provided. TI bases its knowledge and belief on information provided by third parties, and makes no representation or warranty as to the accuracy of such information. Efforts are underway to better integrate information from third parties. TI has taken and continues to take reasonable steps to provide representative and accurate information but may not have conducted destructive testing or chemical analysis on incoming materials and chemicals. TI and TI suppliers consider certain information to be proprietary, and thus CAS numbers and other limited information may not be available for release.

In no event shall TI's liability arising out of such information exceed the total purchase price of the TI part(s) at issue in this document sold by TI to Customer on an annual basis.



IMPORTANT NOTICE

Texas Instruments Incorporated and its subsidiaries (TI) reserve the right to make corrections, modifications, enhancements, improvements, and other changes to its products and services at any time and to discontinue any product or service without notice. Customers should obtain the latest relevant information before placing orders and should verify that such information is current and complete. All products are sold subject to TI's terms and conditions of sale supplied at the time of order acknowledgment.

TI warrants performance of its hardware products to the specifications applicable at the time of sale in accordance with TI's standard warranty. Testing and other quality control techniques are used to the extent TI deems necessary to support this warranty. Except where mandated by government requirements, testing of all parameters of each product is not necessarily performed.

TI assumes no liability for applications assistance or customer product design. Customers are responsible for their products and applications using TI components. To minimize the risks associated with customer products and applications, customers should provide adequate design and operating safeguards.

TI does not warrant or represent that any license, either express or implied, is granted under any TI patent right, copyright, mask work right, or other TI intellectual property right relating to any combination, machine, or process in which TI products or services are used. Information published by TI regarding third-party products or services does not constitute a license from TI to use such products or services or a warranty or endorsement thereof. Use of such information may require a license from a third party under the patents or other intellectual property of the third party, or a license from TI under the patents or other intellectual property of TI.

Reproduction of information in TI data books or data sheets is permissible only if reproduction is without alteration and is accompanied by all associated warranties, conditions, limitations, and notices. Reproduction of this information with alteration is an unfair and deceptive business practice. TI is not responsible or liable for such altered documentation.

Resale of TI products or services with statements different from or beyond the parameters stated by TI for that product or service voids all express and any implied warranties for the associated TI product or service and is an unfair and deceptive business practice. TI is not responsible or liable for any such statements.

Following are URLs where you can obtain information on other Texas Instruments products and application solutions:

Products		Applications	
Amplifiers	amplifier.ti.com	Audio	www.ti.com/audio
Data Converters	dataconverter.ti.com	Automotive	www.ti.com/automotive
DSP	dsp.ti.com	Broadband	www.ti.com/broadband
Interface	interface.ti.com	Digital Control	www.ti.com/digitalcontrol
Logic	logic.ti.com	Military	www.ti.com/military
Power Mgmt	power.ti.com	Optical Networking	www.ti.com/opticalnetwork
Microcontrollers	microcontroller.ti.com	Security	www.ti.com/security
Low Power Wireless	www.ti.com/lpw	Telephony	www.ti.com/telephony
		Video & Imaging	www.ti.com/video
		Wireless	www.ti.com/wireless

Mailing Address: Texas Instruments
Post Office Box 655303 Dallas, Texas 75265