

OPA344
OPA2344
OPA4344
OPA345
OPA2345
OPA4345

For most current data sheet and other product information, visit www.burr-brown.com

LOW POWER, SINGLE-SUPPLY, RAIL-TO-RAIL OPERATIONAL AMPLIFIERS

MicroAmplifier™ Series

FEATURES

- RAIL-TO-RAIL INPUT
- RAIL-TO-RAIL OUTPUT (within 1mV)
- LOW QUIESCENT CURRENT: 150µA typ
- MicroSIZE PACKAGES
 - SOT23-5
 - MSOP-8
 - TSSOP-14
- GAIN-BANDWIDTH
 - OPA344: 1MHz, G ≥ 1
 - OPA345: 3MHz, G ≥ 5
- SLEW RATE
 - OPA344: 0.8V/µs
 - OPA345: 2V/µs
- THD + NOISE: 0.006%

DESCRIPTION

The OPA344 and OPA345 series rail-to-rail CMOS operational amplifiers are designed for precision, low-power, miniature applications. The OPA344 is unity gain stable, while the OPA345 is optimized for gains greater than or equal to five, and has a gain-bandwidth product of 3MHz.

The OPA344 and OPA345 are optimized to operate on a single supply from 2.5V and up to 5.5V with an input common-mode voltage range that extends 300mV beyond the supplies. Quiescent current is only 250µA (max).

Rail-to-rail input and output make them ideal for driving sampling analog-to-digital converters. They are also well suited for general purpose and audio applications and providing I/V conversion at the output of D/A converters. Single, dual and quad versions have identical specs for design flexibility.

A variety of packages are available. All are specified for operation from -40°C to 85°C. A SPICE macromodel is available for design analysis.

APPLICATIONS

- PCMCIA CARDS
- DATA ACQUISITION
- PROCESS CONTROL
- AUDIO PROCESSING
- COMMUNICATIONS
- ACTIVE FILTERS
- TEST EQUIPMENT

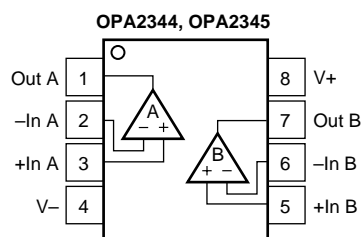

SO-8, MSOP-8, 8-Pin DIP (OPA2344 Only)

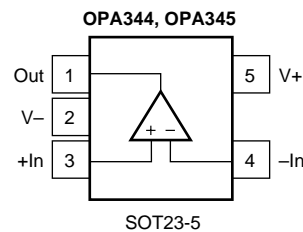

SOT23-5

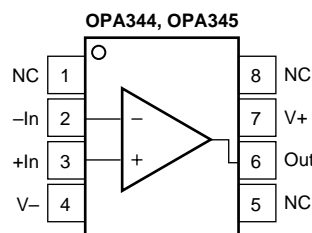

SO-8, 8-Pin DIP (OPA344 Only)

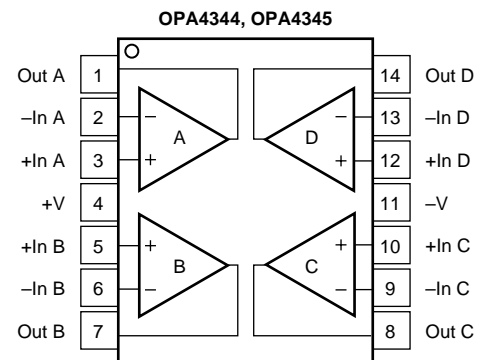

TSSOP-14, SO-14, 14-Pin DIP (OPA4344 Only)

International Airport Industrial Park • Mailing Address: PO Box 11400, Tucson, AZ 85734 • Street Address: 6730 S. Tucson Blvd., Tucson, AZ 85706 • Tel: (520) 746-1111
 Twx: 910-952-1111 • Internet: <http://www.burr-brown.com/> • Cable: BBRCORP • Telex: 066-6491 • FAX: (520) 889-1510 • Immediate Product Info: (800) 548-6132

SPECIFICATIONS: $V_S = 2.7V$ to $5.5V$

At $T_A = +25^\circ C$, $R_L = 10k\Omega$ connected to $V_S/2$ and $V_{OUT} = V_S/2$, unless otherwise noted.
Boldface limits apply over the temperature range, $T_A = -40^\circ C$ to $+85^\circ C$.

PARAMETER	CONDITION	OPA344NA, UA, PA OPA2344EA, UA, PA OPA4344EA, UA, PA			UNITS
		MIN	TYP	MAX	
OFFSET VOLTAGE Input Offset Voltage Over Temperature vs Temperature vs Power Supply Over Temperature Channel Separation, dc $f = 1kHz$	V_{OS} dV_{OS}/dT PSRR $V_S = 2.7V$ to $5.5V$, $V_{CM} < (V+) - 1.8V$ $V_S = 2.7V$ to $5.5V$, $V_{CM} < (V+) - 1.8V$		± 0.2 ± 0.8 ± 3 30 0.2 130	± 1 ± 1.2 200 250	mV mV $\mu V/^\circ C$ $\mu V/V$ $\mu V/V$ $\mu V/V$ dB
INPUT BIAS CURRENT Input Bias Current Over Temperature Input Offset Current	I_B I_{OS}		± 0.2 See Typical Curve ± 0.2	± 10 ± 10	pA pA pA
NOISE Input Voltage Noise Input Voltage Noise Density Current Noise Density	e_n i_n $f = 0.1$ to $50kHz$ $f = 10kHz$ $f = 10kHz$		8 30 0.5		μV_{rms} nV/\sqrt{Hz} fA/\sqrt{Hz}
INPUT VOLTAGE RANGE Common-Mode Voltage Range Common-Mode Rejection Ratio Over Temperature Common-Mode Rejection Over Temperature Common-Mode Rejection Over Temperature	V_{CM} CMRR CMRR CMRR CMRR $V_S = +5.5V$, $-0.3V < V_{CM} < (V+) - 1.8$ $V_S = +5.5V$, $-0.3V < V_{CM} < (V+) - 1.8$ $V_S = +5.5V$, $-0.3V < V_{CM} < 5.8V$ $V_S = +5.5V$, $-0.3V < V_{CM} < 5.8V$ $V_S = +2.7V$, $-0.3V < V_{CM} < 3V$ $V_S = +2.7V$, $-0.3V < V_{CM} < 3V$	-0.3 76 74 70 68 66 64	92 84 80	$(V+) + 0.3$	V dB dB dB dB dB
INPUT IMPEDANCE Differential Common-Mode			$10^{13} \parallel 3$ $10^{13} \parallel 6$		$\Omega \parallel pF$ $\Omega \parallel pF$
OPEN-LOOP GAIN Open-Loop Voltage Gain Over Temperature Over Temperature	A_{OL} $R_L = 100k\Omega$, $10mV < V_O < (V+) - 10mV$ $R_L = 100k\Omega$, $10mV < V_O < (V+) - 10mV$ $R_L = 5k\Omega$, $400mV < V_O < (V+) - 400mV$ $R_L = 5k\Omega$, $400mV < V_O < (V+) - 400mV$	104 100 96 90	122 120		dB dB dB dB
FREQUENCY RESPONSE Gain-Bandwidth Product Slew Rate Settling Time, 0.1% 0.01% Overload Recovery Time Total Harmonic Distortion + Noise	GBW SR THD+N $C_L = 100pF$ $V_S = 5.5V$, 2V Step $V_S = 5.5V$, 2V Step $V_{IN} \cdot G = V_S$ $V_S = 5.5V$, $V_O = 3Vp-p$, $G = 1$, $f = 1kHz$		1 0.8 5 8 2.5 0.006		MHz $V/\mu s$ μs μs μs %
OUTPUT Voltage Output Swing from Rail ⁽¹⁾ Over Temperature Over Temperature Short-Circuit Current Capacitive Load Drive	I_{SC} C_{LOAD} $R_L = 100k\Omega$, $A_{OL} \geq 96dB$ $R_L = 100k\Omega$, $A_{OL} \geq 104dB$ $R_L = 100k\Omega$, $A_{OL} \geq 100dB$ $R_L = 5k\Omega$, $A_{OL} \geq 96dB$ $R_L = 5k\Omega$, $A_{OL} \geq 90dB$		1 3 40 ± 15 See Typical Curve	10 10 400 400	mV mV mV mV mA
POWER SUPPLY Specified Voltage Range Operating Voltage Range Quiescent Current (per amplifier) Over Temperature	V_S I_Q $V_S = 5.5V$, $I_Q = 0$	2.7	2.5 to 5.5 150	5.5 250 300	V V μA μA
TEMPERATURE RANGE Specified Range Operating Range Storage Range Thermal Resistance SOT23-5 Surface Mount MSOP-8 Surface Mount 8-Pin DIP SO-8 Surface Mount TSSOP-14 Surface Mount 14-Pin DIP SO-14 Surface Mount	θ_{JA}	-40 -55 -65		85 125 150	$^\circ C$ $^\circ C$ $^\circ C$ $^\circ C/W$ $^\circ C/W$ $^\circ C/W$ $^\circ C/W$ $^\circ C/W$ $^\circ C/W$ $^\circ C/W$ $^\circ C/W$

NOTE: (1) Output voltage swings are measured between the output and power-supply rails.

SPECIFICATIONS: $V_S = 2.7V$ to $5.5V$

At $T_A = +25^\circ C$, $R_L = 10k\Omega$ connected to $V_S/2$ and $V_{OUT} = V_S/2$, unless otherwise noted.
Boldface limits apply over the temperature range, $T_A = -40^\circ C$ to $+85^\circ C$.

PARAMETER	CONDITION	OPA345NA, UA OPA2345EA, UA OPA4345EA, UA			UNITS
		MIN	TYP	MAX	
OFFSET VOLTAGE Input Offset Voltage Over Temperature vs Temperature vs Power Supply Over Temperature Channel Separation, dc $f = 1kHz$	V_{OS} dV_{OS}/dT PSRR $V_S = 2.7V$ to $5.5V$, $V_{CM} < (V+) - 1.8V$ $V_S = 2.7V$ to $5.5V$, $V_{CM} < (V+) - 1.8V$		± 0.2 ± 0.8 ± 3 30 0.2 130	± 1 ± 1.2 200 250	mV mV $\mu V/^\circ C$ $\mu V/V$ $\mu V/V$ $\mu V/V$ dB
INPUT BIAS CURRENT Input Bias Current Over Temperature Input Offset Current	I_B I_{OS}		± 0.2 See Typical Curve ± 0.2	± 10 ± 10	pA pA pA
NOISE Input Voltage Noise Input Voltage Noise Density Current Noise Density	e_n i_n $f = 0.1$ to $50kHz$ $f = 10kHz$ $f = 10kHz$		8 30 0.5		μV_{rms} nV/\sqrt{Hz} fA/\sqrt{Hz}
INPUT VOLTAGE RANGE Common-Mode Voltage Range Common-Mode Rejection Ratio Over Temperature Common-Mode Rejection Ratio Over Temperature Common-Mode Rejection Ratio Over Temperature	V_{CM} CMRR CMRR CMRR CMRR $V_S = +5.5V$, $-0.3V < V_{CM} < (V+) - 1.8$ $V_S = +5.5V$, $-0.3V < V_{CM} < (V+) - 1.8$ $V_S = +5.5V$, $-0.3V < V_{CM} < 5.8V$ $V_S = +5.5V$, $-0.3V < V_{CM} < 5.8V$ $V_S = +2.7V$, $-0.3V < V_{CM} < 3V$ $V_S = +2.7V$, $-0.3V < V_{CM} < 3V$	-0.3 76 74 70 68 66 64	92 84 80	$(V+) + 0.3$	V dB dB dB dB dB dB
INPUT IMPEDANCE Differential Common-Mode			$10^{13} \parallel 3$ $10^{13} \parallel 6$		$\Omega \parallel pF$ $\Omega \parallel pF$
OPEN-LOOP GAIN Open-Loop Voltage Gain Over Temperature Over Temperature	A_{OL} $R_L = 100k\Omega$, $10mV < V_O < (V+) - 10mV$ $R_L = 100k\Omega$, $10mV < V_O < (V+) - 10mV$ $R_L = 5k\Omega$, $400mV < V_O < (V+) - 400mV$ $R_L = 5k\Omega$, $400mV < V_O < (V+) - 400mV$	104 100 96 90	122 120		dB dB dB dB
FREQUENCY RESPONSE Gain-Bandwidth Product Slew Rate Settling Time, 0.1% 0.01% Overload Recovery Time Total Harmonic Distortion + Noise	GBW SR THD+N $C_L = 100pF$ $G = 5$, 2V Output Step $G = 5$, 2V Output Step $V_{IN} \cdot G = V_S$ $V_S = 5.5V$, $V_O = 2.5V_{p-p}$, $G = 5$, $f = 1kHz$		3 2 1.5 1.6 2.5 0.006		MHz $V/\mu s$ μs μs μs %
OUTPUT Voltage Output Swing from Rail ⁽¹⁾ Over Temperature Over Temperature Short-Circuit Current Capacitive Load Drive	I_{SC} C_{LOAD} $R_L = 100k\Omega$, $A_{OL} \geq 96dB$ $R_L = 100k\Omega$, $A_{OL} \geq 104dB$ $R_L = 100k\Omega$, $A_{OL} \geq 100dB$ $R_L = 5k\Omega$, $A_{OL} \geq 96dB$ $R_L = 5k\Omega$, $A_{OL} \geq 90dB$		1 3 40 ± 15 See Typical Curve	10 10 400 400	mV mV mV mV mA
POWER SUPPLY Specified Voltage Range Operating Voltage Range Quiescent Current (per amplifier) Over Temperature	V_S I_Q $V_S = 5.5V$, $I_Q = 0$	2.7	2.5 to 5.5 150	5.5 250 300	V V μA μA
TEMPERATURE RANGE Specified Range Operating Range Storage Range Thermal Resistance SOT23-5 Surface Mount MSOP-8 Surface Mount SO-8 Surface Mount TSSOP-14 Surface Mount SO-14 Surface Mount	θ_{JA}	-40 -55 -65		85 125 150	$^\circ C$ $^\circ C$ $^\circ C$ $^\circ C/W$ $^\circ C/W$ $^\circ C/W$ $^\circ C/W$ $^\circ C/W$

NOTE: (1) Output voltage swings are measured between the output and power-supply rails.

ABSOLUTE MAXIMUM RATINGS⁽¹⁾

Supply Voltage, V+ to V-	7.5V
Signal Input Terminals, Voltage ⁽²⁾	(V-) -0.5V to (V+) +0.5V
Current ⁽²⁾	10mA
Output Short-Circuit ⁽³⁾	Continuous
Operating Temperature	-55°C to +125°C
Storage Temperature	-65°C to +150°C
Junction Temperature	150°C
Lead Temperature (soldering, 10s)	300°C
ESD Tolerance (Human Body Model)	4000V

NOTES: (1) Stresses above these ratings may cause permanent damage. Exposure to absolute maximum conditions for extended periods may degrade device reliability. These are stress ratings only. Functional operation of the device at these conditions, or beyond the specified operating conditions, is not implied. (2) Input terminals are diode-clamped to the power supply rails. Input signals that can swing more than 0.5V beyond the supply rails should be current-limited to 10mA or less. (3) Short-circuit to ground, one amplifier per package.



ELECTROSTATIC DISCHARGE SENSITIVITY

This integrated circuit can be damaged by ESD. Burr-Brown recommends that all integrated circuits be handled with appropriate precautions. Failure to observe proper handling and installation procedures can cause damage. ESD damage can range from subtle performance degradation to complete device failure. Precision integrated circuits may be more susceptible to damage because very small parametric changes could cause the device not to meet its published specifications.

PACKAGE/ORDERING INFORMATION

PRODUCT	PACKAGE	PACKAGE DRAWING NUMBER	SPECIFIED TEMPERATURE RANGE	PACKAGE MARKING	ORDERING NUMBER ⁽¹⁾	TRANSPORT MEDIA
OPA344NA "	SOT23-5 "	331 "	-40°C to +85°C "	B44 "	OPA344NA/250 OPA344NA/3K	Tape and Reel Tape and Reel
OPA344UA "	SO-8 "	182 "	-40°C to +85°C "	OPA344UA "	OPA344UA OPA344UA/2K5	Rails Tape and Reel
OPA344PA	8-Pin Dip	006	-40°C to +85°C	OPA344PA	OPA344PA	Rails
OPA2344EA "	MSOP-8 "	337 "	-40°C to +85°C "	C44 "	OPA2344EA/250 OPA2344EA/2K5	Tape and Reel Tape and Reel
OPA2344UA "	SO-8 "	182 "	-40°C to +85°C "	OPA2344UA "	OPA2344UA OPA2344UA/2K5	Rails Tape and Reel
OPA2344PA	8-Pin DIP	006	-40°C to +85°C	OPA2344PA	OPA2344PA	Rails
OPA4344EA "	TSSOP-14 "	357 "	-40°C to +85°C "	OPA4344EA "	OPA4344EA/250 OPA4344EA/2K5	Rails Tape and Reel
OPA4344UA "	SO-14 "	235 "	-40°C to +85°C "	OPA4344UA "	OPA4344UA OPA4344UA/2K5	Rails Tape and Reel
OPA4344PA	14-Pin DIP	010	-40°C to +85°C	OPA4344PA	OPA4344PA	Rails
OPA345NA "	SOT23-5 "	331 "	-40°C to +85°C "	A45 "	OPA345NA/250 OPA345NA/3K	Tape and Reel Tape and Reel
OPA345UA "	SO-8 "	182 "	-40°C to +85°C "	OPA345UA "	OPA345UA OPA345UA/2K5	Rails Tape and Reel
OPA2345EA "	MSOP-8 "	337 "	-40°C to +85°C "	B45 "	OPA2345EA/250 OPA2345EA/2K5	Tape and Reel Tape and Reel
OPA2345UA "	SO-8 "	182 "	-40°C to +85°C "	OPA2345UA "	OPA2345UA OPA2345UA/2K5	Rails Tape and Reel
OPA4345EA "	TSSOP-14 "	357 "	-40°C to +85°C "	OPA4345EA "	OPA4345EA/250 OPA4345EA/2K5	Tape and Reel Tape and Reel
OPA4345UA "	SO-14 "	235 "	-40°C to +85°C "	OPA4345UA "	OPA4345UA OPA4345UA/2K5	Rails Tape and Reel

NOTE: (1) Models with a slash (/) are available only in Tape and Reel in the quantities indicated (e.g., /2K5 indicates 2500 devices per reel). Ordering 2500 pieces of "OPA344UA/2K5" will get a single 2500-piece Tape and Reel.

TYPICAL PERFORMANCE CURVES

At $T_A = +25^\circ\text{C}$, $V_S = +5\text{V}$, and $R_L = 10\text{k}\Omega$ connected to $V_S/2$, unless otherwise noted.

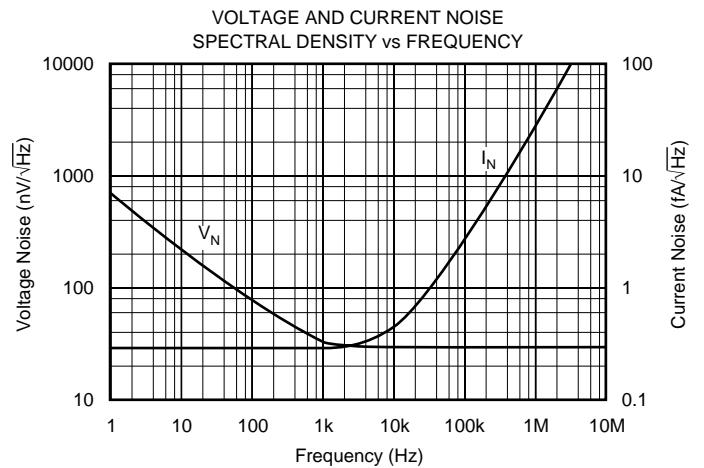
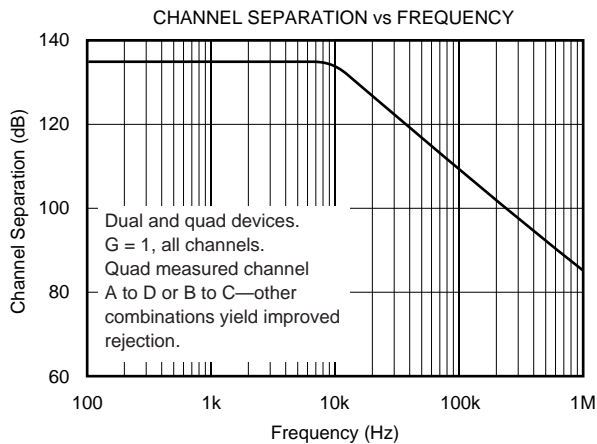
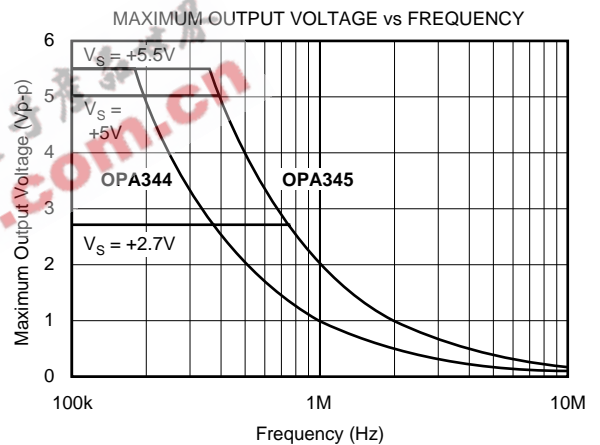
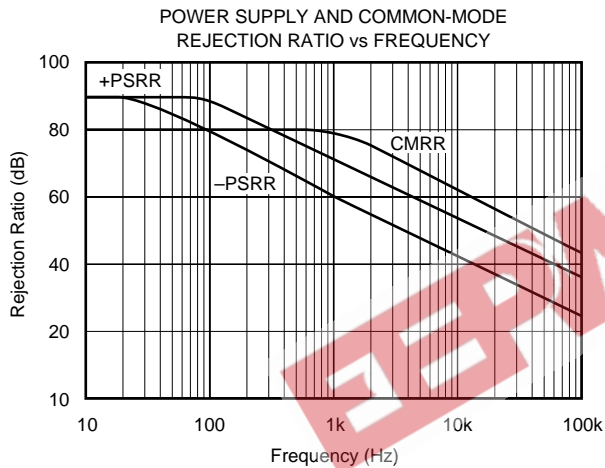
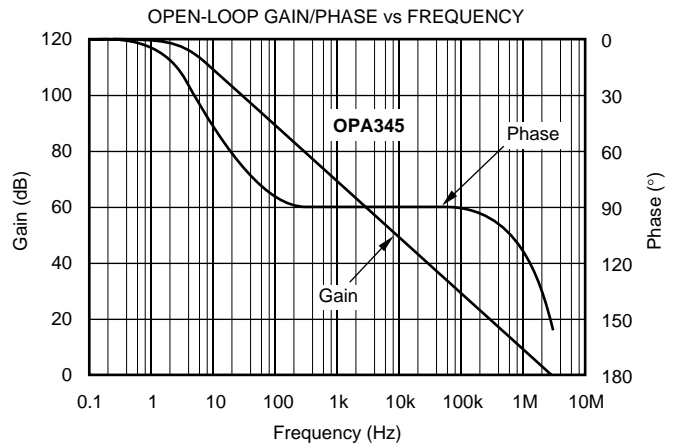
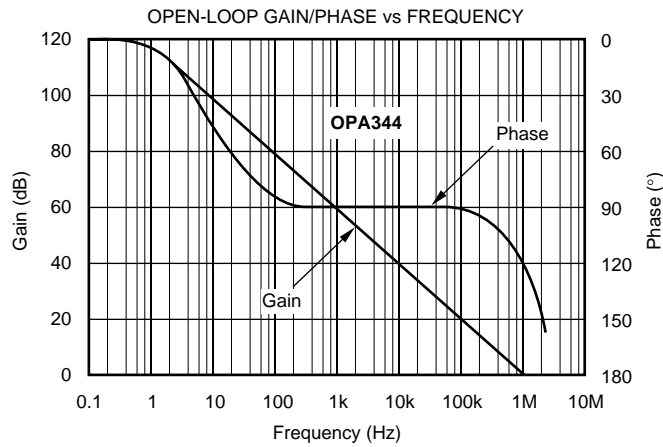

TYPICAL PERFORMANCE CURVES (Cont.)

At $T_A = +25^\circ\text{C}$, $V_S = +5\text{V}$, and $R_L = 10\text{k}\Omega$ connected to $V_S/2$, unless otherwise noted.

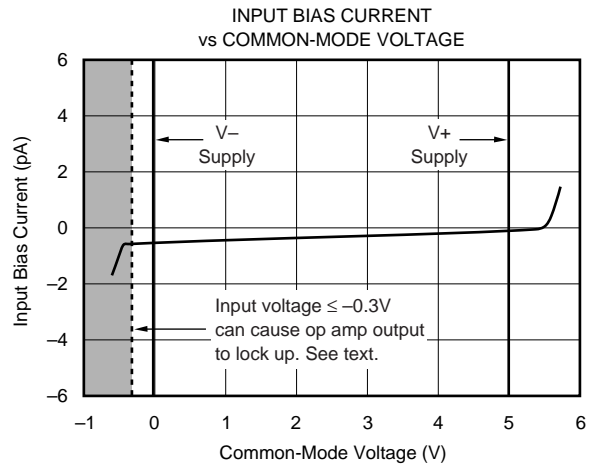
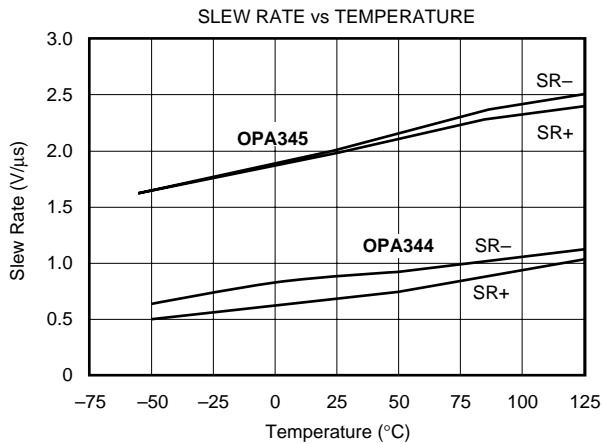
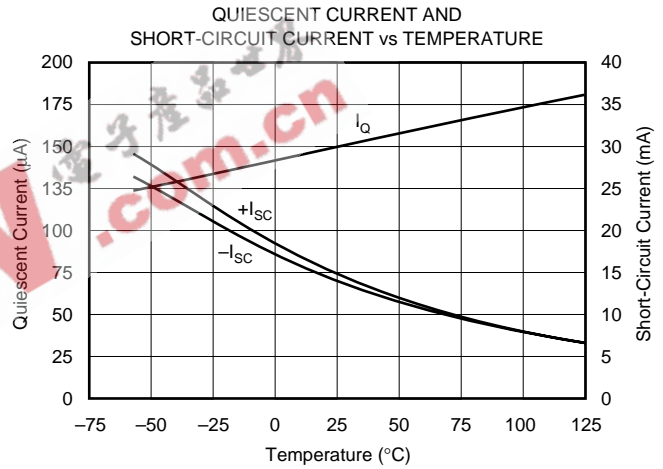
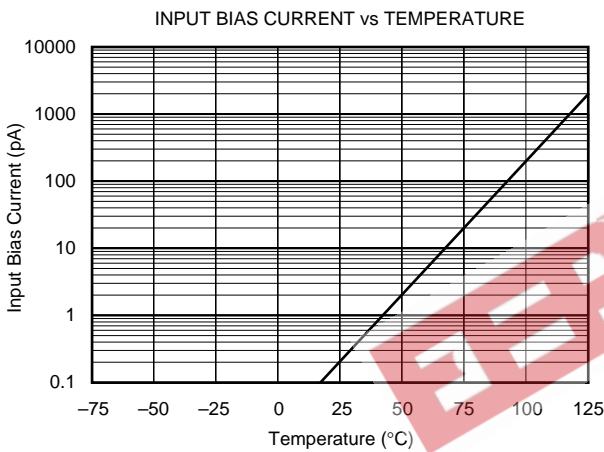
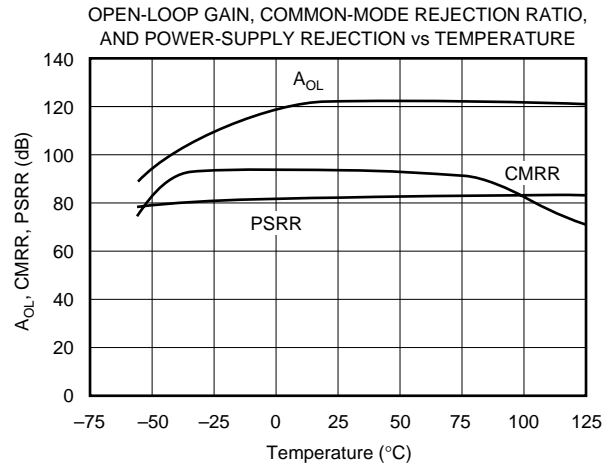
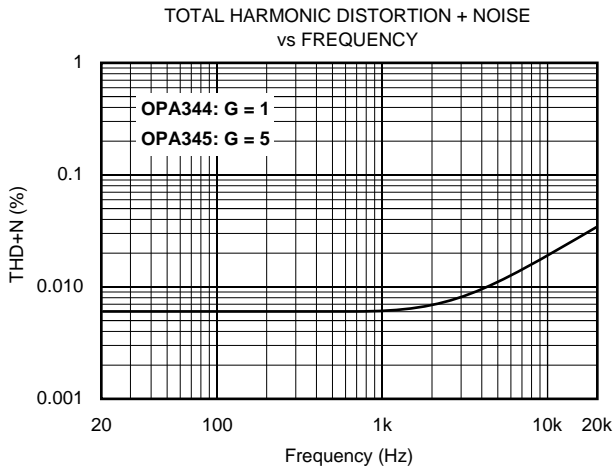

TYPICAL PERFORMANCE CURVES (Cont.)

At $T_A = +25^\circ\text{C}$, $V_S = +5\text{V}$, and $R_L = 10\text{k}\Omega$ connected to $V_S/2$, unless otherwise noted.

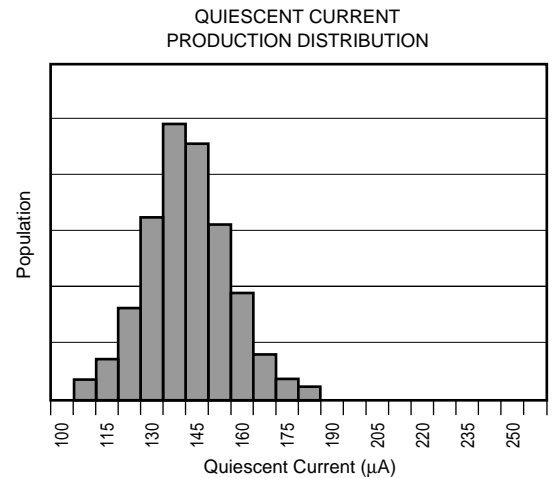
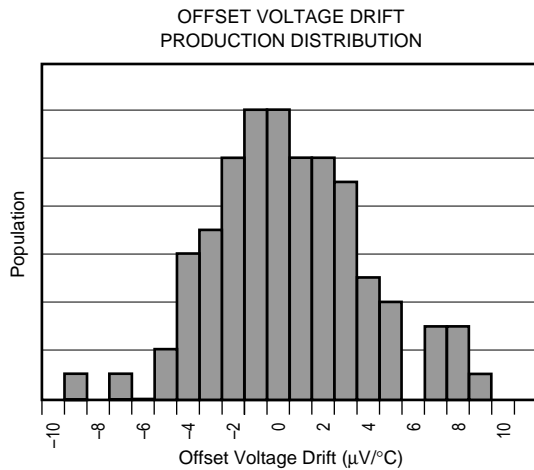
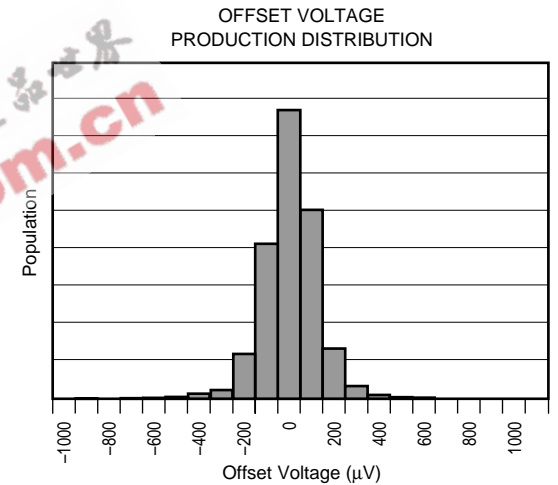
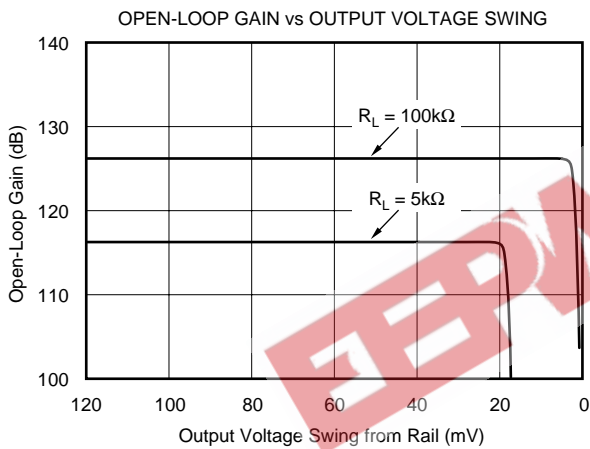
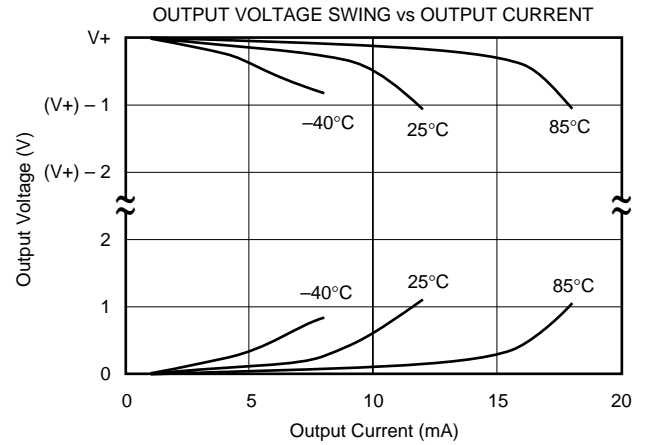
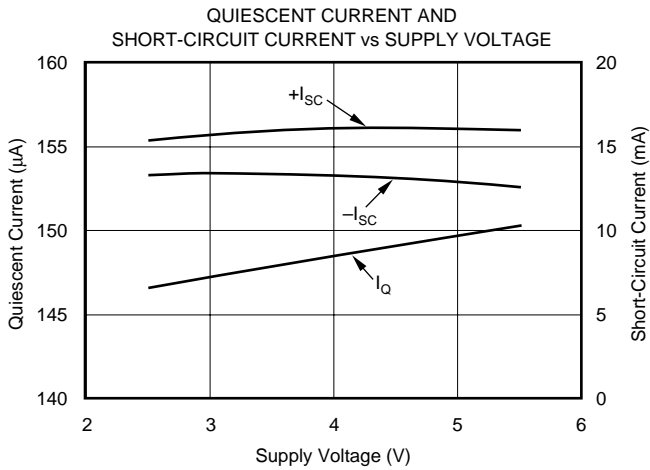

TYPICAL PERFORMANCE CURVES (Cont.)

At $T_A = +25^\circ\text{C}$, $V_S = +5\text{V}$, and $R_L = 10\text{k}\Omega$ connected to $V_S/2$, unless otherwise noted.

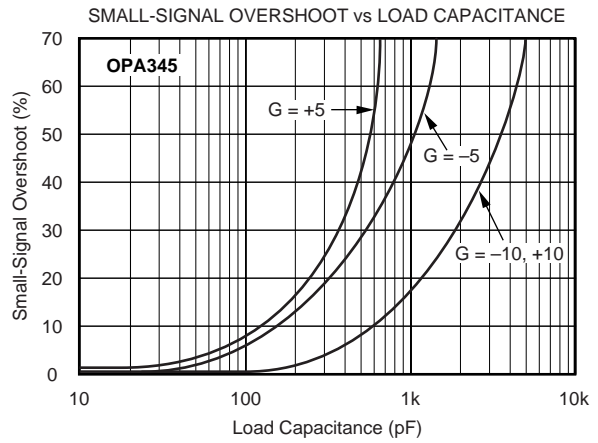
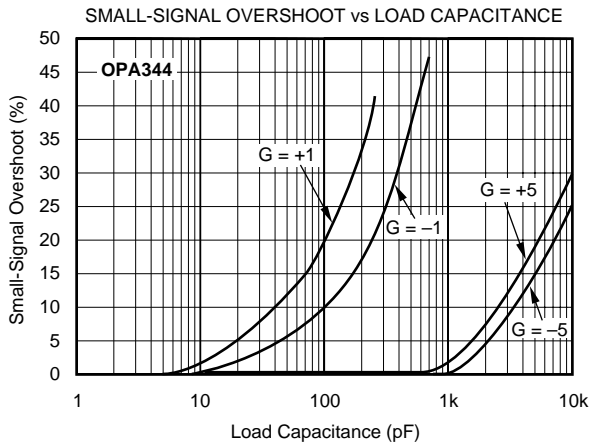

LARGE-SIGNAL STEP RESPONSE: OPA344
 $G = +1$, $R_L = 10\text{k}\Omega$, $C_L = 100\text{pF}$

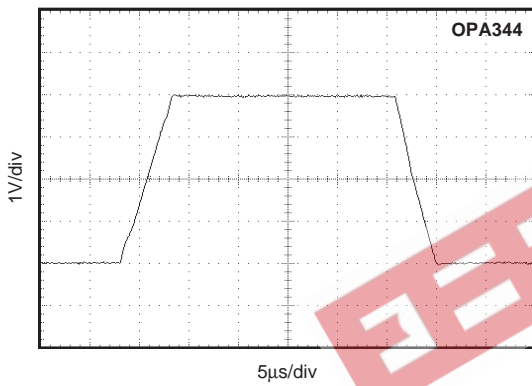

LARGE-SIGNAL STEP RESPONSE: OPA345
 $G = +5$, $R_L = 10\text{k}\Omega$, $C_L = 100\text{pF}$

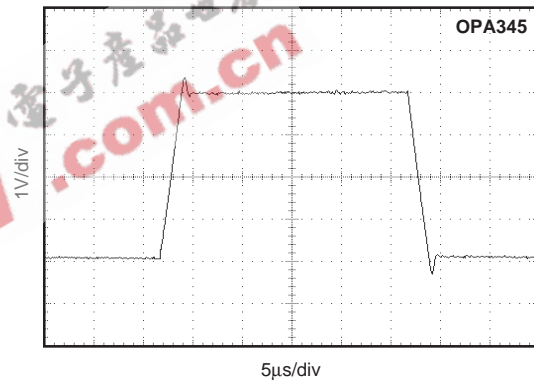

SMALL-SIGNAL STEP RESPONSE: OPA344
 $G = +1$, $R_L = 10\text{k}\Omega$, $C_L = 100\text{pF}$

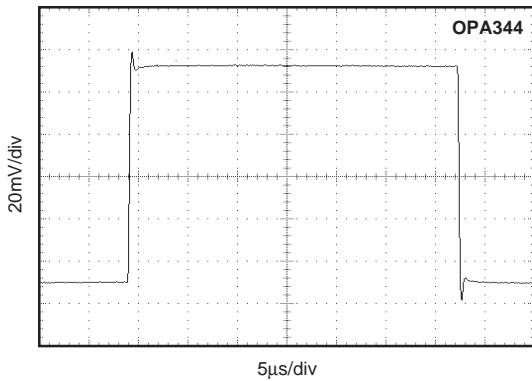

SMALL-SIGNAL STEP RESPONSE: OPA345
 $G = +5$, $R_L = 10\text{k}\Omega$, $C_L = 100\text{pF}$

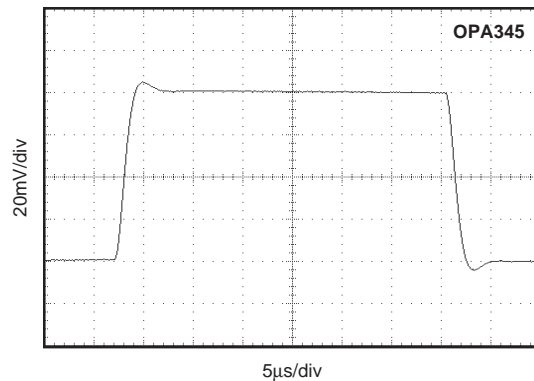

APPLICATIONS INFORMATION

OPA344 series op amps are unity gain stable and can operate on a single supply, making them highly versatile and easy to use. OPA345 series op amps are optimized for applications requiring higher speeds with gains of 5 or greater.

Rail-to-rail input and output swing significantly increases dynamic range, especially in low supply applications. Figure 1 shows the input and output waveforms for the OPA344 in unity-gain configuration. Operation is from $V_S = +5V$ with a $10k\Omega$ load connected to $V_S/2$. The input is a $5Vp-p$ sinusoid. Output voltage is approximately $4.997Vp-p$.

Power supply pins should be bypassed with $0.01\mu F$ ceramic capacitors.

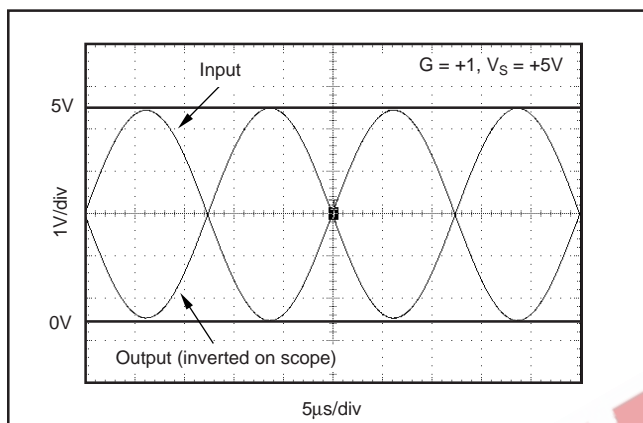

FIGURE 1. Rail-to-Rail Input and Output.

OPERATING VOLTAGE

OPA344 and OPA345 series op amps are fully specified and guaranteed from $+2.7V$ to $+5.5V$. In addition, many specifications apply from $-40^{\circ}C$ to $+85^{\circ}C$. Parameters that vary significantly with operating voltages or temperature are shown in the Typical Performance Curves.

RAIL-TO-RAIL INPUT

The input common-mode voltage range of the OPA344 and OPA345 series extends $300mV$ beyond the supply rails. This is achieved with a complementary input stage—an N-channel input differential pair in parallel with a P-channel differential pair (see Figure 2). The N-channel pair is active for input voltages close to the positive rail, typically $(V+) - 1.3V$ to $300mV$ above the positive supply, while the P-channel pair is on for inputs from $300mV$ below the negative supply to approximately $(V+) - 1.3V$. There is a small transition region, typically $(V+) - 1.5V$ to $(V+) - 1.1V$, in which both pairs are on. This $400mV$ transition region can vary $300mV$ with process variation. Thus, the transition region (both stages on) can range from $(V+) - 1.8V$ to $(V+) - 1.4V$ on the low end, up to $(V+) - 1.2V$ to $(V+) - 0.8V$ on the high end. Within the $400mV$ transition region PSRR, CMRR, offset voltage, offset drift, and THD may be degraded compared to operation outside this region. For more information on designing with rail-to-rail input op amps, see Figure 3 “Design Optimization with Rail-to-Rail Input Op Amps.”

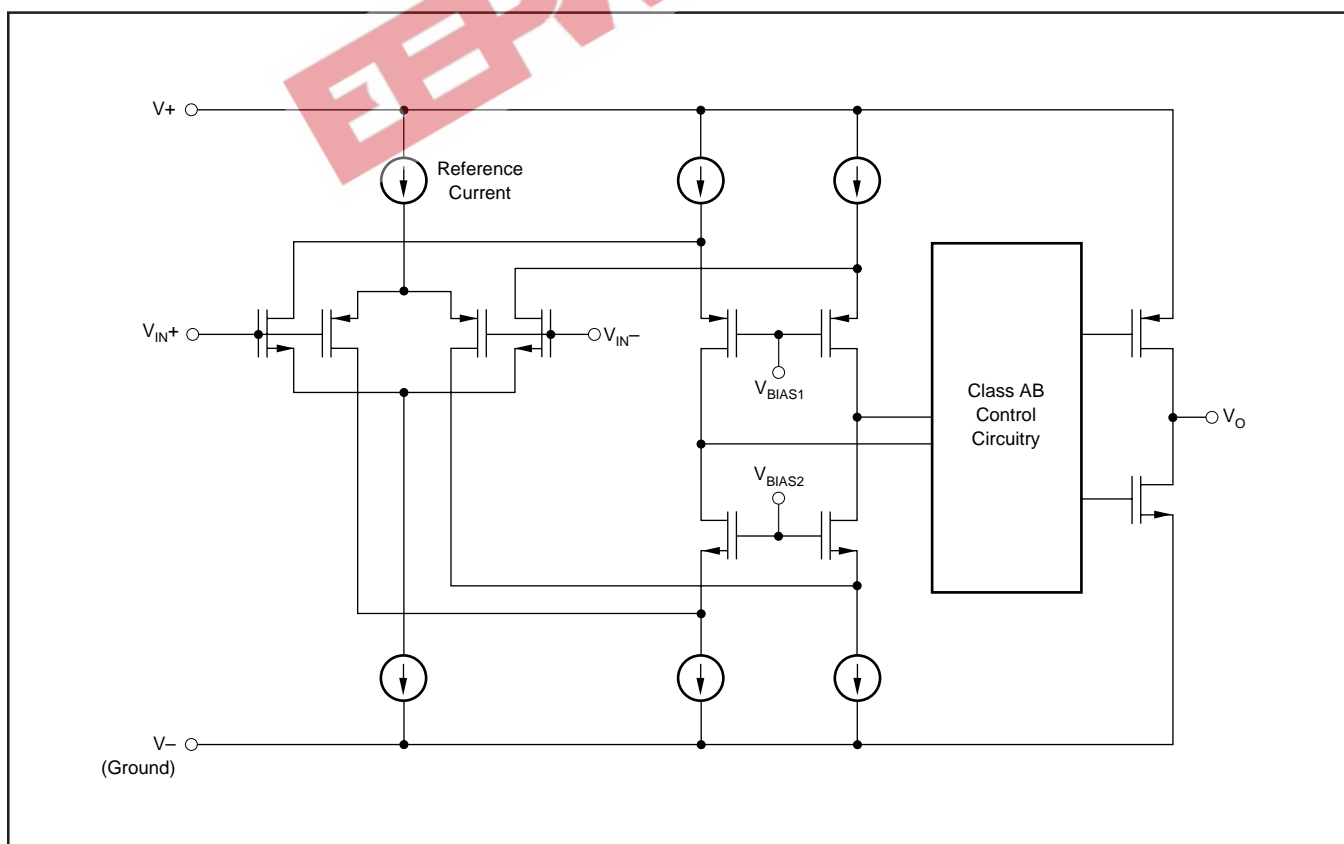

FIGURE 2. Simplified Schematic.

DESIGN OPTIMIZATION WITH RAIL-TO-RAIL INPUT OP AMPS

Rail-to-rail op amps can be used in virtually any op amp configuration. To achieve optimum performance, however, applications using these special double-input-stage op amps may benefit from consideration of their special behavior.

In many applications, operation remains within the common-mode range of only one differential input pair. However some applications exercise the amplifier through the transition region of both differential input stages. Although the two input stages are laser trimmed for excellent matching, a small discontinuity may occur in this transition. Careful selection of the circuit configuration, signal levels and biasing can often avoid this transition region.

With a unity-gain buffer, for example, signals will traverse this transition at approximately 1.3V below V_+ supply and may exhibit a small discontinuity at this point.

The common-mode voltage of the non-inverting amplifier is equal to the input voltage. If the input signal always remains less than the transition voltage, no discontinuity will be created. The closed-loop gain of this configuration can still produce a rail-to-rail output.

Inverting amplifiers have a constant common-mode voltage equal to V_B . If this bias voltage is constant, no discontinuity will be created. The bias voltage can generally be chosen to avoid the transition region.

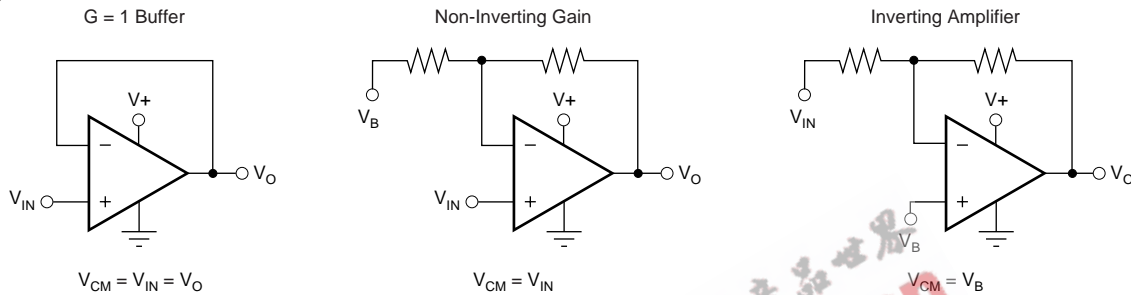

FIGURE 3. Design Optimization with Rail-to-Rail Input Op Amps.

COMMON-MODE REJECTION

The CMRR for the OPA344 and OPA345 is specified in several ways so the best match for a given application may be used. First, the CMRR of the device in the common-mode range below the transition region ($V_{CM} < (V_+) - 1.8V$) is given. This specification is the best indicator of the capability of the device when the application requires use of one of the differential input pairs. Second, the CMRR at $V_S = 5.5V$ over the entire common-mode range is specified. Third, the CMRR at $V_S = 2.7V$ over the entire common-mode range is provided. These last two values include the variations seen through the transition region.

INPUT VOLTAGE BEYOND THE RAILS

If the input voltage can go more than 0.3V below the negative power supply rail (single-supply ground), special precautions are required. If the input voltage goes sufficiently negative, the op amp output may lock up in an inoperative state. A Schottky diode clamp circuit will prevent this—see Figure 4. The series resistor prevents excessive current (greater than 10mA) in the Schottky diode and in the internal ESD protection diode, if the input voltage can exceed the positive supply voltage. If the signal source is limited to less than 10mA, the input resistor is not required.

RAIL-TO-RAIL OUTPUT

A class AB output stage with common-source transistors is used to achieve rail-to-rail output. This output stage is capable of driving 600Ω loads connected to any potential

between V_+ and ground. For light resistive loads ($> 50k\Omega$), the output voltage can typically swing to within 1mV from supply rail. With moderate resistive loads ($2k\Omega$ to $50k\Omega$), the output can swing to within a few tens of milli-volts from the supply rails while maintaining high open-loop gain. See the typical performance curve “Output Voltage Swing vs Output Current.”

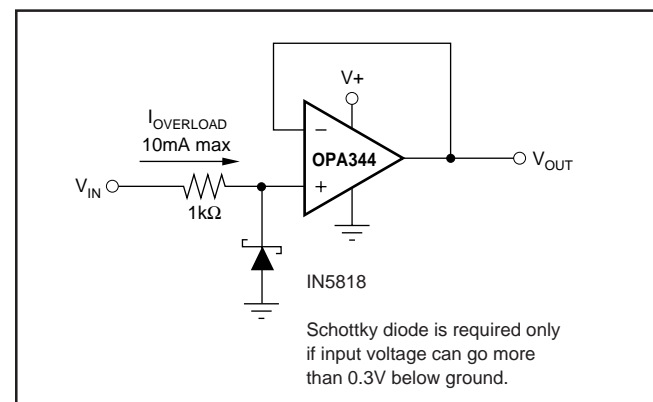

FIGURE 4. Input Current Protection for Voltages Exceeding the Supply Voltage.

CAPACITIVE LOAD AND STABILITY

The OPA344 in a unity-gain configuration and the OPA345 in gains greater than 5 can directly drive up to 250pF pure capacitive load. Increasing the gain enhances the amplifier’s ability to drive greater capacitive loads. See the typical

performance curve “Small-Signal Overshoot vs Capacitive Load.” In unity-gain configurations, capacitive load drive can be improved by inserting a small (10Ω to 20Ω) resistor, R_S , in series with the output, as shown in Figure 5. This significantly reduces ringing while maintaining dc performance for purely capacitive loads. However, if there is a resistive load in parallel with the capacitive load, a voltage divider is created, introducing a dc error at the output and slightly reducing the output swing. The error introduced is proportional to the ratio R_S/R_L , and is generally negligible.

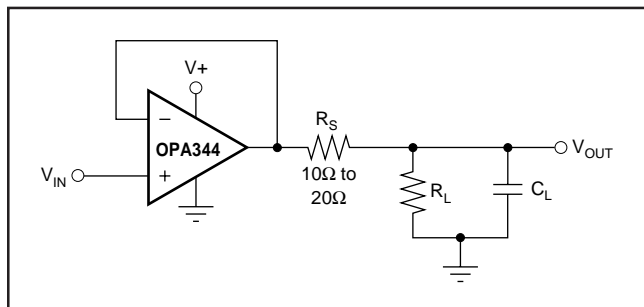

FIGURE 5. Series Resistor in Unity-Gain Configuration Improves Capacitive Load Drive.

DRIVING A/D CONVERTERS

The OPA344 and OPA345 series op amps are optimized for driving medium-speed sampling A/D converters. The OPA344 and OPA345 op amps buffer the A/D’s input capacitance and resulting charge injection while providing signal gain.

Figure 6 shows the OPA344 in a basic noninverting configuration driving the ADS7822. The ADS7822 is a 12-bit, micro-power sampling converter in the MSOP-8 package. When used with the low-power, miniature packages of the OPA344, the combination is ideal for space-limited, low-power applications. In this configuration, an RC network at the A/D’s input can be used to filter charge injection.

Figure 7 shows the OPA2344 driving an ADS7822 in a speech bandpass filtered data acquisition system. This small, low-cost solution provides the necessary amplification and signal conditioning to interface directly with an electret microphone. This circuit will operate with $V_S = +2.7V$ to $+5V$ with less than $500\mu A$ quiescent current.

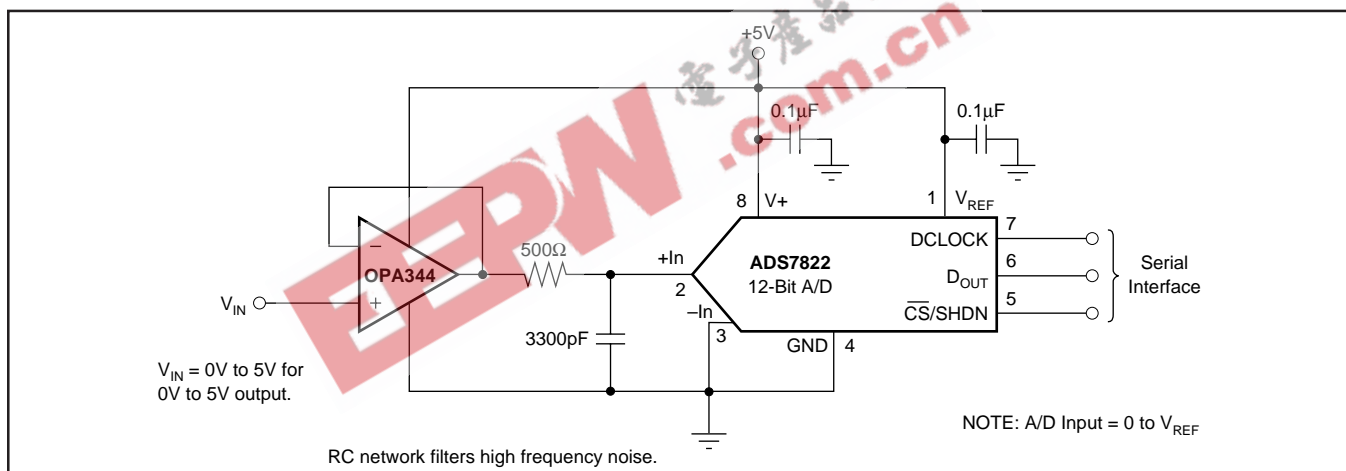

FIGURE 6. OPA344 in Noninverting Configuration Driving ADS7822.

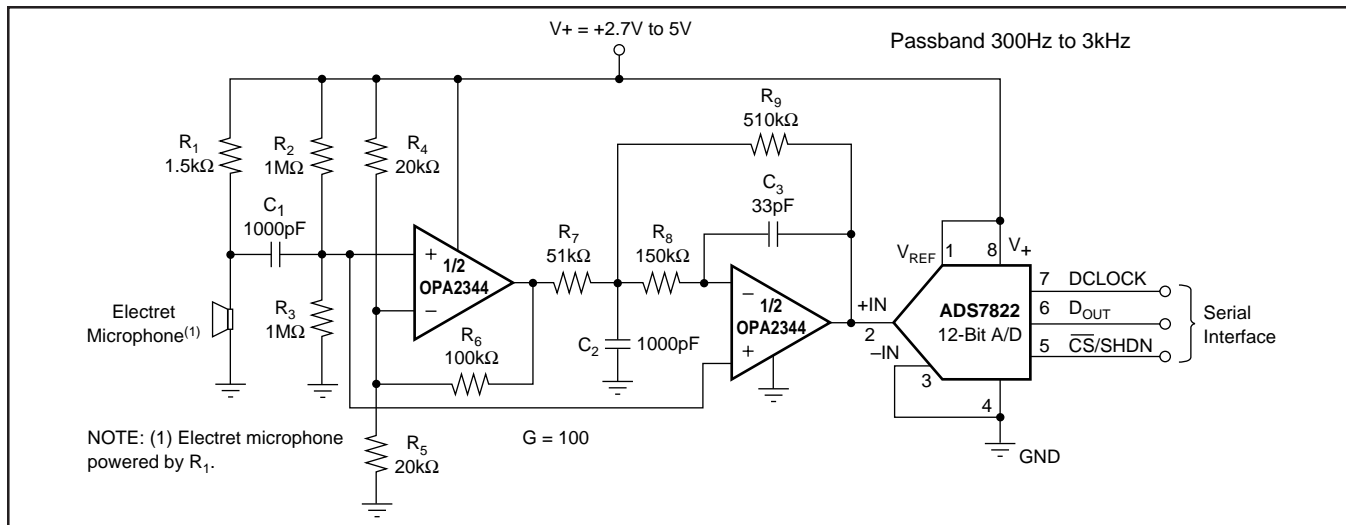

FIGURE 7. Speech Bandpass Filtered Data Acquisition System.