

OPA21

AVAILABLE IN
DIE FORM

OPA21

2

Low-Power Precision OPERATIONAL AMPLIFIER

FEATURES

- **LOW SUPPLY CURRENT**
230 μ A max at $V_{CC} = \pm 15V$
- **WIDE SUPPLY RANGE**
 $\pm 2.5V$ to $\pm 18V$
- **LOW OFFSET VOLTAGE**
100 μ V max
- **LOW OFFSET VOLTAGE DRIFT**
1.0 μ V/ $^{\circ}$ C max

APPLICATIONS

- **PORTABLE EQUIPMENT**
- **BATTERY OPERATION**
- **IMPROVED REPLACEMENT FOR OP-21**

DESCRIPTION

A unique circuit design, state-of-the-art monolithic processing and advanced laser-trimming techniques are used to provide a low power amplifier with outstanding parameters—truly “instrumentation grade” performance over a wide voltage supply range.

The OPA21 consumes only 6.9mW of power at $V_{CC} = \pm 15V$ and 1.1mW at $V_{CC} = \pm 2.5V$ but offers far higher performance than MOS op-amps.

The OPA21 is internally compensated for unity-gain stability.

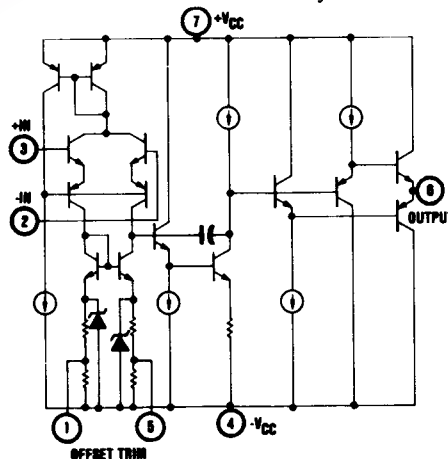

SIMPLIFIED CIRCUIT

International Airport Industrial Park - P.O. Box 11400 - Tucson, Arizona 85734 - Tel. (602) 746-1111 - Twx: 910-952-1111 - Cable: BBRCORP - Telex: 66-6401

PDS-482C

SPECIFICATIONS

ELECTRICAL

At $T_A = +25^\circ\text{C}$ and $\pm V_{CC} = 2.5\text{VDC}$ to 15VDC , unless otherwise noted.

PARAMETERS	CONDITIONS	OPA21E			OPA21G			UNITS
		MIN	TYP	MAX	MIN	TYP	MAX	
INPUT OFFSET VOLTAGE OFFSET VOLTAGE ⁽¹⁾			40	100		300	500	μV
Drift	-25°C to $+85^\circ\text{C}$		75	200		500	1000	μV
Offset Adjustment Range	-25°C to $+85^\circ\text{C}$		0.5	1.0		2.5	5.0	$\mu\text{V}/^\circ\text{C}$
			± 4			*		mV
INPUT OFFSET CURRENT								
Offset Current	-25°C to $+85^\circ\text{C}$		0.3	1		1.2	4	nA
			0.5	2		2	6	nA
INPUT BIAS CURRENT								
Bias Current	-25°C to $+85^\circ\text{C}$		7	25		15	50	nA
			9	40		18	75	nA
INPUT NOISE								
Voltage	0.1Hz to 10Hz		1.0			*		$\mu\text{V p-p}$
Voltage Density	$f_o = 1\text{Hz}$		60			*		$\text{nV}/\sqrt{\text{Hz}}$
	$f_o = 10\text{Hz}$		20			*		$\text{nV}/\sqrt{\text{Hz}}$
	$f_o = 100\text{Hz}$		20			*		$\text{nV}/\sqrt{\text{Hz}}$
Current Density	$f_o = 1\text{Hz}$		0.7			*		$\text{pA}/\sqrt{\text{Hz}}$
	$f_o = 10\text{Hz}$		0.25			*		$\text{pA}/\sqrt{\text{Hz}}$
	$f_o = 100\text{Hz}$		0.07			*		$\text{pA}/\sqrt{\text{Hz}}$
INPUT RESISTANCE								
Differential			6			4		M Ω
Common-Mode			$10^{10} \parallel 2$			*		$\Omega \parallel \text{pF}$
INPUT VOLTAGE RANGE								
Input Voltage Range	-25°C to $+85^\circ\text{C}$		-12.5			*		V
			+14.3			*		V
			-12.0			*		V
			+14.0			*		V
COMMON-MODE REJECTION RATIO								
CMRR	$V_{CM} = -12\text{V}$ to $+14\text{V}$, $R_L = 100\text{k}\Omega$	100	110		84	100		dB
	-25°C to $+85^\circ\text{C}$	96	105		80	95		dB
POWER SUPPLY REJECTION RATIO								
PSRR	$\pm V_{CC} = 2.5\text{V}$ to 18V , $R_L = 100\text{k}\Omega$	104	114		90	100		dB
	-25°C to $+85^\circ\text{C}$	100	108		85	95		dB
LARGE SIGNAL VOLTAGE GAIN								
Open-Loop Voltage Gain	$R_L = 10\text{k}\Omega$	1000	2000		500	1000		V/mV
	-25°C to $+85^\circ\text{C}$	120	126		114	120		dB
		500	1500		250	1000		V/mV
		114	124		108	120		dB
RATED OUTPUT								
Output Voltage Swing	$R_L = 10\text{k}\Omega$	-13.7	-14.2		-13.6	*		V
		+14.0	+14.1		+13.8	*		V
Output Current	$R_L = 2\text{k}\Omega$		5		*	*		mA
	-25°C to $+85^\circ\text{C}$, $R_L = 10\text{k}\Omega$	-13.5			*	*		V
		+13.8			+13.6	*		V
Output Resistance	Open-Loop		500			*		Ω
DYNAMIC RESPONSE								
Slew Rate	$C_L = 100\text{pF}$, $R_L = 25\text{k}\Omega$		0.2			*		V/ μsec
Closed-Loop Bandwidth	$A_{CL} = +1$, $R_L = 10\text{k}\Omega$		300			*		kHz
POWER SUPPLY								
Rated Voltage		± 2.5	± 15		*	*		VDC
Voltage Range	Derated			± 18	*	*		VDC
Current Quiescent	$I_o = 0\text{mA}$					*		μA
	$\pm V_{CC} = 2.5\text{V}$		170	210		250		μA
	$\pm V_{CC} = 15\text{V}$		200	230		325		μA
	$\pm V_{CC} = 2.5\text{V}$, -25°C to $+85^\circ\text{C}$		210	275		325		μA
	$\pm V_{CC} = 15\text{V}$, -25°C to $+85^\circ\text{C}$		230	325		375		μA
TEMPERATURE RANGE								
Specification	Ambient	-25		+85	*	*		$^\circ\text{C}$
Operating	Ambient	-55		+125	*	*		$^\circ\text{C}$

NOTE: (1) Guaranteed fully warmed-up.

*Specification same as OPA21E.

ABSOLUTE MAXIMUM RATINGS

Supply Voltage	±18V
Internal Power Dissipation ⁽¹⁾	500mW
Input Voltage	Supply Voltage
Differential Input Voltage	±30V
Output Short Circuit Duration	Indefinite
Storage Temperature Range	-65°C to +150°C
Operating Temperature Range	-55°C to +125°C
Lead Temperature Range (soldering, 60sec)	+300°C

NOTE: (1) Maximum package power dissipation vs ambient temperature:

Package Type	Maximum Ambient Temperature for Rating	Derate Above Maximum Ambient Temperature
8-Pin Hermetic DIP (Z)	+75°C	6.7mW/°C

MECHANICAL

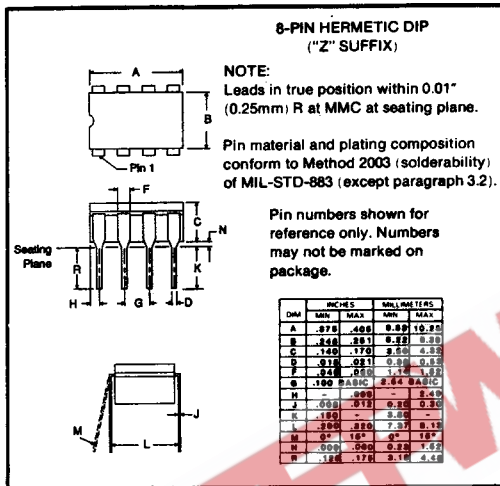

PIN CONFIGURATION

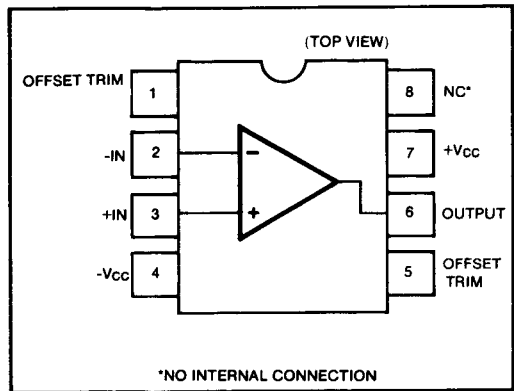

ORDERING INFORMATION

Basic Model Number	OPA21	E	Z
Performance Grade Code			
E, G =	-25°C to +85°C		
Package Code			
Z =	8-Pin Hermetic DIP		

TYPICAL PERFORMANCE CURVES

(T_A = +25°C, ±V_{CC} = 15VDC unless otherwise noted)

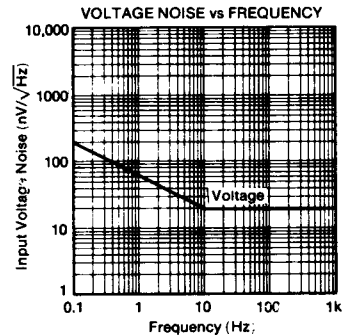
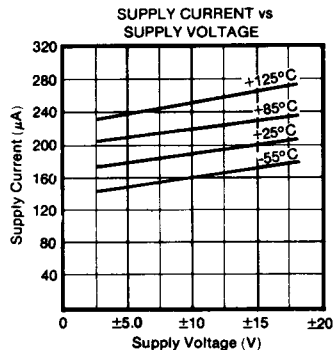
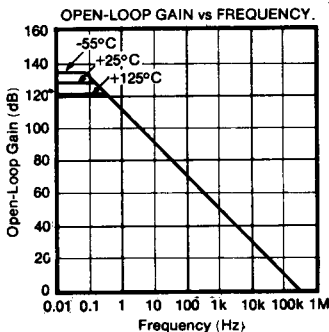

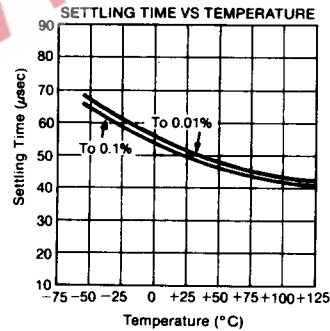
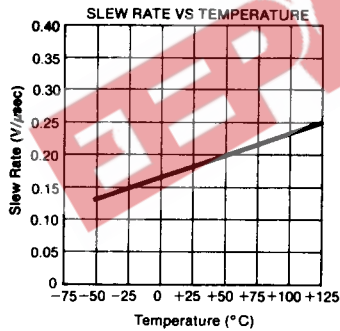
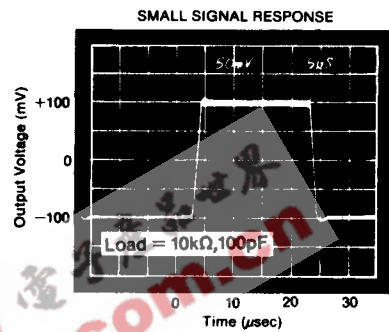
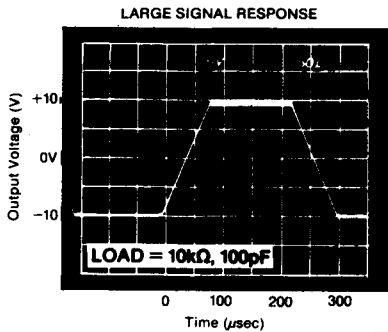
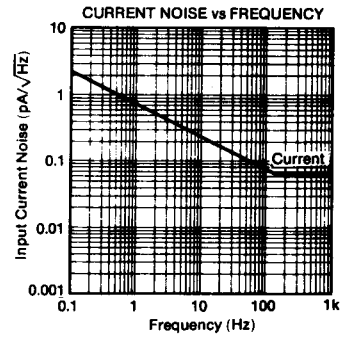
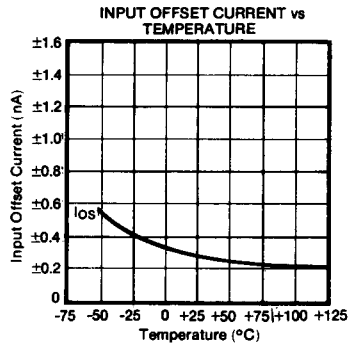
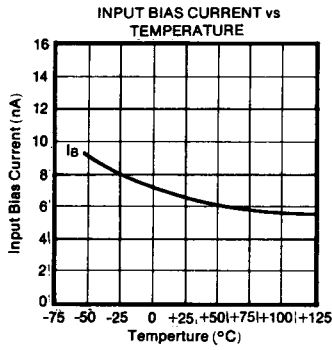

APPLICATIONS

Figures 1 through 6 are typical applications of the OPA21.

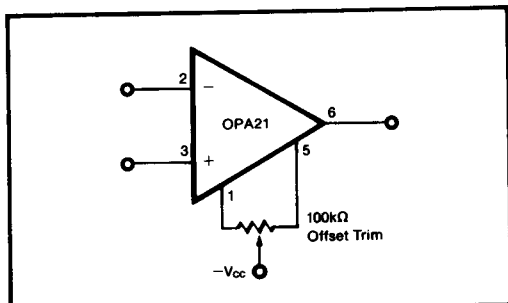

FIGURE 1. Voltage Offset Trim.

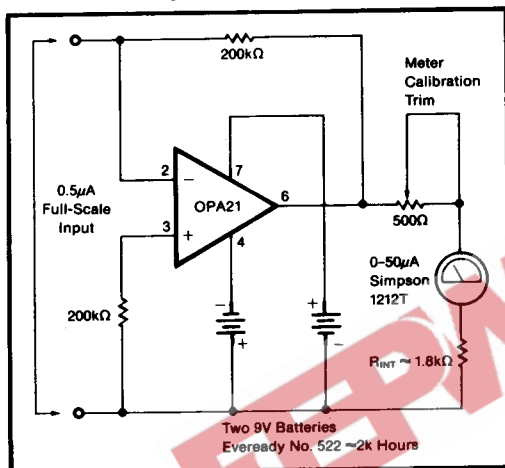

FIGURE 2. Fully-Floating Current Meter.

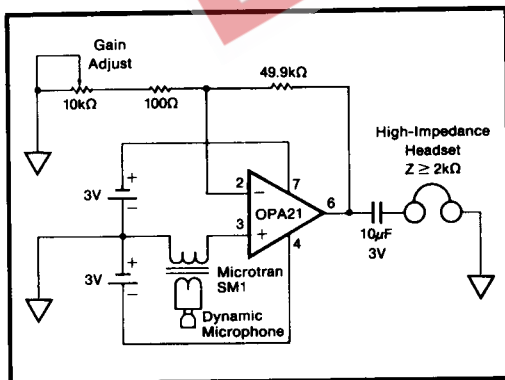

FIGURE 3. Portable Microphone Amplifier.

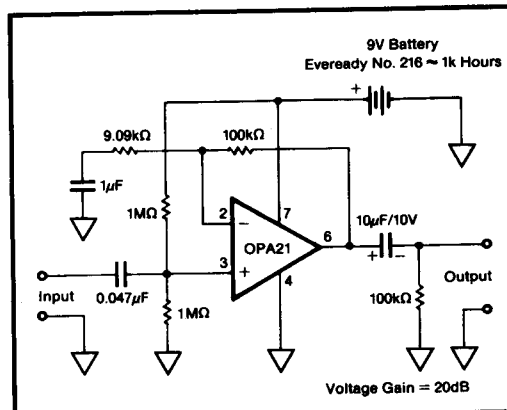

FIGURE 4. AC Amplifier.

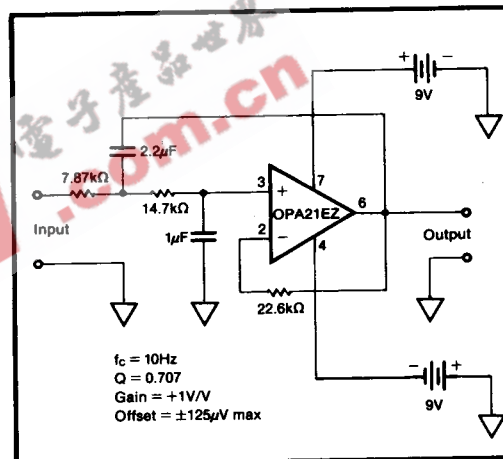

FIGURE 5. Second-Order 10Hz Low-Pass Filter.

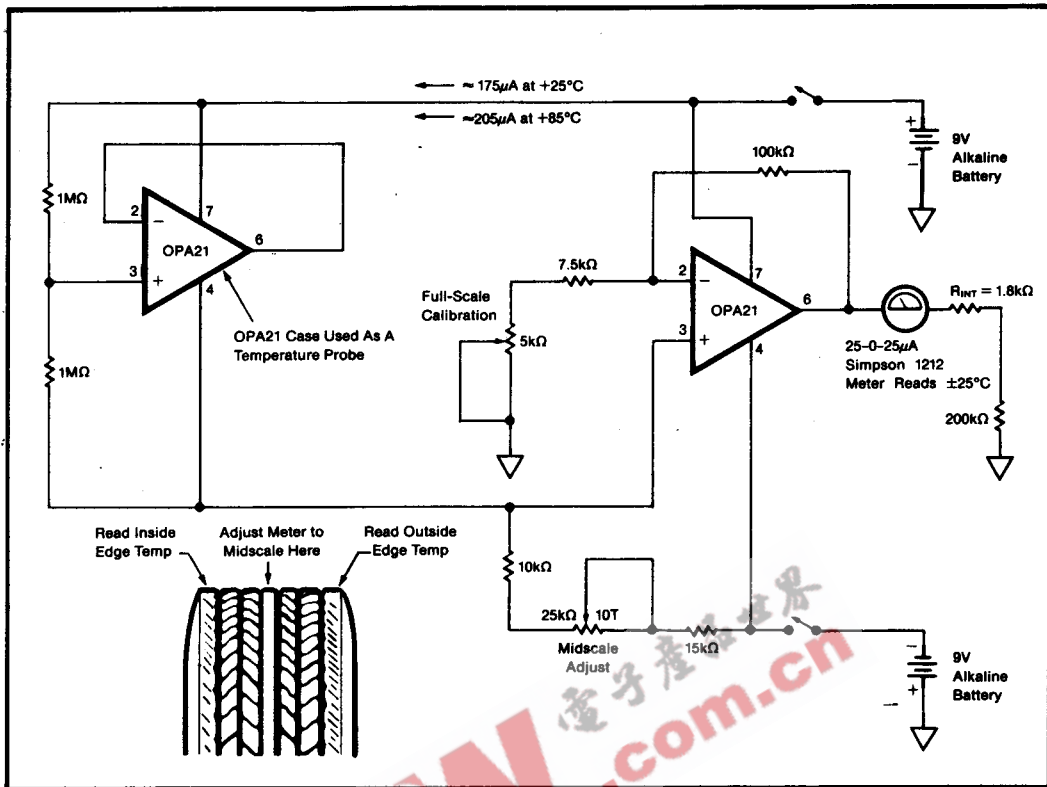

FIGURE 6. Portable Tire Pyrometer.