

OPA241
OPA2241
OPA4241
OPA251
OPA2251
OPA4251

Single-Supply, *MicroPOWER* OPERATIONAL AMPLIFIERS

OPA241 Family optimized for +5V supply.

OPA251 Family optimized for $\pm 15V$ supply.

FEATURES

- **MicroPOWER:** $I_Q = 25\mu A$
- **SINGLE-SUPPLY OPERATION**
- **RAIL-TO-RAIL OUTPUT (within 50mV)**
- **WIDE SUPPLY RANGE**
 Single Supply: +2.7V to +36V
 Dual Supply: $\pm 1.35V$ to $\pm 18V$
- **LOW OFFSET VOLTAGE:** $\pm 250\mu V$ max
- **HIGH COMMON-MODE REJECTION:** 124dB
- **HIGH OPEN-LOOP GAIN:** 128dB
- **SINGLE, DUAL, AND QUAD**

APPLICATIONS

- **BATTERY OPERATED INSTRUMENTS**
- **PORTABLE DEVICES**
- **MEDICAL INSTRUMENTS**
- **TEST EQUIPMENT**

DESCRIPTION

The OPA241 series and OPA251 series are specifically designed for battery powered, portable applications. In addition to very low power consumption ($25\mu A$), these amplifiers feature low offset voltage, rail-to-rail output swing, high common-mode rejection, and high open-loop gain.

The OPA241 series is optimized for operation at low power supply voltage while the OPA251 series is optimized for high power supplies. Both can operate from either single (+2.7V to +36V) or dual supplies ($\pm 1.35V$ to $\pm 18V$). The input common-mode voltage range extends 200mV below the negative supply—ideal for single-supply applications.

They are unity-gain stable and can drive large capacitive loads. Special design considerations assure that these products are easy to use. High performance is maintained as the amplifiers swing to their specified limits. Because the initial offset voltage ($\pm 250\mu V$ max) is so low, user adjustment is usually not required. However, external trim pins are provided for special applications (single versions only).

The OPA241 and OPA251 (single versions) are available in standard 8-pin DIP and SO-8 surface-mount packages. The OPA2241 and OPA2251 (dual versions) come in 8-pin DIP and SO-8 surface-mount packages. The OPA4241 and OPA4251 (quad versions) are available in 14-pin DIP and SO-14 surface-mount packages. All are fully specified from $-40^\circ C$ to $+85^\circ C$ and operate from $-55^\circ C$ to $+125^\circ C$.

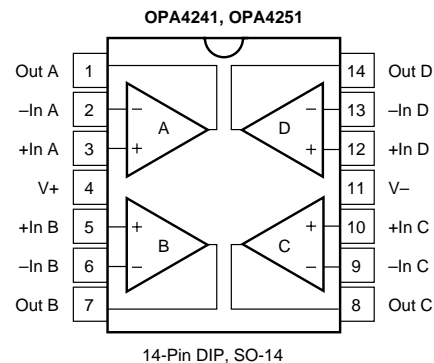
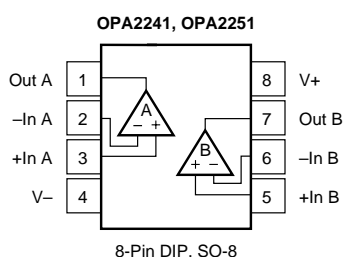
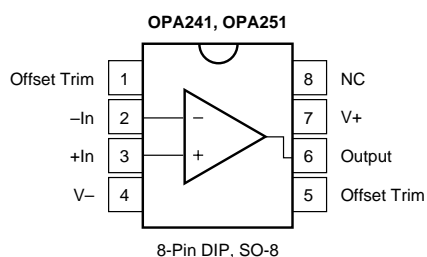

SPECIFICATIONS: $V_S = 2.7V$ to $5V$

At $T_A = +25^\circ C$, $R_L = 100k\Omega$ connected to $V_S/2$, unless otherwise noted.

Boldface limits apply over the specified temperature range, $T_A = -40^\circ C$ to $+85^\circ C$.

| PARAMETER | CONDITION | OPA241UA, PA OPA2241UA, PA OPA4241UA, PA | | | OPA251UA, PA OPA2251UA, PA OPA4251UA, PA | | | UNITS |
|--|--|--|--|---|--|---|-------------|--|
| | | MIN | TYP ⁽¹⁾ | MAX | MIN | TYP ⁽¹⁾ | MAX | |
| OFFSET VOLTAGE Input Offset Voltage V_{OS} $T_A = -40^\circ C$ to $+85^\circ C$ vs Temperature dV_{OS}/dT vs Power Supply PSRR $T_A = -40^\circ C$ to $+85^\circ C$ Channel Separation (dual, quad) | $T_A = -40^\circ C$ to $+85^\circ C$ $V_S = 2.7V$ to $36V$ $V_S = 2.7V$ to $36V$ | | ± 50 ± 100 ± 0.4 3 0.3 | ± 250 ± 400 30 30 | | ± 100 ± 130 ± 0.6 * * | * * * | μV μV $\mu V/^\circ C$ $\mu V/V$ $\mu V/V$ |
| INPUT BIAS CURRENT Input Bias Current ⁽²⁾ I_B $T_A = -40^\circ C$ to $+85^\circ C$ Input Offset Current I_{OS} $T_A = -40^\circ C$ to $+85^\circ C$ | | | -4 ± 0.1 | -20 -25 ± 2 | | * * | | nA nA nA nA |
| NOISE Input Voltage Noise, $f = 0.1Hz$ to $10Hz$ Input Voltage Noise Density, $f = 1kHz$ e_n Current Noise Density, $f = 1kHz$ i_n | | | 1 45 40 | | | * * * | | $\mu Vp-p$ nV/\sqrt{Hz} fA/\sqrt{Hz} |
| INPUT VOLTAGE RANGE Common-Mode Voltage Range V_{CM} Common-Mode Rejection Ratio CMRR $T_A = -40^\circ C$ to $+85^\circ C$ | $V_{CM} = -0.2V$ to $(V+) - 0.8V$ $V_{CM} = 0V$ to $(V+) - 0.8V$ | -0.2 80 80 | 106 | (V+) - 0.8 | | * | | V dB dB |
| INPUT IMPEDANCE Differential Common-Mode | | | $10^7 \parallel 2$ $10^9 \parallel 4$ | | | * * | | $\Omega \parallel pF$ $\Omega \parallel pF$ |
| OPEN-LOOP GAIN Open-Loop Voltage Gain A_{OL} $T_A = -40^\circ C$ to $+85^\circ C$ $T_A = -40^\circ C$ to $+85^\circ C$ | $R_L = 100k\Omega$, $V_O = (V-) + 100mV$ to $(V+) - 100mV$ $R_L = 100k\Omega$, $V_O = (V-) + 100mV$ to $(V+) - 100mV$ $R_L = 10k\Omega$, $V_O = (V-) + 200mV$ to $(V+) - 200mV$ $R_L = 10k\Omega$, $V_O = (V-) + 200mV$ to $(V+) - 200mV$ | 100 100 100 100 | 120 120 | | | * * * | | dB dB dB dB |
| FREQUENCY RESPONSE Gain-Bandwidth Product GBW Slew Rate SR Overload Recovery Time | $V_S = 5V$, $G = 1$ $V_{IN} \cdot G = V_S$ | | 35 0.01 60 | | | * * * | | kHz V/ μs μs |
| OUTPUT Voltage Output Swing from Rail ⁽³⁾ V_O $T_A = -40^\circ C$ to $+85^\circ C$ $T_A = -40^\circ C$ to $+85^\circ C$ Short-Circuit Current I_{SC} Single Versions Dual, Quad Versions Capacitive Load Drive C_{LOAD} | $R_L = 100k\Omega$ to $V_S/2$, $A_{OL} \geq 70dB$ $R_L = 100k\Omega$ to $V_S/2$, $A_{OL} \geq 100dB$ $R_L = 100k\Omega$ to $V_S/2$, $A_{OL} \geq 100dB$ $R_L = 10k\Omega$ to $V_S/2$, $A_{OL} \geq 100dB$ $R_L = 10k\Omega$ to $V_S/2$, $A_{OL} \geq 100dB$ | | 50 75 100 | 100 200 200 | | * * * * | | mV mV mV mV mA mA |
| POWER SUPPLY Specified Voltage Range V_S Operating Voltage Range Quiescent Current (per amplifier) I_Q $T_A = -40^\circ C$ to $+85^\circ C$ | $T_A = -40^\circ C$ to $+85^\circ C$ $I_O = 0$ $I_O = 0$ | +2.7 | +2.7 to +5 ± 25 | +36 ± 30 ± 36 | * | * * | * | V V μA μA |
| TEMPERATURE RANGE Specified Range Operating Range Storage Range Thermal Resistance θ_{JA} 8-Pin DIP SO-8 Surface Mount 14-Pin DIP SO-14 Surface Mount | | -40 -55 -55 | | +85 +125 +125 | * * * | | * * * | $^\circ C$ $^\circ C$ $^\circ C$ $^\circ C/W$ $^\circ C/W$ $^\circ C/W$ $^\circ C/W$ |

* Specifications the same as OPA241UA, PA.

NOTES: (1) $V_S = +5V$. (2) The negative sign indicates input bias current flows out of the input terminals. (3) Output voltage swings are measured between the output and power supply rails.

The information provided herein is believed to be reliable; however, BURR-BROWN assumes no responsibility for inaccuracies or omissions. BURR-BROWN assumes no responsibility for the use of this information, and all use of such information shall be entirely at the user's own risk. Prices and specifications are subject to change without notice. No patent rights or licenses to any of the circuits described herein are implied or granted to any third party. BURR-BROWN does not authorize or warrant any BURR-BROWN product for use in life support devices and/or systems.

SPECIFICATIONS: $V_S = \pm 15V$

At $T_A = +25^\circ C$, $R_L = 100k\Omega$ connected to ground, unless otherwise noted.

Boldface limits apply over the specified temperature range, $T_A = -40^\circ C$ to $+85^\circ C$.

| PARAMETER | CONDITION | OPA241UA, PA OPA2241UA, PA OPA4241UA, PA | | | OPA251UA, PA OPA2251UA, PA OPA4251UA, PA | | | UNITS |
|--|---|--|---|-----|--|--|---|--|
| | | MIN | TYP | MAX | MIN | TYP | MAX | |
| OFFSET VOLTAGE Input Offset Voltage V_{OS} $T_A = -40^\circ C$ to $+85^\circ C$ vs Temperature dV_{OS}/dT vs Power Supply PSRR $T_A = -40^\circ C$ to $+85^\circ C$ Channel Separation (dual, quad) | $T_A = -40^\circ C$ to $+85^\circ C$ $V_S = \pm 1.35V$ to $\pm 18V$ $V_S = \pm 1.35V$ to $\pm 18V$ | | ± 100 ± 150 ± 0.6 * * | | | ± 50 ± 100 ± 0.5 3 0.3 | ± 250 ± 300 30 30 | μV μV $\mu V/^\circ C$ $\mu V/V$ $\mu V/V$ |
| INPUT BIAS CURRENT Input Bias Current ⁽¹⁾ I_B $T_A = -40^\circ C$ to $+85^\circ C$ Input Offset Current I_{OS} $T_A = -40^\circ C$ to $+85^\circ C$ | | | * | | | -4 ± 0.1 | -20 -25 ± 2 ± 2 | nA nA nA nA |
| NOISE Input Voltage Noise, $f = 0.1Hz$ to $10Hz$ Input Voltage Noise Density, $f = 1kHz$ e_n Current Noise Density, $f = 1kHz$ i_n | | | * | | | 1 45 40 | | $\mu Vp-p$ nV/\sqrt{Hz} fA/\sqrt{Hz} |
| INPUT VOLTAGE RANGE Common-Mode Voltage Range V_{CM} Common-Mode Rejection Ratio CMRR $T_A = -40^\circ C$ to $+85^\circ C$ | $V_{CM} = -15.2V$ to $14.2V$ $V_{CM} = -15V$ to $14.2V$ | | * | | (V-) -0.2 100 100 | 124 | (V+) -0.8 | V dB dB |
| INPUT IMPEDANCE Differential Common-Mode | | | * | | | $10^7 \parallel 2$ $10^9 \parallel 4$ | | $\Omega \parallel pF$ $\Omega \parallel pF$ |
| OPEN-LOOP GAIN Open-Loop Voltage Gain A_{OL} $T_A = -40^\circ C$ to $+85^\circ C$ $T_A = -40^\circ C$ to $+85^\circ C$ | $R_L = 100k\Omega$, $V_O = -14.75V$ to $+14.75V$ $R_L = 100k\Omega$, $V_O = -14.75V$ to $+14.75V$ $R_L = 20k\Omega$, $V_O = -14.7V$ to $+14.7V$ $R_L = 20k\Omega$, $V_O = -14.7V$ to $+14.7V$ | | * | | 100 100 100 100 | 128 128 | | dB dB dB dB |
| FREQUENCY RESPONSE Gain-Bandwidth Product GBW Slew Rate SR Overload Recovery Time | $G = 1$ $V_{IN} \cdot G = V_S$ | | * | | | 35 0.01 60 | | kHz V/ μs μs |
| OUTPUT Voltage Output Swing from Rail ⁽²⁾ V_O $T_A = -40^\circ C$ to $+85^\circ C$ $T_A = -40^\circ C$ to $+85^\circ C$ Short-Circuit Current I_{SC} Single Versions Dual Versions Capacitive Load Drive C_{LOAD} | $R_L = 100k\Omega$, $A_{OL} \geq 70dB$ $R_L = 100k\Omega$, $A_{OL} \geq 100dB$ $R_L = 100k\Omega$, $A_{OL} \geq 100dB$ $R_L = 20k\Omega$, $A_{OL} \geq 100dB$ $R_L = 20k\Omega$, $A_{OL} \geq 100dB$ | | * | | | 50 75 100 | 250 250 300 300 | mV mV mV mV mA mA |
| POWER SUPPLY Specified Voltage Range V_S Operating Voltage Range Quiescent Current (per amplifier) I_Q $T_A = -40^\circ C$ to $+85^\circ C$ | $T_A = -40^\circ C$ to $+85^\circ C$ $I_Q = 0$ $I_Q = 0$ | | * | | | ± 1.35 ± 15 ± 27 | ± 18 ± 38 ± 45 | V V μA μA |
| TEMPERATURE RANGE Specified Range Operating Range Storage Range Thermal Resistance θ_{JA} 8-Pin DIP SO-8 Surface Mount 14-Pin DIP SO-14 Surface Mount | | | * | | | -40 -55 -55 | +85 +125 +125 | $^\circ C$ $^\circ C$ $^\circ C$ $^\circ C/W$ $^\circ C/W$ $^\circ C/W$ $^\circ C/W$ |

* Specifications the same as OPA251UA, PA.

NOTES: (1) The negative sign indicates input bias current flows out of the input terminals. (2) Output voltage swings are measured between the output and power supply rails.

ABSOLUTE MAXIMUM RATINGS⁽¹⁾

| | |
|---|--------------------------|
| Supply Voltage, V+ to V- | 36V |
| Input Voltage ⁽²⁾ | (V-) -0.5V to (V+) +0.5V |
| Output Short Circuit to Ground ⁽³⁾ | Continuous |
| Operating Temperature | -55°C to +125°C |
| Storage Temperature | -55°C to +125°C |
| Junction Temperature | 150°C |
| Lead Temperature (soldering, 10s) | 300°C |

NOTES: (1) Stresses above these ratings may cause permanent damage.
 (2) Input terminals are diode-clamped to the power supply rails. Input signals that can swing more than 0.5V beyond the supply rails should be current-limited to 5mA or less. (3) One amplifier per package.



ELECTROSTATIC DISCHARGE SENSITIVITY

This integrated circuit can be damaged by ESD. Burr-Brown recommends that all integrated circuits be handled with appropriate precautions. Failure to observe proper handling and installation procedures can cause damage.

ESD damage can range from subtle performance degradation to complete device failure. Precision integrated circuits may be more susceptible to damage because very small parametric changes could cause the device not to meet its published specifications.

PACKAGE/ORDERING INFORMATION

| PRODUCT | SPECIFIED VOLTAGE | OPERATING VOLTAGE RANGE | PACKAGE | PACKAGE DRAWING NUMBER ⁽¹⁾ | SPECIFICATION TEMPERATURE RANGE |
|----------------------|-------------------|-------------------------|---------------------|---------------------------------------|---------------------------------|
| OPA241 SERIES | | | | | |
| Single | | | | | |
| OPA241PA | 2.7V to 5V | 2.7V to 36V | 8-Pin DIP | 006 | -40°C to +85°C |
| OPA241UA | 2.7V to 5V | 2.7V to 36V | SO-8 Surface Mount | 182 | -40°C to +85°C |
| Dual | | | | | |
| OPA2241PA | 2.7V to 5V | 2.7V to 36V | 8-Pin DIP | 006 | -40°C to +85°C |
| OPA2241UA | 2.7V to 5V | 2.7V to 36V | SO-8 Surface Mount | 182 | -40°C to +85°C |
| Quad | | | | | |
| OPA4241PA | 2.7V to 5V | 2.7V to 36V | 14-Pin DIP | 010 | -40°C to +85°C |
| OPA4241UA | 2.7V to 5V | 2.7V to 36V | SO-14 Surface Mount | 235 | -40°C to +85°C |
| OPA251 SERIES | | | | | |
| Single | | | | | |
| OPA251PA | ±15V | 2.7V to 36V | 8-Pin DIP | 006 | -40°C to +85°C |
| OPA251UA | ±15V | 2.7V to 36V | SO-8 Surface Mount | 182 | -40°C to +85°C |
| Dual | | | | | |
| OPA2251PA | ±15V | 2.7V to 36V | 8-Pin DIP | 006 | -40°C to +85°C |
| OPA2251UA | ±15V | 2.7V to 36V | SO-8 Surface Mount | 182 | -40°C to +85°C |
| Quad | | | | | |
| OPA4251PA | ±15V | 2.7V to 36V | 14-Pin DIP | 010 | -40°C to +85°C |
| OPA4251UA | ±15V | 2.7V to 36V | SO-14 Surface Mount | 235 | -40°C to +85°C |

NOTE: (1) For detailed drawing and dimension table, please see end of data sheet, or Appendix C of Burr-Brown IC Data Book.

TYPICAL PERFORMANCE CURVES

At $T_A = +25^\circ\text{C}$, and $R_L = 100\text{k}\Omega$ connected to $V_S/2$ (ground for $V_S = \pm 15\text{V}$), unless otherwise noted.

Curves apply to OPA241 and OPA251 unless specified.

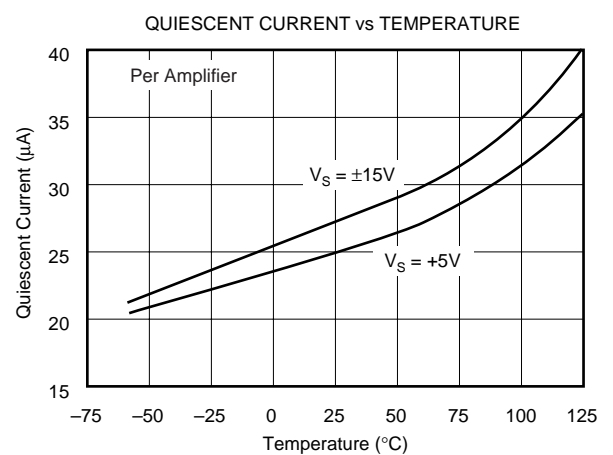
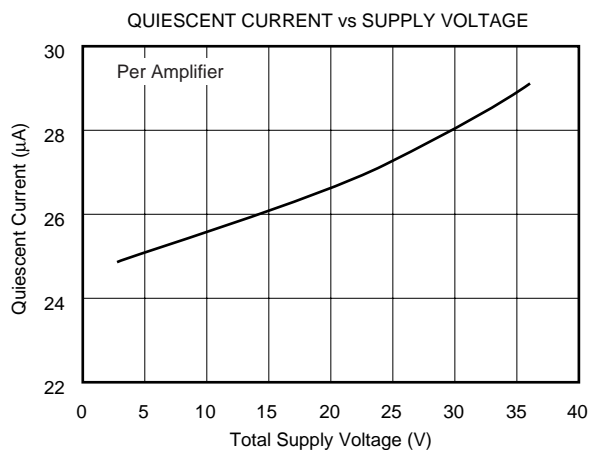
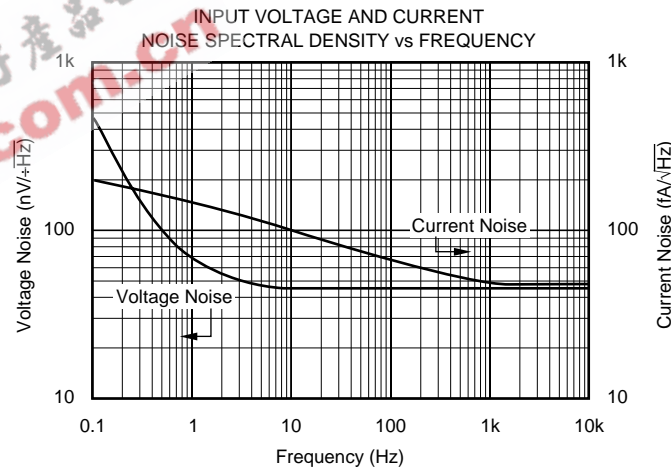
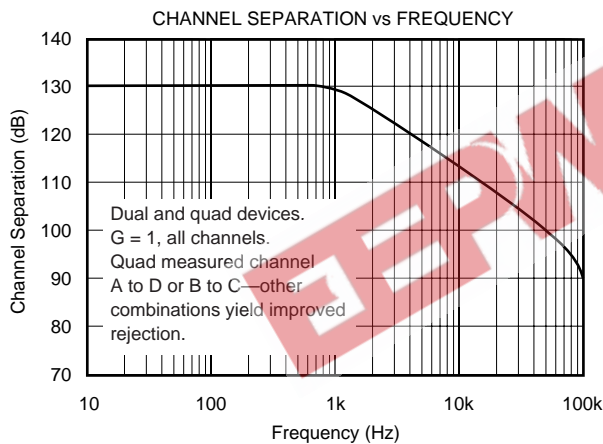
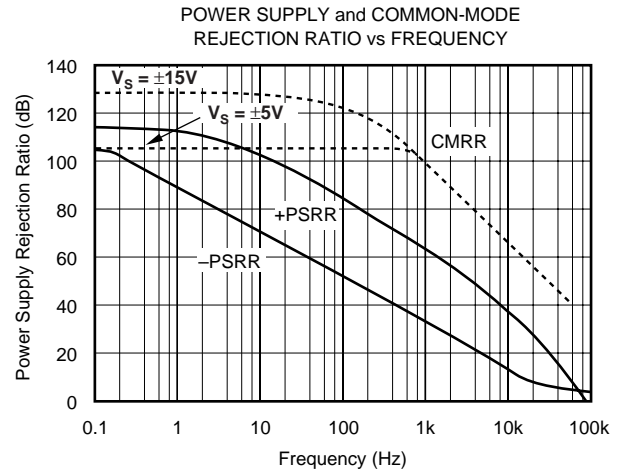
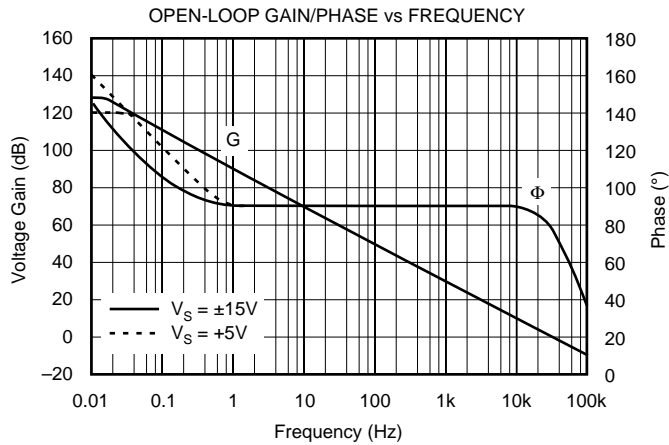

TYPICAL PERFORMANCE CURVES (CONT)

At $T_A = +25^\circ\text{C}$, and $R_L = 100\text{k}\Omega$ connected to $V_S/2$ (ground for $V_S = \pm 15\text{V}$), unless otherwise noted.

Curves apply to OPA241 and OPA251 unless specified.

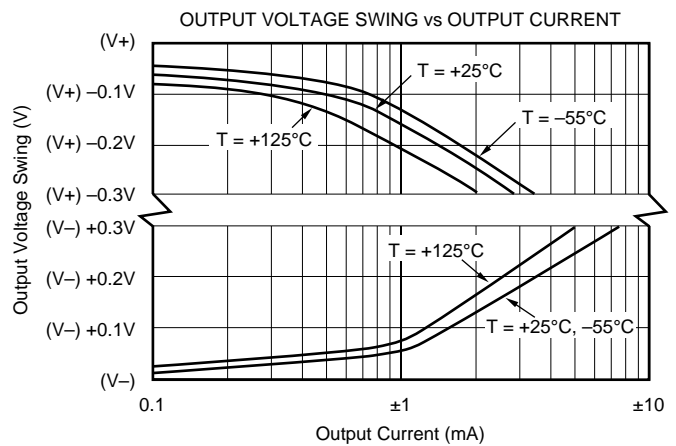
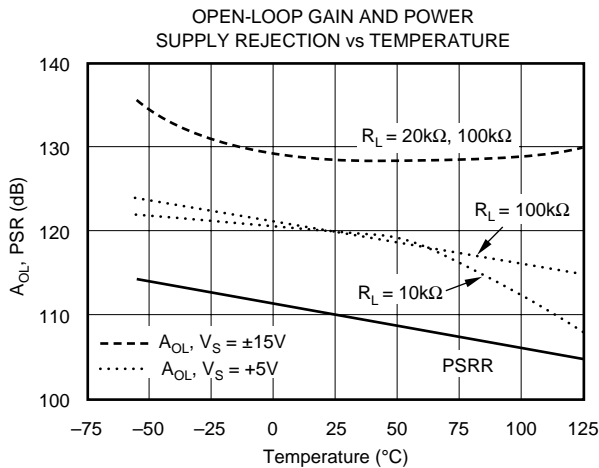
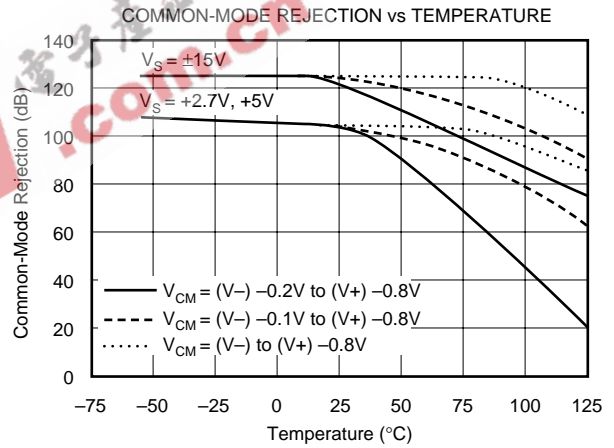
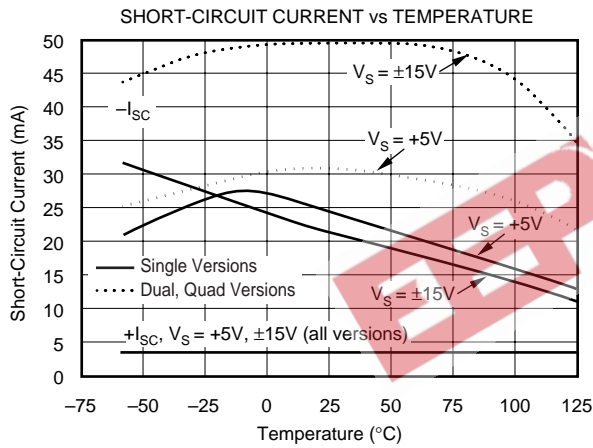
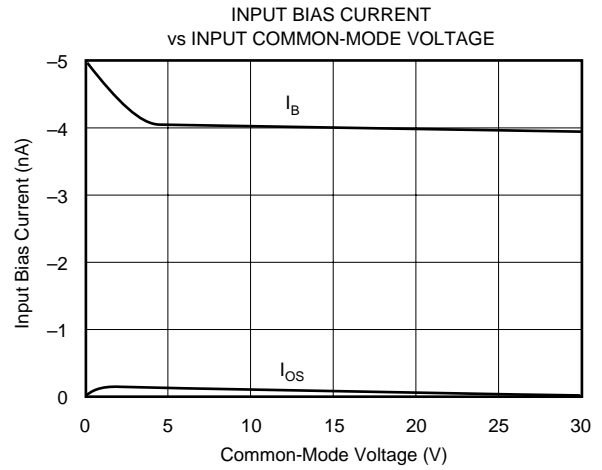
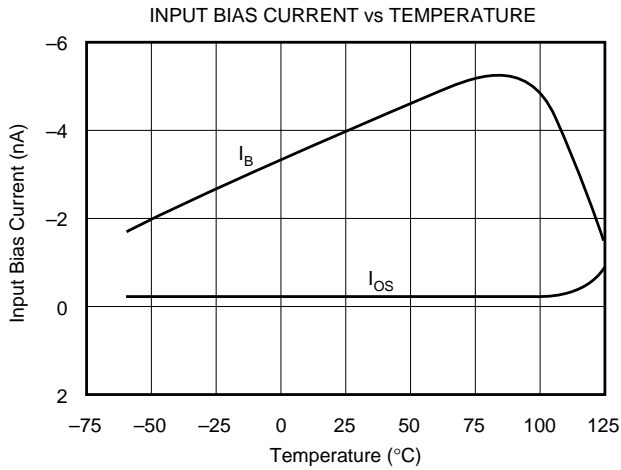

TYPICAL PERFORMANCE CURVES (CONT)

At $T_A = +25^\circ\text{C}$, and $R_L = 100\text{k}\Omega$ connected to $V_S/2$ (ground for $V_S = \pm 15\text{V}$), unless otherwise noted.

Curves apply to OPA241 and OPA251 unless specified.

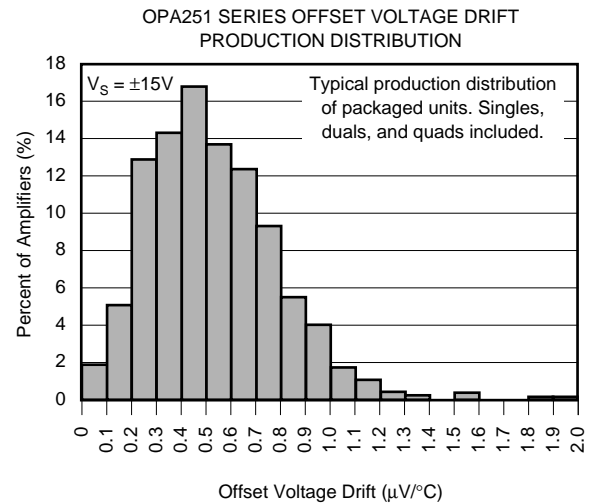
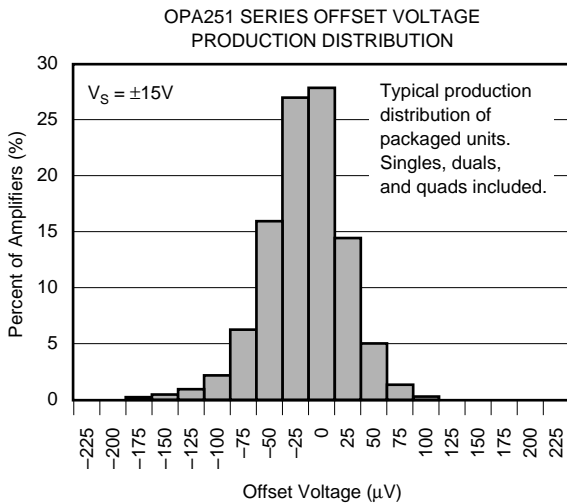
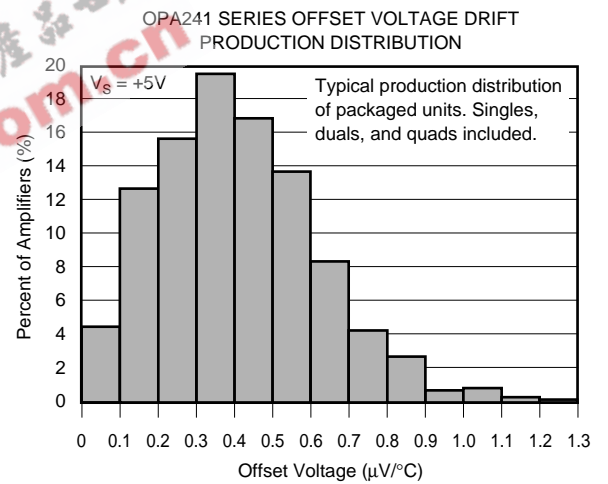
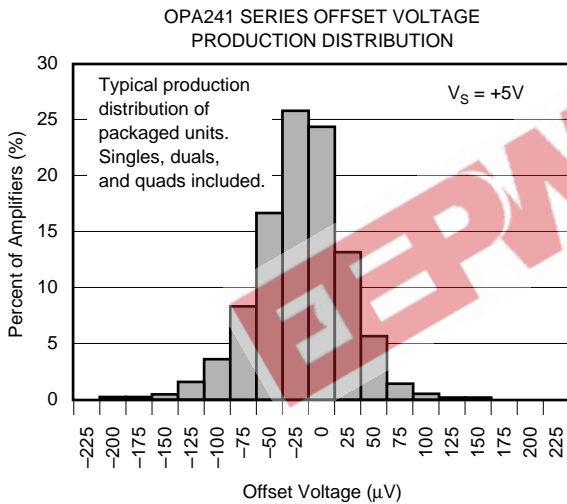
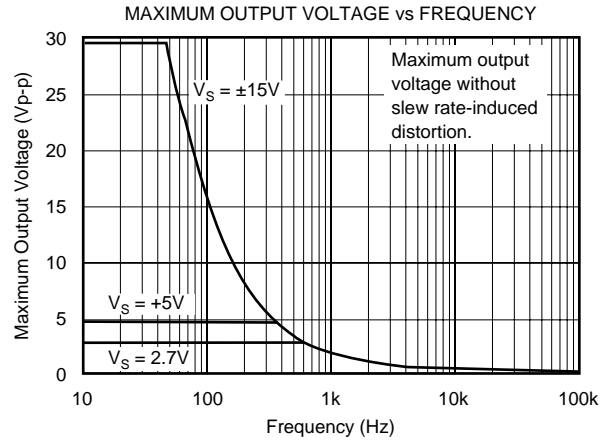
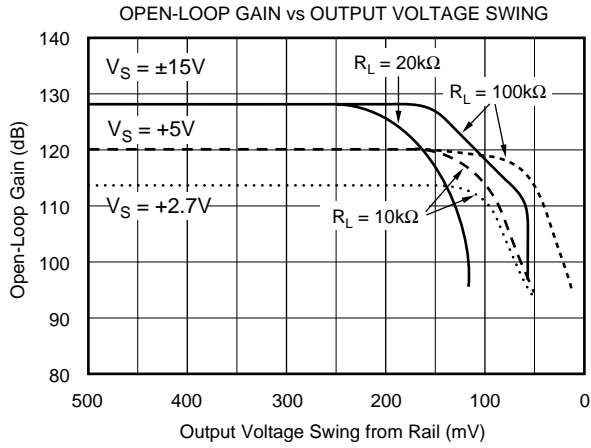

TYPICAL PERFORMANCE CURVES (CONT)

At $T_A = +25^\circ\text{C}$, and $R_L = 100\text{k}\Omega$ connected to $V_S/2$ (ground for $V_S \pm 15\text{V}$), unless otherwise noted.

Curves apply to OPA241 and OPA251 unless specified.

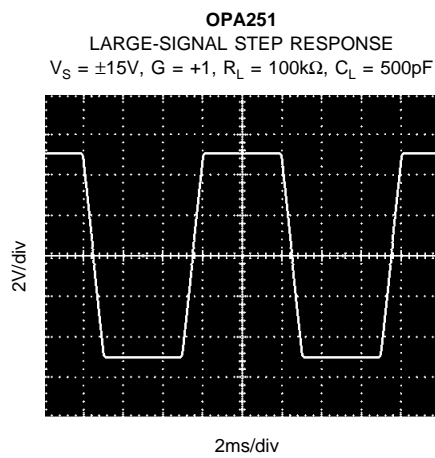
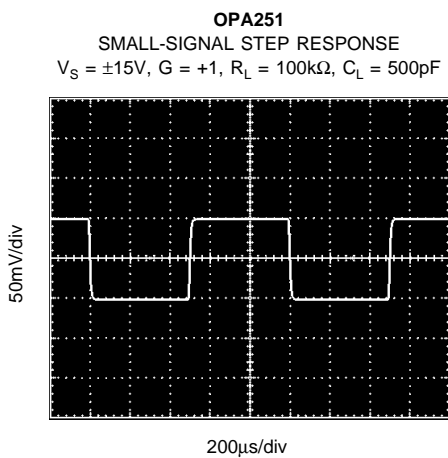
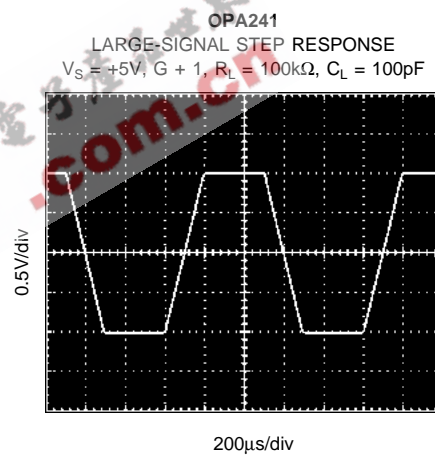
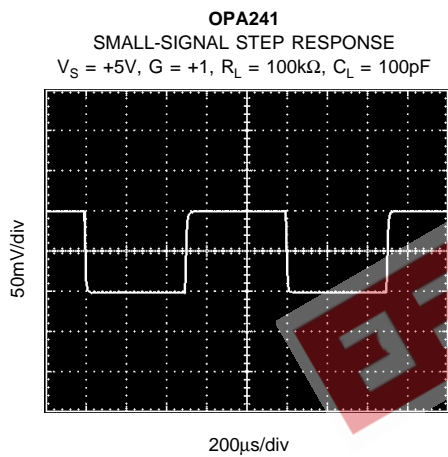
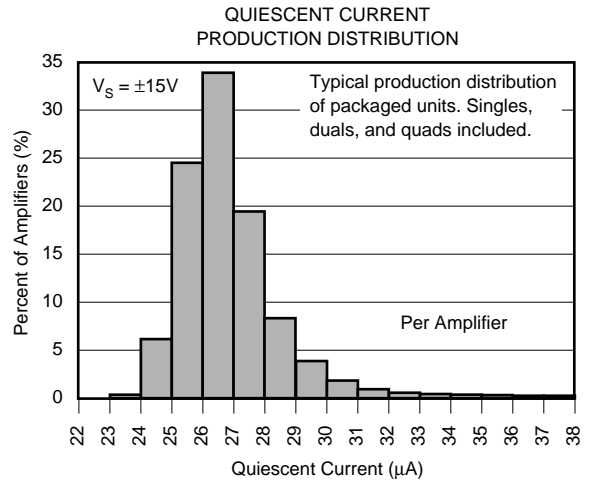
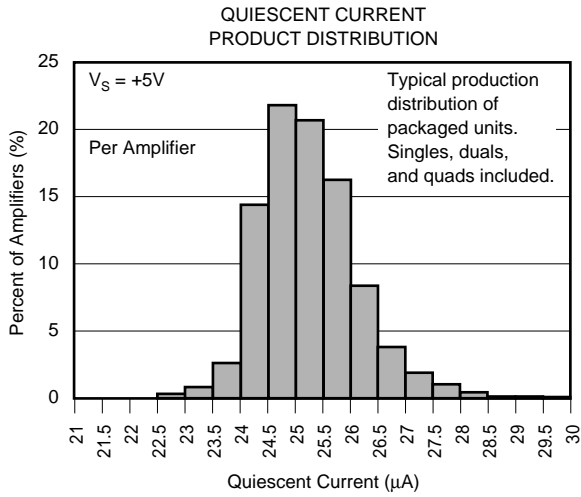

APPLICATIONS INFORMATION

The OPA241 and OPA251 series are unity-gain stable and suitable for a wide range of general purpose applications. Power supply pins should be bypassed with 0.01 μ F ceramic capacitors.

OPERATING VOLTAGE

The OPA241 series is laser-trimmed for low offset voltage and drift at low supply voltage ($V_S = +5V$). The OPA251 series is trimmed for $\pm 15V$ operation. Both products operate over the full voltage range (+2.7V to +36V or $\pm 1.35V$ to $\pm 18V$) with some compromises in offset voltage and drift performance. However, all other parameters have similar performance. Key parameters are guaranteed over the specified temperature range, $-40^\circ C$ to $+85^\circ C$. Most behavior remains unchanged throughout the full operating voltage range. Parameters which vary significantly with operating voltage or temperature are shown in typical performance curves.

OFFSET VOLTAGE TRIM

As mentioned previously, offset voltage of the OPA241 series is laser-trimmed at +5V. The OPA251 series is trimmed at $\pm 15V$. Because the initial offset is so low, user adjustment is usually not required. However, the OPA241 and OPA251 (single op amp versions) provide offset voltage trim connections on pins 1 and 5. Offset voltage can be adjusted by connecting a potentiometer as shown in Figure 1. This adjustment should be used only to null the offset of the op amp, not to adjust system offset or offset produced by the signal source. Nulling offset could degrade the offset drift behavior of the op amp. While it is not possible to predict the exact change in drift, the effect is usually small.

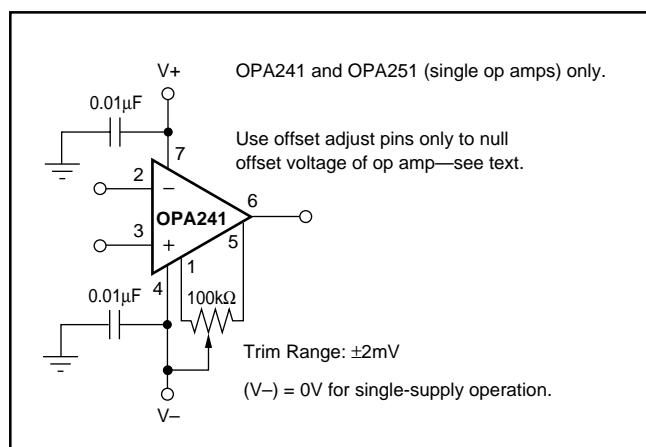

FIGURE 1. OPA241 and OPA251 Offset Voltage Trim Circuit.

CAPACITIVE LOAD AND STABILITY

The OPA241 series and OPA251 series can drive a wide range of capacitive loads. However, all op amps under certain conditions may be unstable. Op amp configuration, gain, and load value are just a few of the factors to consider when determining stability.

Figures 2 and 3 show the regions where the OPA241 series and OPA251 series have the potential for instability. As shown, the unity gain configuration with low supplies is the most susceptible to the effects of capacitive load. With $V_S = +5V$, $G = +1$, and $I_{OUT} = 0$, operation remains stable with load capacitance up to approximately 200pF. Increasing supply voltage, output current, and/or gain significantly improves capacitive load drive. For example, increasing the supplies to $\pm 15V$ and gain to 10 allows approximately 2700pF to be driven.

One method of improving capacitive load drive in the unity gain configuration is to insert a resistor inside the feedback loop as shown in Figure 4. This reduces ringing with large capacitive loads while maintaining dc accuracy. For example, with $V_S = \pm 1.35V$ and $R_S = 5k\Omega$, the OPA241 series and OPA251 series perform well with capacitive loads in excess of 1000pF. Without the series resistor, capacitive load drive is typically 200pF for these conditions. However, this method will result in a slight reduction of output voltage swing.

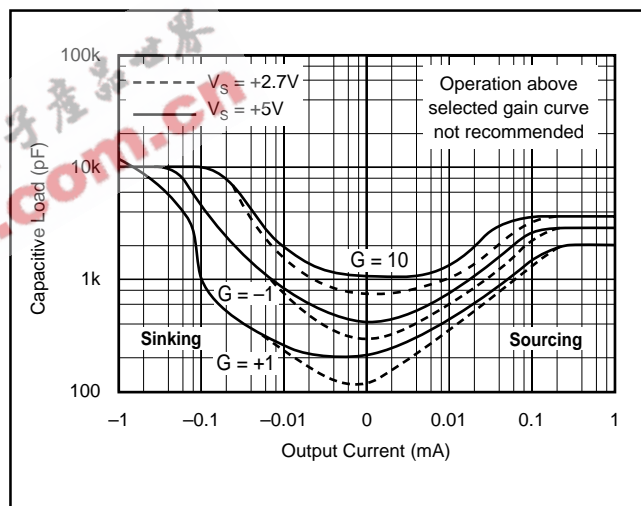

FIGURE 2. Stability—Capacitive Load versus Output Current for Low Supply Voltage.

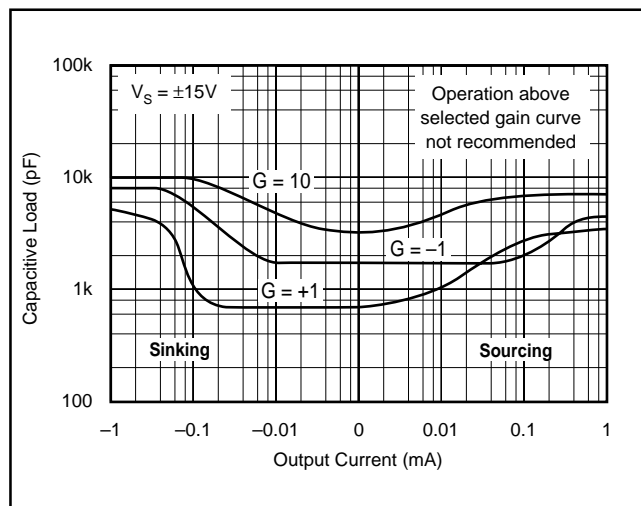

FIGURE 3. Stability—Capacitive Load versus Output Current for $\pm 15V$ Supplies.

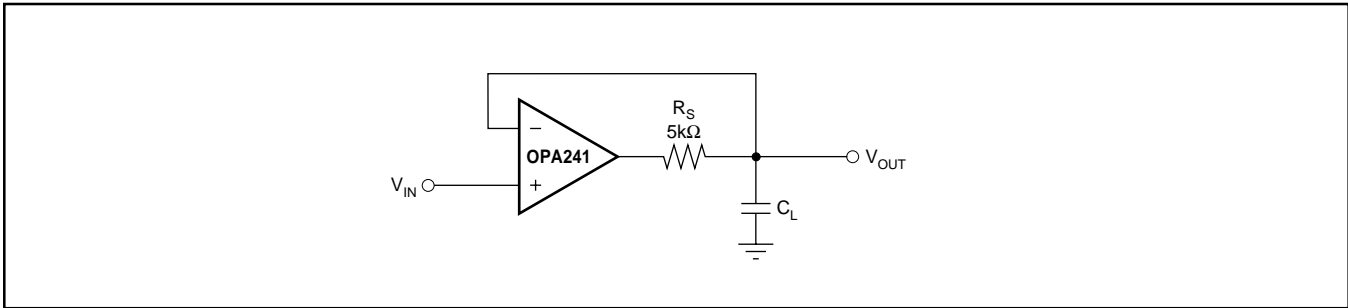

FIGURE 4. Series Resistor in Unity Gain Configuration Improves Capacitive Load Drive.

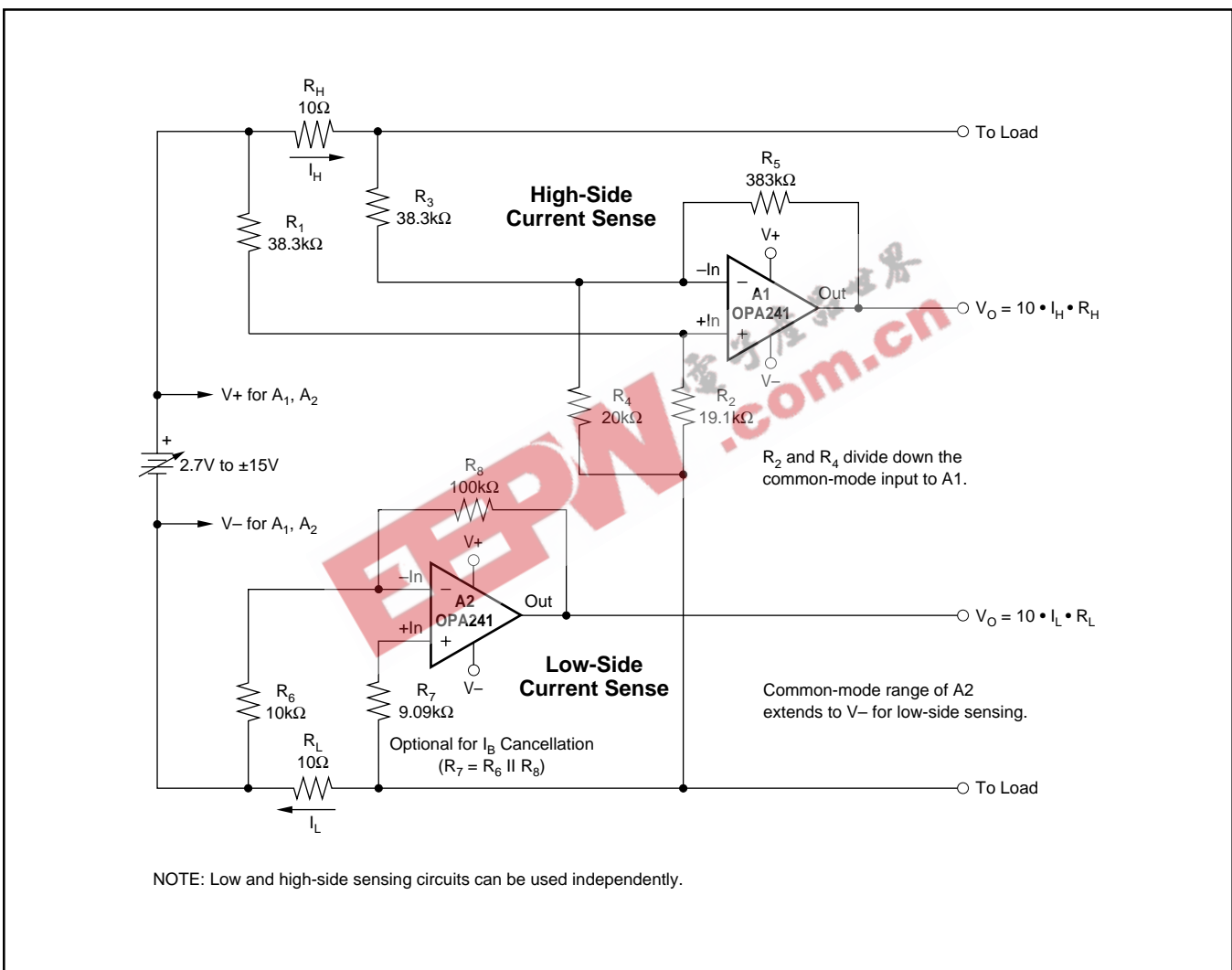

FIGURE 5. Low and High-Side Battery Current Sensing.