

Photologic® Slotted Optical Switch

Types OPB615, OPB616, OPB617, OPB618

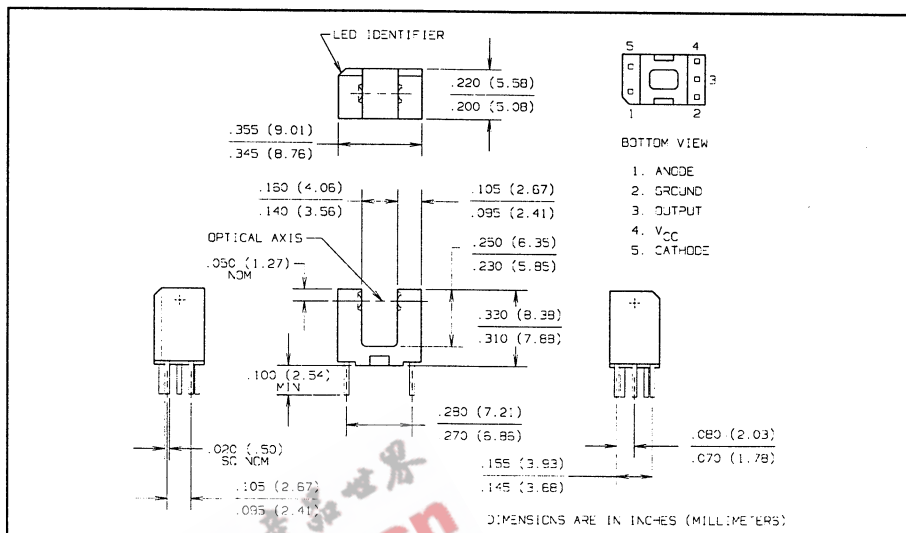
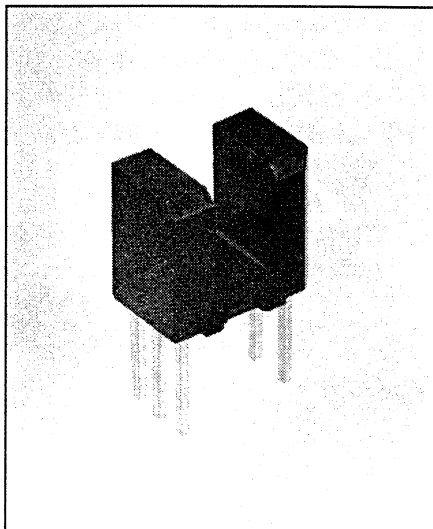

Features

- Non-contact switching
- Printed circuit board mounting
- 0.275" (6.99 mm) Lead centers
- 0.150" (3.81 mm) Gap
- Enhanced signal to noise ratio
- Four output options

Description

The OPB615 series slotted optical switches consist of an infrared emitting diode and a monolithic integrated circuit which incorporates a photodiode, a linear amplifier and a Schmitt trigger on a single silicon chip.

The sensors feature TTL/LSTTL compatible logic level output. Open collector output versions can drive up to 10 TTL loads over a voltage range from 4.5 V to 16 V.

Absolute Maximum Ratings (T_A = 25° C unless otherwise noted)

Storage Temperature Range	-40° C to +100° C
Operating Temperature Range	-40° C to +100° C
Lead Soldering Temperature [1/16 inch (1.6 mm) from case for 5 sec. with soldering iron]	240° C ⁽¹⁾

Input Diode

Forward DC Current	50 mA
Peak Forward Current (1µs pulse width, 300 pps)	3.0 A
Reverse DC Voltage	3.0 V
Power Dissipation	100 mW ⁽²⁾

Output Photologic®

Supply Voltage, V _{CC}	18 V
Duration of Output Short To V _{CC}	1.0 sec
Voltage at Output	30 V
Low Level Output Current (sinking)	16 mA
Power Dissipation	240 mW ⁽³⁾

Notes:

- (1) RMA flux is recommended. Duration can be extended to 10 sec. max. when flow soldering.
- (2) Derate linearly 1.33 mW/° C above 25° C.
- (3) Derate linearly 2.50 mW/° C above 30° C.

Schematics

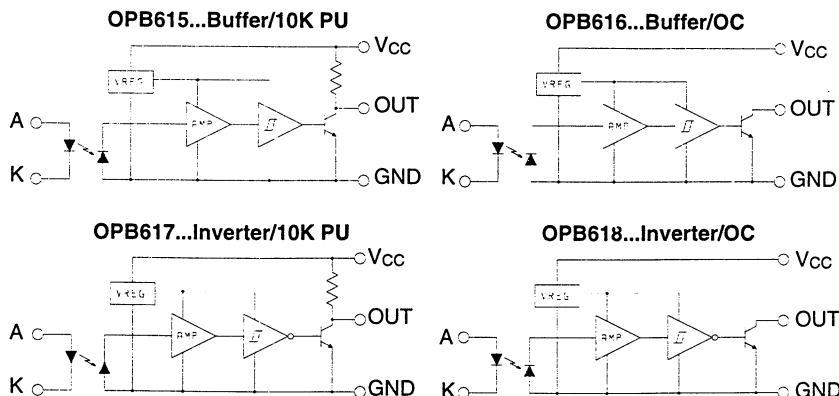

Types OPB615, OPB616, OPB617, OPB618

Electrical Characteristics ($T_A = 25^\circ\text{C}$, $V_{CC} = 4.5\text{ V to }16\text{ V}$ unless otherwise noted)

SYMBOL	PARAMETER	MIN	TYP	MAX	UNITS	TEST CONDITIONS
Input Diode						
V_F	Forward Voltage			1.6	V	$I_F = 10\text{ mA}$
I_R	Reverse Current			100	μA	$V_R = 3.0\text{ V}$
Output Photologic[®] Sensor						
V_{CC}	Operating DC Supply Voltage	4.5		16.0	V	
$I_{F(+)}$	LED Positive-Going Threshold Current	0.1	0.55	3.0	mA	
$I_{F(+)} / I_{F(-)}$	Hysteresis Ratio	1.05	1.20	1.60		
I_{CCH}	High Level Supply Current:					
	Buffer, 10K Pull-up OPB615 Buffer, Open-Collector OPB616		5.0	12.0	mA	$I_F = 5\text{ mA}$, No Load On Output
	Inverter, 10K Pull-up OPB617 Inverter, Open-Collector OPB618		4.0	12.0	mA	$I_F = 0\text{ mA}^{(4)}$, No Load On Output
	I_{CCL}	Low Level Supply Current:				
	Buffer, 10K Pull-up OPB615 Buffer, Open-Collector OPB616		5.5	12.0	mA	$I_F = 0\text{ mA}^{(4)}$, No Load On Output
	Inverter, 10K Pull-up OPB617 Inverter, Open-Collector OPB618		6.5	12.0	mA	$I_F = 5\text{ mA}$, No Load On Output
V_{OH}	High Level Output Voltage:					
	Buffer, 10K Pull-up OPB615 Inverter, 10K Pull-up OPB617	$(V_{CC}-1.5)$			V	$I_F = 5\text{ mA}$, $I_{OH} = 100\text{ }\mu\text{A}$
I_{OH}	High Level Output Current:					
	Buffer, Open-Collector OPB616 Inverter, Open-Collector OPB618			100	μA	$I_F = 5\text{ mA}$, $V_{OH} = 30\text{ V}$
V_{OL}	Low Level Output Voltage:					
	Buffer, 10K Pull-up OPB615 Buffer, Open-Collector OPB616			0.4	V	$I_F = 0\text{ mA}^{(4)}$, $I_{OL} = 16\text{ mA}$
	Inverter, 10K Pull-up OPB617 Inverter, Open-Collector OPB618			0.4	V	$I_F = 5\text{ mA}$, $I_{OL} = 16\text{ mA}$
	t_r, t_f	Output Rise Time, Output Fall Time		30	ns	
t_{PLH}	Propagation Delay, Low-High					
	Buffer, 10K Pull-up OPB615 Buffer, Open-Collector OPB616		0.6		μs	$I_F = 0\text{ or }5\text{ mA}$, $f = 10\text{ kHz}$, DC = 50%, $R_L = 300\text{ }\Omega$
Inverter, 10K Pull-up OPB617 Inverter, Open-Collector OPB618		3.0		μs		
t_{PHL}	Propagation Delay, High-Low					
	Buffer, 10K Pull-up OPB615 Buffer, Open-Collector OPB616		3.0		μs	
	Inverter, 10K Pull-up OPB617 Inverter, Open-Collector OPB618		0.6		μs	
	Data Rate	Data Rate		100	kHz	$I_F = 0\text{ or }5\text{ mA}$, D.C. = 50%, $R_L = 300\text{ }\Omega$

(4) Normal application would be with light source blocked, simulated by $I_F = 0\text{ mA}$.

SLOTTED OPTICAL

Typical Performance Curves

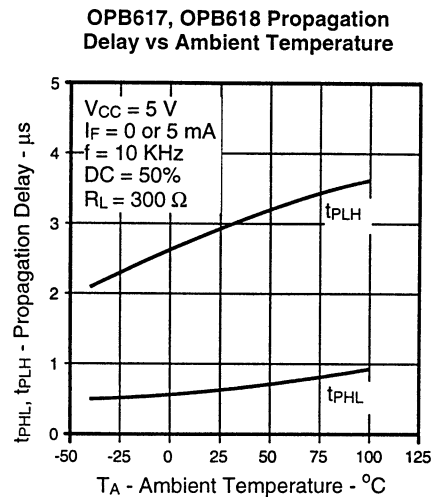
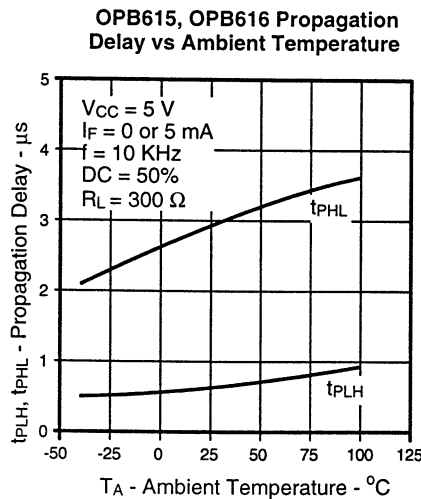
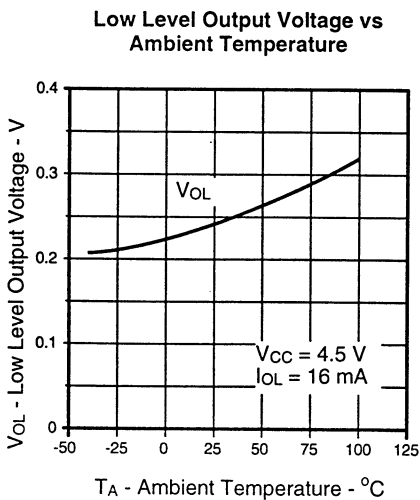
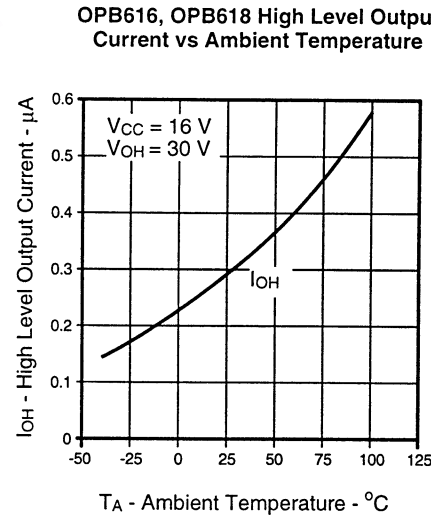
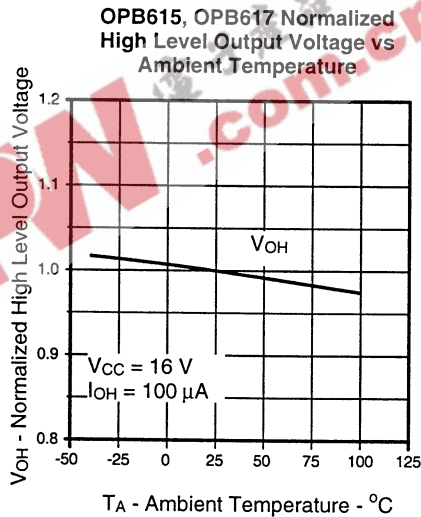
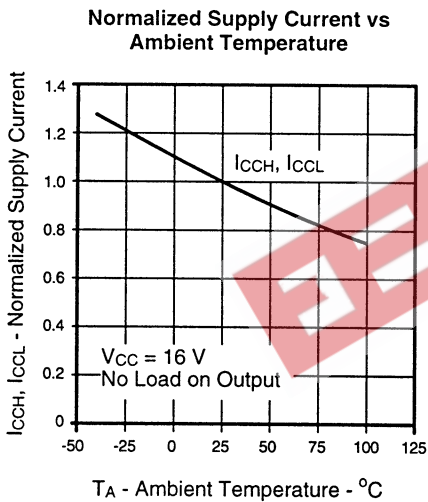
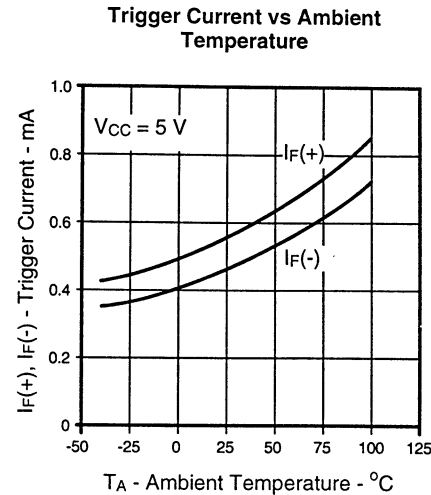
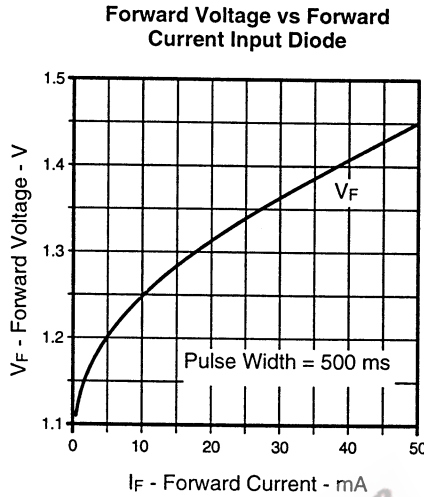
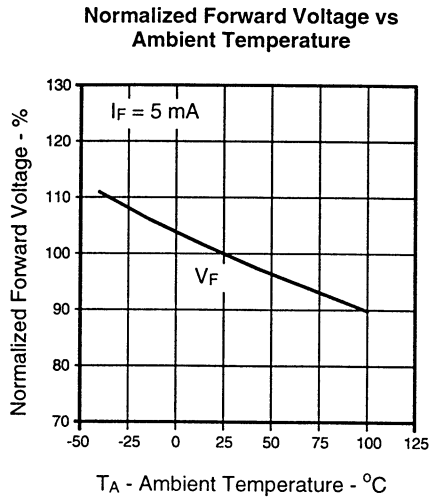

Types OPB615, OPB616, OPB617, OPB618

Typical Performance Curves

Rise Time and Fall Time vs Ambient Temperature

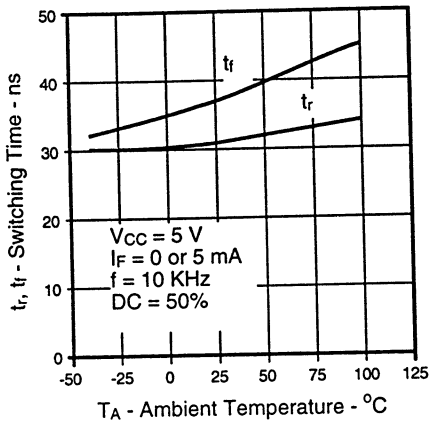

Rise Time vs Output Load vs Ambient Temperature

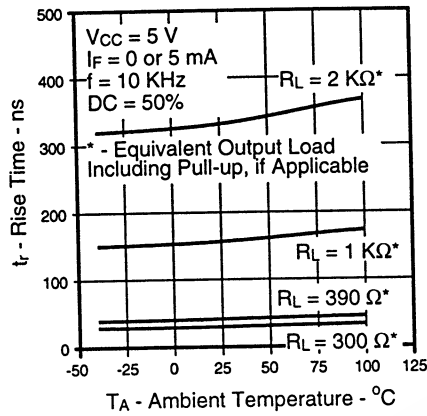

Maximum Data Rate vs Ambient Temperature

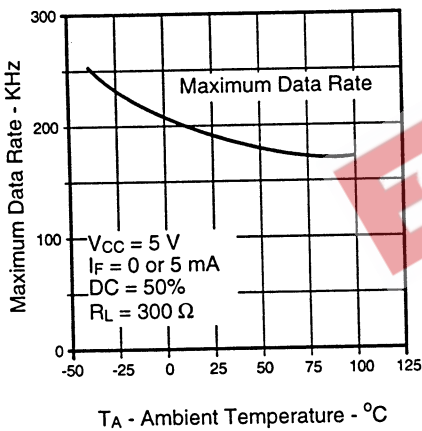

Typical Thermal Derating Curve

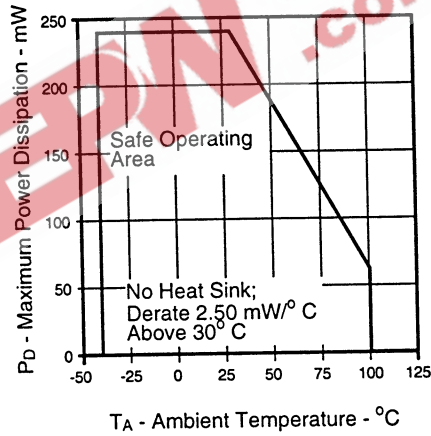

SLOTTED
OPTICAL
SWITCHES