

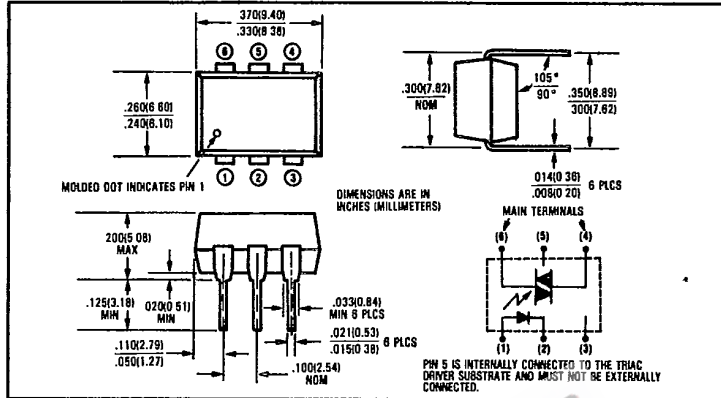

T-41-87

Optically Coupled Triac Drivers

Types OPI3020, OPI3021, OPI3022, OPI3023

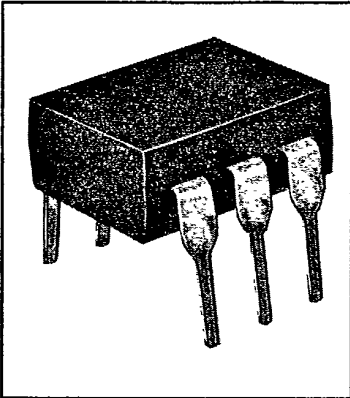

Features

- For 220 VAC operation
- 2500 VDC minimum electrical isolation
- Low LED trigger current to latch output
- UL recognized File No. E58730

Description

The OPI3020, OPI3021, OPI3022, and OPI3023 each consist of a gallium arsenide or gallium aluminum arsenide infrared emitting diode and a monolithic integrated circuit containing a photo-diode and a bidirectional switch, mounted in a standard plastic six pin dual-in-line package. This series is intended to interface electronic controls with power triacs to control resistive and inductive loads as in motors, solenoids, and appliances.

Absolute Maximum Ratings (T_A = 25°C unless otherwise noted)

Input-to-Output Isolation Voltage	±2500 VDC ⁽¹⁾
Storage Temperature Range	-40°C to +150°C
Operating Temperature Range	-40°C to +85°C
Lead Soldering Temperature (1/16 inch (1.6 mm) from case for 5 sec. with soldering iron) ⁽²⁾	260°C
Total Device Power Dissipation	400 mW ⁽³⁾
Input Diode	
Forward DC Current	I _F 60 mA
Reverse DC Voltage	V _R 3.0 V
Power Dissipation	P _D 100 mW ⁽⁴⁾
Output Photosensor	
Off-State Terminal Voltage	V _{DRM} 400 V
On-State RMS Current	I _T (RMS) [Full Cycle] T _A = 25°C 100 mA
	[50-60 Hz] T _A = 70°C 50 mA
Peak Non-Repetitive Surge Current (PW = 10 ms, duty cycle = 10%)	I _{TSM} 1.20 A
Power Dissipation	P _D 350 mW ⁽⁵⁾

Notes:

- (1) Measured with input diode leads shorted together and output leads shorted together.
- (2) RMA flux is recommended. Duration can be extended to 10 sec. max. when flow soldering.
- (3) Derate 7.27 mW/°C above 25°C.
- (4) Derate 1.82 mW/°C above 25°C.
- (5) Derate 0.36 mW/°C above 25°C.

Typical Performance Curves

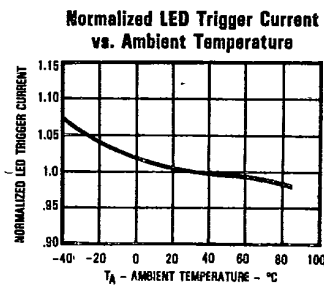
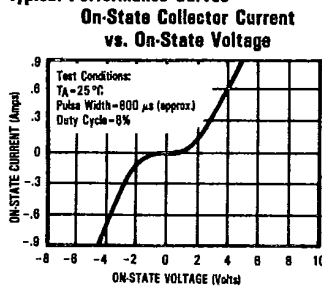

Types OPI3020, OPI3021, OPI3022, OPI3023

T-41-87

Electrical Characteristics (T_A = 25°C unless otherwise noted)

Symbol	Parameter	Min.	Typ.	Max.	Units	Test Conditions
Input Diode						
V _F	Forward Voltage		1.20	1.60	V	I _F = 10.0 mA
			1.40	1.70	V	I _F = 30 mA
I _R	Reverse Current		.0100	100	μA	V _R = 3.0 V
Output Photosensor						
I _{DRM}	Peak Blocking Current, Either Direction		10.0	100	nA	V _{DRM} = 400 V. Must be applied within dV/dt rating
V _{TM}	Peak On-State Voltage, Either Direction		1.75	3.0	V	I _{TM} = 100 mA
dV/dt	Critical Rate of Rise of Off-State Voltage		16.0		V/μs	R _L = 1 kΩ
dV/dt	Critical Rate of Rise of Commutating Voltage		.140		V/μs	R _L = 4 kΩ
Coupled						
I _{FT}	LED Trigger Current Required to Latch Output in Either Direction		15.0	30	mA	Main Terminal Voltage = 3.0 V
	OPI3020		10.0	15.0	mA	Main Terminal Voltage = 3.0 V
	OPI3021		7.5	10.0	mA	Main Terminal Voltage = 3.0 V
	OPI3022		3.5	5.0	mA	Main Terminal Voltage = 3.0 V
	OPI3023					Main Terminal Voltage = 3.0 V
I _H	Holding Current, Either Direction		100		μA	



Typical Performance Curves

Static dV/dt Test Circuit

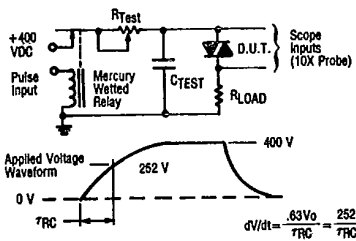

Commutating dV/dt Test Circuit

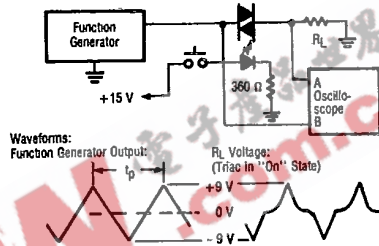

- The relay provides a high speed repeated pulse to the D.U.T.
- 10X probes are used to allow high speeds and voltages.
- The worst case condition for static dV/dt is established by triggering the D.U.T. with a normal input (LED) current, then removing this current. The variable R_{TEST} allows the dV/dt to be increased until the D.U.T. continues to trigger in response to the applied voltage pulse, even after the LED current has been removed. The dV/dt is then decreased until the D.U.T. stops triggering. 7RC is measured at this point and recorded.

- 10X probes are used to allow high speeds.
- Frequency is increased until the triac stays "on" after being triggered by pushbutton. Frequency is then decreased until triac turns "off." t_p is measured at this point and recorded.
- Commutating dV/dt = 36/t_p.

Static dV/dt vs. Ambient Temperature and Load Resistance

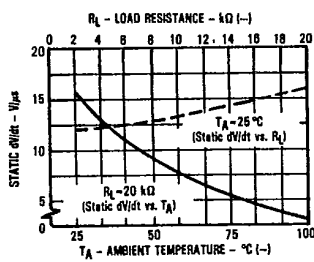

Commutating dV/dt vs. Ambient Temperature and Load Resistance

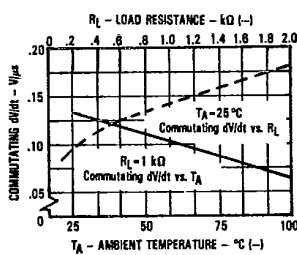

TRW reserves the right to make changes at any time in order to improve design and to supply the best product possible. Plastic color may vary.
 Optoelectronics Division, TRW Electronic Components Group, 1215 W. Crosby Rd., Carrollton, TX 75006 (214) 323-2200, TLX 6718032 or 215849
 © TRW Inc. 1985. TRW is the name and mark of TRW Inc. Printed in U.S.A.