

OPA551 OPA552

For most current data sheet and other product information, visit www.burr-brown.com

High-Voltage, High-Current OPERATIONAL AMPLIFIERS

FEATURES

- **WIDE SUPPLY RANGE:** $\pm 4V$ to $\pm 30V$
- **HIGH OUTPUT CURRENT:** 200mA Continuous
- **LOW NOISE:** $14nV/\sqrt{Hz}$
- **FULLY PROTECTED:**
Thermal Shutdown
Output Current-Limited
- **THERMAL SHUTDOWN INDICATOR**
- **WIDE OUTPUT SWING:** 2V From Rail
- **FAST SLEW RATE:**
OPA551: $15V/\mu s$
OPA552: $24V/\mu s$
- **WIDE BANDWIDTH:**
OPA551: 3MHz
OPA552: 12MHz
- **PACKAGES:** DIP-8, SO-8, or DDPAK-7

APPLICATIONS

- TELEPHONY
- TEST EQUIPMENT
- AUDIO AMPLIFIER
- TRANSDUCER EXCITATION
- SERVO DRIVER

DESCRIPTION

The OPA551 and OPA552 are low cost op amps with high-voltage (60V) and high-current (200mA) capability.

The OPA551 is unity-gain stable and features high slew rate ($15V/\mu s$) and wide bandwidth (3MHz). The OPA552 is optimized for gains of 5 or greater, and offers higher speed with a slew rate of $24V/\mu s$ and a bandwidth of 12MHz. Both are suitable for telephony, audio, servo, and test applications.

These laser-trimmed, monolithic integrated circuits provide excellent low-level accuracy along with high output swing. High performance is maintained as the amplifier swings to its specified limits.

The OPA551 and OPA552 are internally protected against over-temperature conditions and current overloads. The thermal shutdown indicator "flag" provides a current output to alert the user when thermal shutdown has occurred.

The OPA551 and OPA552 are available in DIP-8 and SO-8 packages, as well as a DDPAK-7 surface-mount plastic power package. They are specified for operation over the extended industrial temperature range, $-40^{\circ}C$ to $+125^{\circ}C$.

OPA551, OPA552

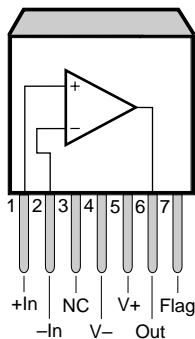

NOTE: Tab is connected to $V-$ supply.

DDPAK-7 Surface-Mount (F)

OPA551, OPA552

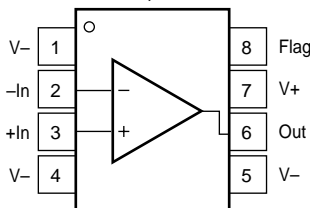

SO-8 (U)

OPA551, OPA552

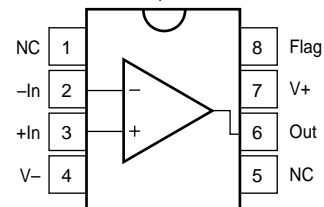

DIP-8 (P)

SPECIFICATIONS: $V_S = \pm 30V$

OPA552

At $T_J = +25^\circ\text{C}^{(1)}$, $R_L = 3\text{k}\Omega$ connected to Ground and $V_{OUT} = 0V$, unless otherwise noted.
Boldface limits apply over the specified junction temperature range, $T_J = -40^\circ\text{C}$ to $+125^\circ\text{C}$.

PARAMETER	CONDITION	OPA552UA, PA, FA			UNITS
		MIN	TYP	MAX	
OFFSET VOLTAGE Input Offset Voltage $T_J = -40^\circ\text{C}$ to $+125^\circ\text{C}$ vs Temperature vs Power Supply	V_{OS} dV_{OS}/dT PSRR $V_{CM} = 0V, I_O = 0$ $V_S = \pm 4V$ to $\pm 30V, V_{CM} = 0V$		± 1 ± 7 10	± 3 ± 5 30	mV mV $\mu\text{V}/^\circ\text{C}$ $\mu\text{V}/V$
INPUT BIAS CURRENT Input Bias Current Input Offset Current	I_B I_{OS}		± 20 ± 3	± 100 ± 100	pA pA
NOISE Input Voltage Noise Density, $f = 1\text{kHz}$ Current Noise Density, $f = 1\text{kHz}$	e_n i_n		14 3.5		$\text{nV}/\sqrt{\text{Hz}}$ $\text{fA}/\sqrt{\text{Hz}}$
INPUT VOLTAGE RANGE Common-Mode Voltage Range Common-Mode Rejection Ratio	V_{CM} CMRR $-27.5V < V_{CM} < +27.5V$	$(V-) + 2.5$ 92	102	$(V+) - 2.5$	V dB
INPUT IMPEDANCE Differential Common-Mode			$10^{13} \parallel 2$ $10^{13} \parallel 6$		$\Omega \parallel \text{pF}$ $\Omega \parallel \text{pF}$
OPEN-LOOP GAIN Open-Loop Voltage Gain $T_J = -40^\circ\text{C}$ to $+125^\circ\text{C}$	A_{OL} $R_L = 3\text{k}\Omega, -28V < V_O < +28V$ $R_L = 3\text{k}\Omega, -28V < V_O < +28V$ $R_L = 300\Omega, -27V < V_O < +27V$	110 100	126 120		dB dB dB
FREQUENCY RESPONSE Gain-Bandwidth Product Slew Rate Settling Time: 0.1% 0.01% Total Harmonic Distortion + Noise, $f = 1\text{kHz}$ THD+N Overload Recovery Time	GBW SR THD+N $V_{IN} \cdot \text{Gain} = V_S$		12 ± 24 2.2 3 0.0005 0.0005 1		MHz V/ μs μs μs % % μs
OUTPUT Voltage Output $T_J = -40^\circ\text{C}$ to $+125^\circ\text{C}$ $T_J = -40^\circ\text{C}$ to $+125^\circ\text{C}$ Maximum Continuous Current Output: dc Short-Circuit Current Capacitive Load Drive	V_{OUT} I_O I_{SC} C_{LOAD} Stable Operation	$(V-) + 3.0$ $(V-) + 3.5$ $(V-) + 2.0$ $(V-) + 2.5$ ± 200	± 380 See Typical Curve	$(V+) - 3.0$ $(V+) - 3.5$ $(V+) - 2.0$ $(V+) - 2.7$	V V V V mA mA
SHUTDOWN FLAG Thermal Shutdown Status Output Normal Operation Thermally Shutdown Voltage Compliance Range Junction Temperature Shutdown Reset from Shutdown		Sourcing Sourcing 80 V-	0.05 120 160 140	1 160 $(V+) - 1.5$	μA μA V $^\circ\text{C}$ $^\circ\text{C}$
POWER SUPPLY Specified Voltage Operating Voltage Range Quiescent Current $T_J = -40^\circ\text{C}$ to $+125^\circ\text{C}$	V_S I_Q $I_O = 0$	± 4	± 30 ± 7	± 30 ± 8.5 ± 10	V V mA mA
TEMPERATURE RANGE Specified Range Operating Range Storage Range Thermal Resistance SO-8 Surface Mount DIP-8 DDPak-7 DDPak-7	T_J T_J T_A θ_{JA} θ_{JA} θ_{JA} θ_{JC}	-40 -55 -65		+125 +125 +150 90 100 65 3	$^\circ\text{C}$ $^\circ\text{C}$ $^\circ\text{C}$ $^\circ\text{C}/W$ $^\circ\text{C}/W$ $^\circ\text{C}/W$ $^\circ\text{C}/W$

NOTES: (1) All tests are high-speed tested at $+25^\circ\text{C}$ ambient temperature. Effective junction temperature is $+25^\circ\text{C}$ unless otherwise noted.

ABSOLUTE MAXIMUM RATINGS⁽¹⁾

Output Current	See SOA Curve
Supply Voltage, V+ to V-	60V
Input Voltage Range	(V-) - 0.5V to (V+) + 0.5V
Operating Temperature	-55°C to +125°C
Storage Temperature	-65°C to +150°C
Junction Temperature	+150°C
Lead Temperature (soldering 10s, DIP-8)	300°C
(soldering 3s, SO-8 and DDPAK)	240°C
ESD Capability (Human Body Model).....	3000V

NOTE: (1) Stresses above these ratings may cause permanent damage. Exposure to absolute maximum conditions for extended periods may degrade device reliability.



ELECTROSTATIC DISCHARGE SENSITIVITY

This integrated circuit can be damaged by ESD. Burr-Brown recommends that all integrated circuits be handled with appropriate precautions. Failure to observe proper handling and installation procedures can cause damage.

ESD damage can range from subtle performance degradation to complete device failure. Precision integrated circuits may be more susceptible to damage because very small parametric changes could cause the device not to meet its published specifications.

PACKAGE/ORDERING INFORMATION

PRODUCT	PACKAGE	PACKAGE DRAWING NUMBER ⁽¹⁾	SPECIFIED TEMPERATURE RANGE	PACKAGE MARKING	ORDERING NUMBER ⁽²⁾	TRANSPORT MEDIA
OPA551UA	SO-8	182	-40°C to +125°C	OPA551UA	OPA551UA	Rails
"	"	"	"	"	OPA551UA/2K5	Tape and Reel
OPA551PA	DIP-8	006	-40°C to +125°C	OPA551PA	OPA551PA	Rails
OPA551FA	DDPAK-7	328	-40°C to +125°C	OPA551FA	OPA551FA	Rails
"	"	"	"	"	OPA551FA/500	Tape and Reel
OPA552UA	SO-8	182	-40°C to +125°C	OPA552UA	OPA552UA	Rails
"	"	"	"	"	OPA552UA/2K5	Tape and Reel
OPA552PA	DIP-8	006	-40°C to +125°C	OPA552PA	OPA552PA	Rails
OPA552FA	DDPAK-7	328	-40°C to +125°C	OPA552FA	OPA552FA	Rails
"	"	"	"	"	OPA552FA/500	Tape and Reel

NOTES: (1) For detailed drawing and dimension table, please see end of data sheet, or Appendix C of Burr-Brown IC Data Book. (2) Products followed by a slash (/) are only available in Tape and Reel in the quantities indicated (e.g., /2K5 indicates 2500 devices per reel). Ordering 2500 pieces of "OPA551UA/2K5" will get a single 2500-piece Tape and Reel. For detailed Tape and Reel mechanical information, refer to Appendix B of Burr-Brown IC Data Book.

The information provided herein is believed to be reliable; however, BURR-BROWN assumes no responsibility for inaccuracies or omissions. BURR-BROWN assumes no responsibility for the use of this information, and all use of such information shall be entirely at the user's own risk. Prices and specifications are subject to change without notice. No patent rights or licenses to any of the circuits described herein are implied or granted to any third party. BURR-BROWN does not authorize or warrant any BURR-BROWN product for use in life support devices and/or systems.

TYPICAL PERFORMANCE CURVES

At $T_J = +25^\circ\text{C}$, $V_S = \pm 30\text{V}$ and $R_L = 3\text{k}\Omega$, unless otherwise noted.

All temperatures are junction temperatures unless otherwise noted. Refer to the Applications Information section to calculate junction temperatures from ambient temperatures for a specific configuration.

OPEN-LOOP GAIN AND PHASE vs FREQUENCY
OPA551

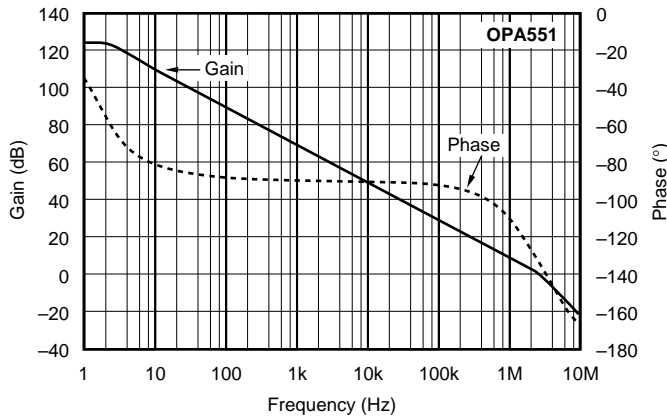

OPEN-LOOP GAIN AND PHASE vs FREQUENCY
OPA552

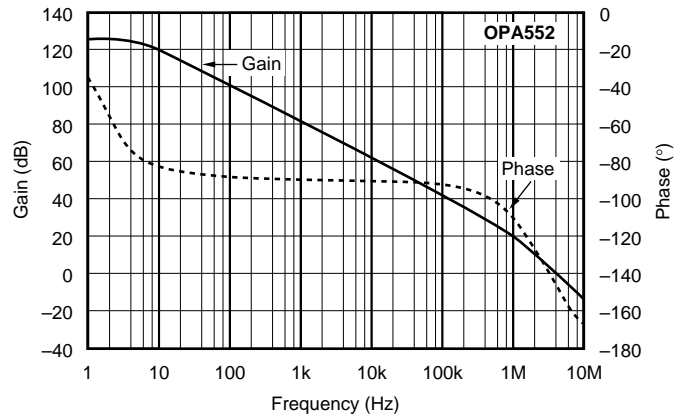

COMMON-MODE REJECTION RATIO vs FREQUENCY

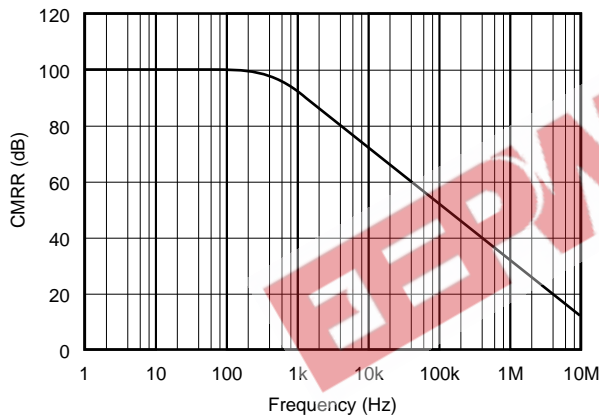

POWER SUPPLY REJECTION RATIO vs FREQUENCY

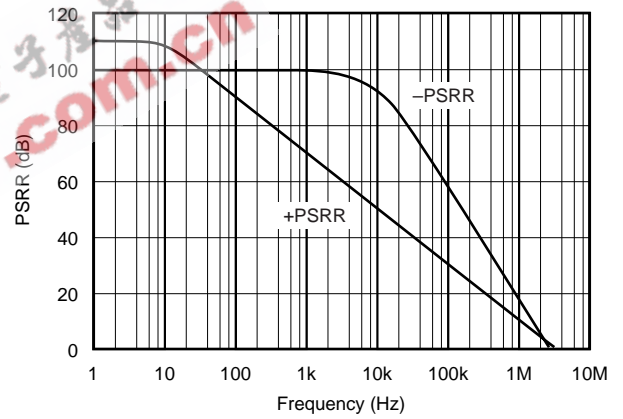

INPUT VOLTAGE AND CURRENT NOISE
SPECTRAL DENSITY vs FREQUENCY

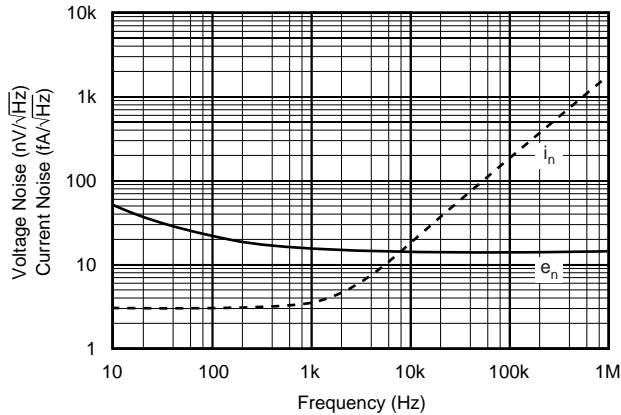

TOTAL HARMONIC DISTORTION + NOISE
vs FREQUENCY

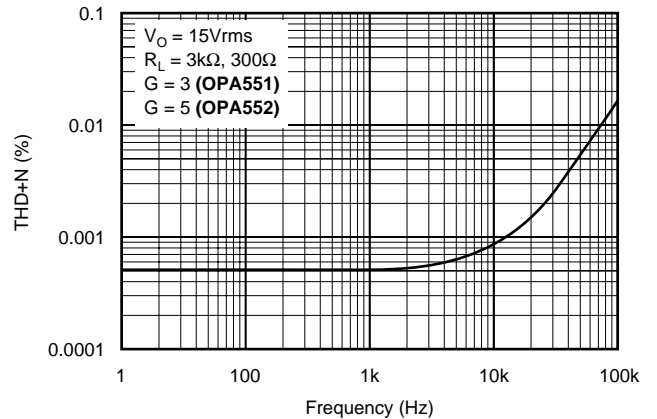

TYPICAL PERFORMANCE CURVES (Cont.)

At $T_J = +25^\circ\text{C}$, $V_S = \pm 30\text{V}$ and $R_L = 3\text{k}\Omega$, unless otherwise noted.

All temperatures are junction temperatures unless otherwise noted. Refer to the Applications Information section to calculate junction temperatures from ambient temperatures for a specific configuration.

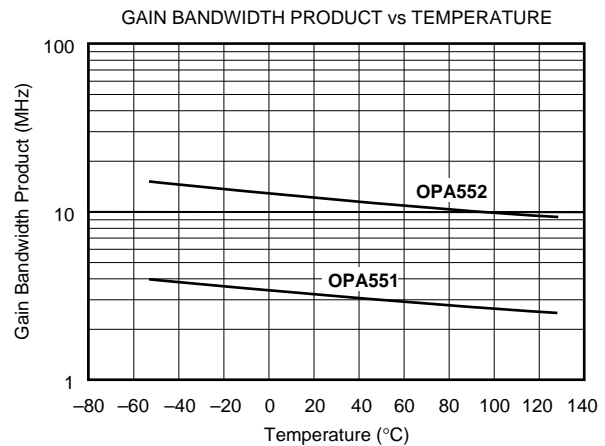
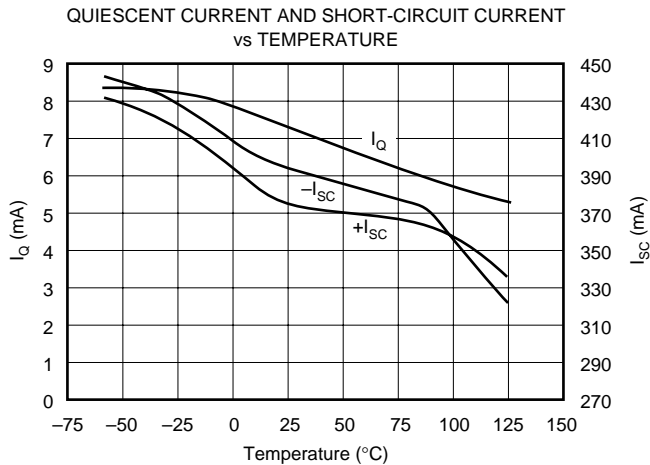
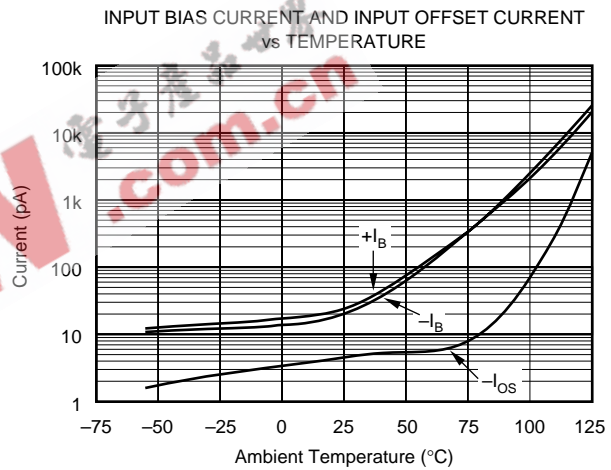
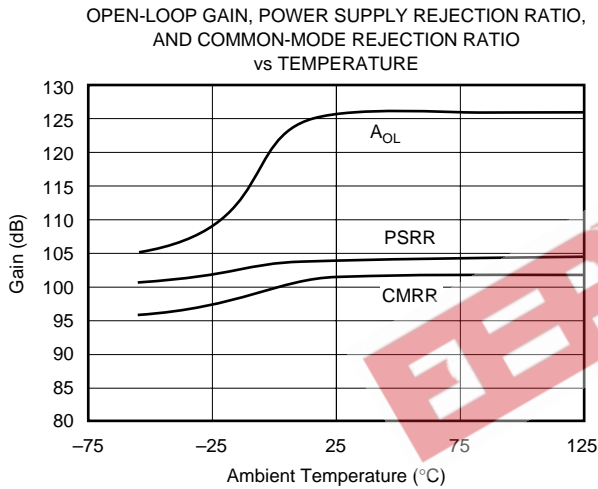
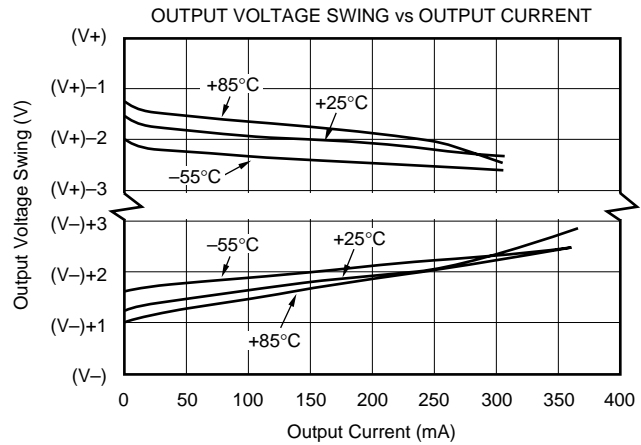
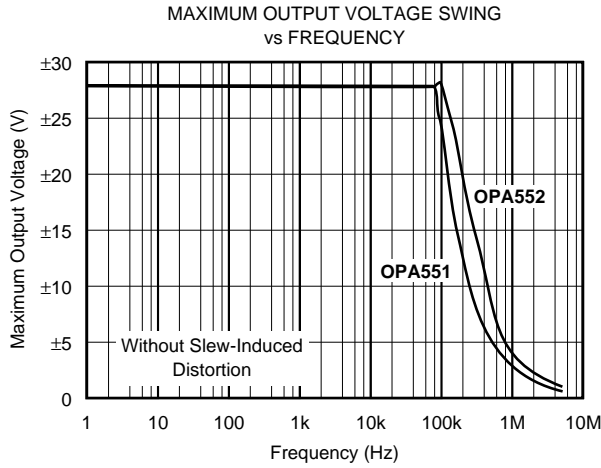

TYPICAL PERFORMANCE CURVES (Cont.)

At $T_J = +25^\circ\text{C}$, $V_S = \pm 30\text{V}$ and $R_L = 3\text{k}\Omega$, unless otherwise noted.

All temperatures are junction temperatures unless otherwise noted. Refer to the Applications Information section to calculate junction temperatures from ambient temperatures for a specific configuration.

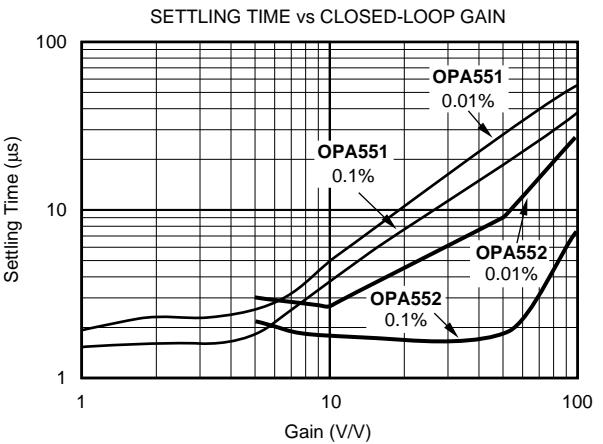
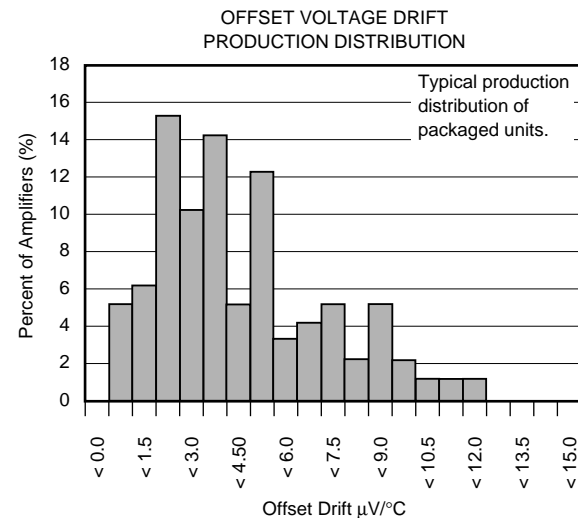
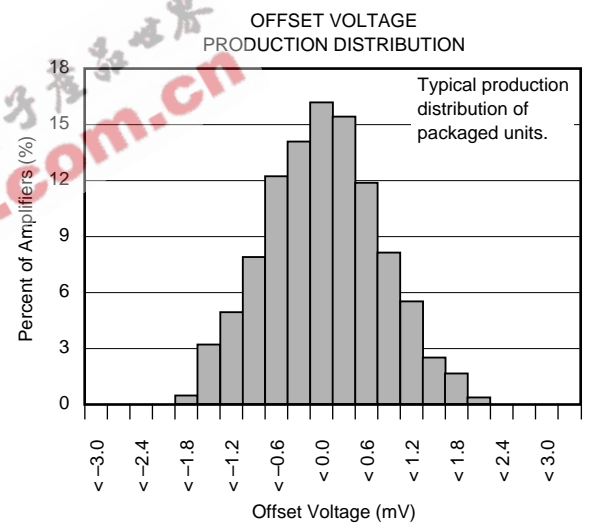
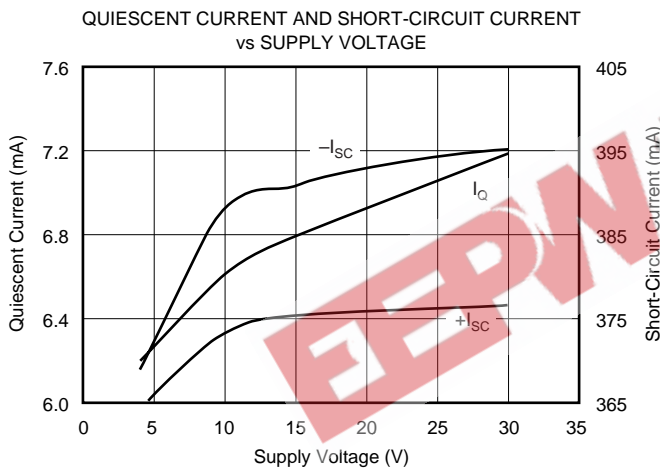
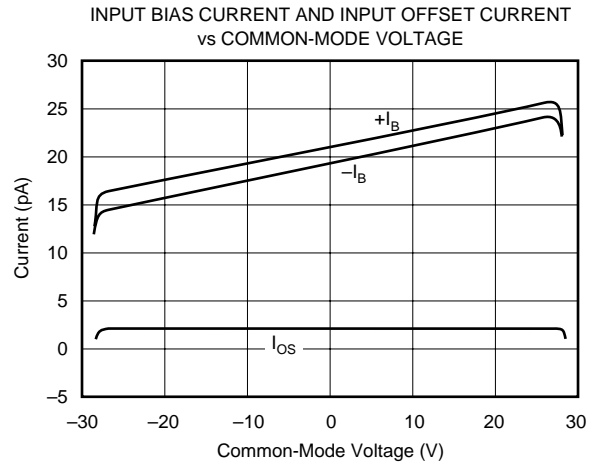
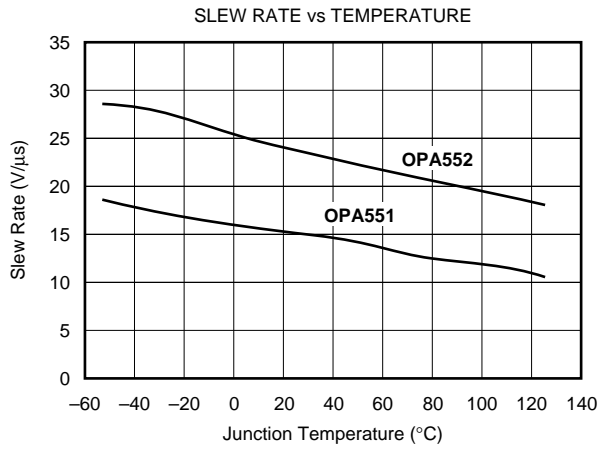

TYPICAL PERFORMANCE CURVES (Cont.)

At $T_J = +25^\circ\text{C}$, $V_S = \pm 30\text{V}$ and $R_L = 3\Omega$, unless otherwise noted.

All temperatures are junction temperatures unless otherwise noted. Refer to the Applications Information section to calculate junction temperatures from ambient temperatures for a specific configuration.

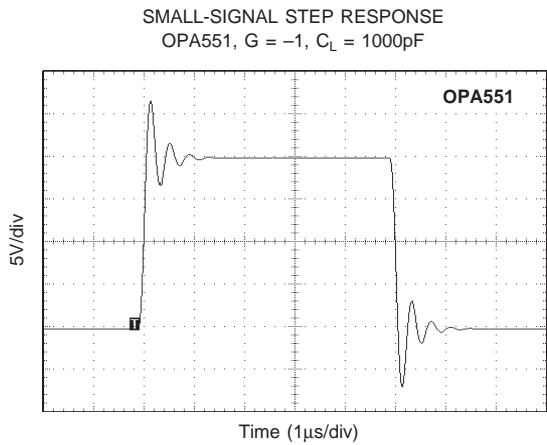
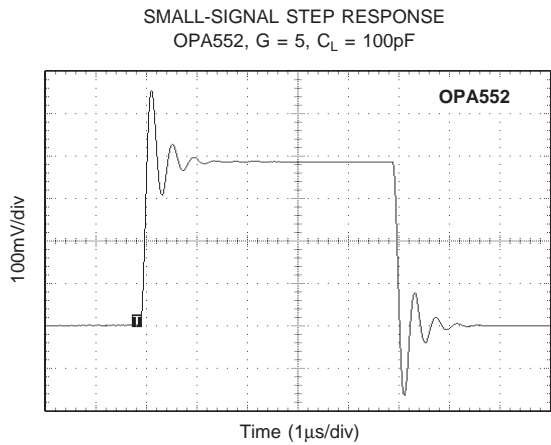
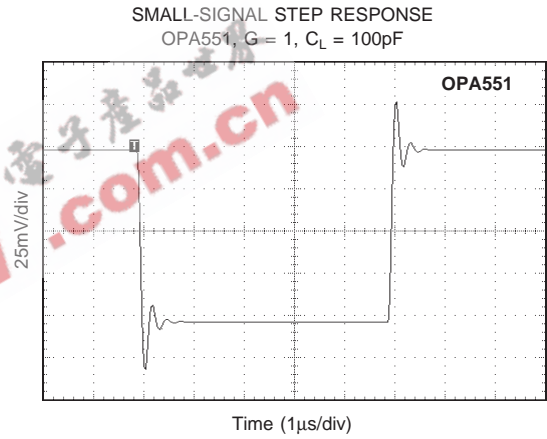
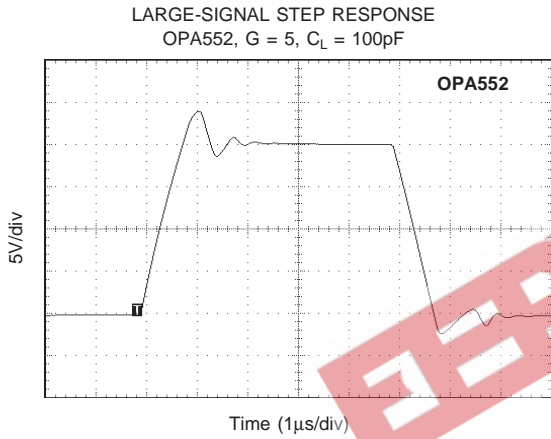
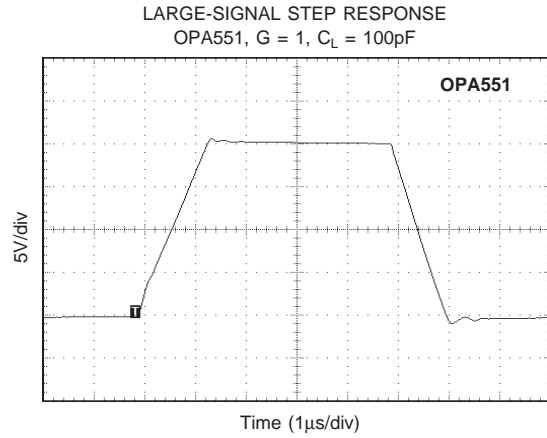
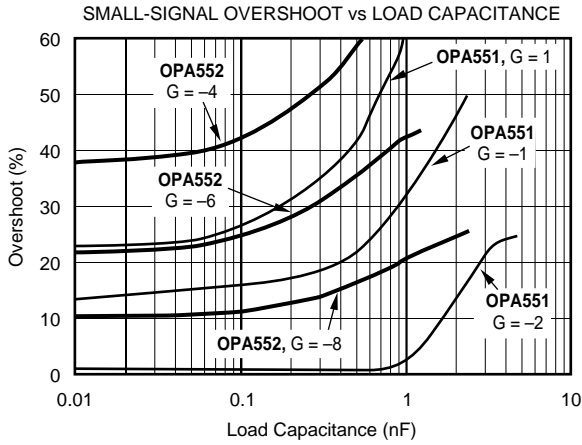

APPLICATIONS INFORMATION

Figure 1 shows the OPA551 connected as a basic non-inverting amplifier. The OPA551 can be used in virtually any op amp configuration. OPA552 is designed for use in configurations with gains of 5 or greater. Power supply terminals should be bypassed with 0.1µF capacitors, or greater, near the power supply pins. Be sure that the capacitors are appropriately rated for the power supply voltage used. The OPA551 and OPA552 can supply output currents up to 200mA with excellent performance.

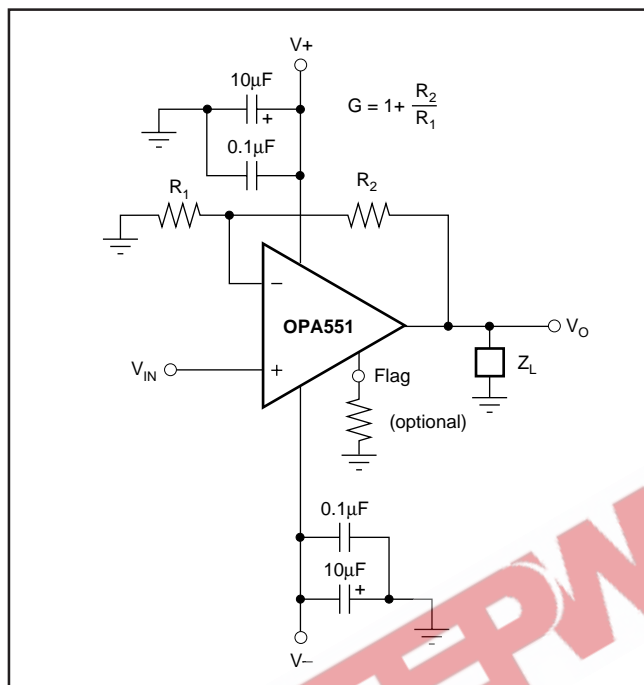

FIGURE 1. Basic Circuit Connections.

CURRENT LIMIT

The OPA551 and OPA552 are designed with internal current-limiting circuitry that limits the output current to approximately 380mA. The current limit varies with increasing junction temperature as shown in the typical curve “Current Limit vs Temperature.” This, in combination with the thermal protection circuitry, provides protection from many types of overload conditions including short circuit to ground.

THERMAL PROTECTION

The OPA551 and OPA552 have thermal shutdown circuitry that protects the amplifier from damage caused by overload conditions. The thermal protection circuitry disables the output when the junction temperature reaches approximately 160°C, allowing the device to cool. When the junction temperature cools to approximately 140°C, the output circuitry is automatically re-enabled.

The thermal shutdown function is not intended to replace proper heat sinking. Activation of the thermal shutdown circuitry is an indication of excessive power dissipation or an inadequate heat sink. Continuously running the amplifier into thermal shutdown can degrade reliability.

The Thermal Shutdown Indicator (“flag”) pin can be monitored to determine if shutdown is occurring. During normal operation, the current output from the flag pin is typically 50nA. During shutdown, the current output from the flag pin increases to 120µA (typical). This current output allows for easy interfacing to external logic. See Figure 2 for two examples implementing this function.

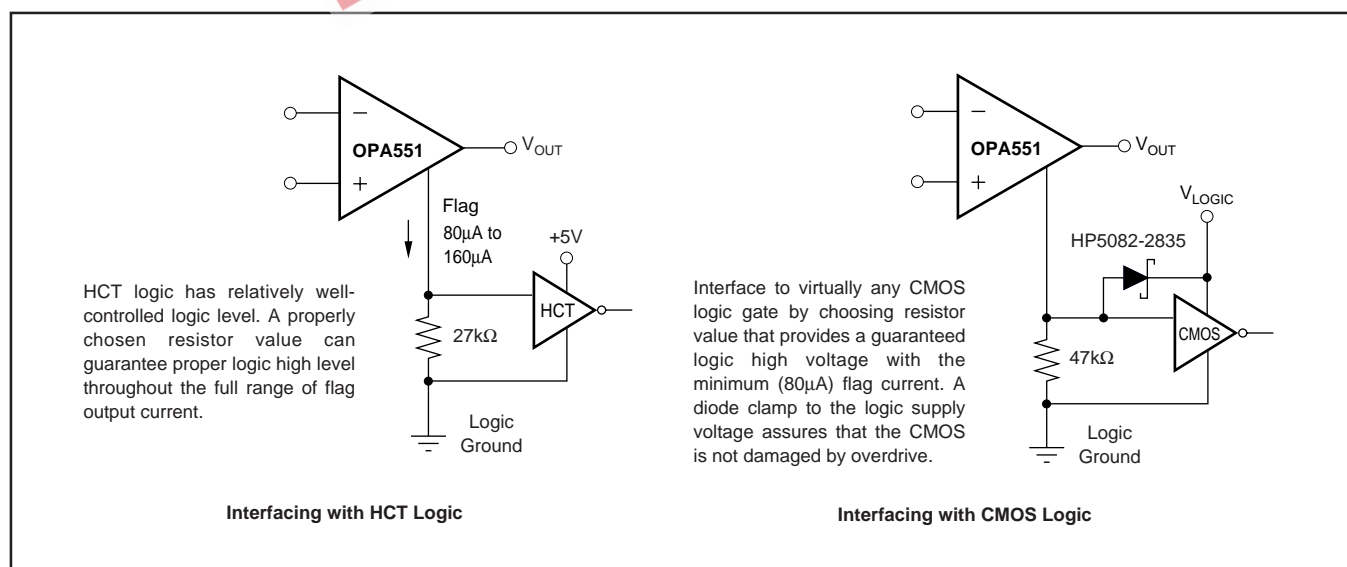

FIGURE 2. Thermal Shutdown Indicator.

POWER SUPPLIES

The OPA551 and OPA552 may be operated from power supplies of $\pm 4\text{V}$ to $\pm 30\text{V}$, or a total of 60V with excellent performance. Most behavior remains unchanged throughout the full operating voltage range. Parameters that vary significantly with operating voltage are shown in the Typical Performance Curves.

For applications that do not require symmetrical output voltage swing, power supply voltages do not need to be equal. The OPA551 and OPA552 can operate with as little as 8V between the supplies or with up to 60V between the supplies. For example, the positive supply could be set to 50V with the negative supply at -10V or vice-versa.

The SO-8 package outline shows three negative supply (V^-) pins. These pins are internally connected for improved thermal performance. **Pin 4 is to be used as the primary current carrier for the negative supply. It is recommended that pins 1 and 5 not be directly connected to V^- but, instead be connected to a thermal mass. DO NOT lay out the PC board to use pins 1 and 5 as feedthroughs to the negative supply. Doing so can result in a reduction of performance.**

The tab of the DDPAK-7 package is electrically connected to the negative supply (V^-), however, this connection should not be used to carry current. For best thermal performance, the tab should be soldered directly to the circuit board copper area (see heat sink text).

POWER DISSIPATION

Internal power dissipation of these op amps can be quite large. Many of the specifications for the OPA551 and OPA552 are for a specified junction temperature. If the device is not subjected to internal self-heating, the junction temperature will be the same as the ambient. However, in practical applications, the device will self-heat and the junction temperature will be significantly higher than ambient. After junction temperature has been established, performance parameters that vary with junction temperature can be determined from the performance curves. The following calculation can be performed to establish junction temperature as a function of ambient temperature and the conditions of the application.

Consider the OPA551 in a circuit configuration where the load is 600Ω and the output voltage is 15V . The supplies are at $\pm 30\text{V}$ and the ambient temperature (T_A) is 40°C . The θ_{JA} for the 8-pin DIP package is $100^\circ\text{C}/\text{W}$.

First, the internal heating of the op amp is as follows:

$$P_{D(\text{internal})} = I_Q \cdot V_S = 7.2\text{mA} \cdot 60\text{V} = 432\text{mW}$$

The output current (I_O) can be calculated:

$$I_O = V_{\text{OUT}}/R_L = 15\text{V}/600\Omega = 25\text{mA}$$

The power being dissipated (P_D) in the output transistor of the amplifier can be calculated:

$$P_{D(\text{output stage})} = I_O \cdot (V_S - V_O) = 25\text{mA} \cdot (30 - 15) = 375\text{mW}$$

$$P_{D(\text{total})} = P_{D(\text{internal})} + P_{D(\text{output stage})} = 432\text{mW} + 375\text{mW} = 807\text{mW}$$

The resulting junction temperature can be calculated:

$$T_J = T_A + P_D \theta_{JA}$$

$$T_J = 40^\circ\text{C} + 807\text{mW} \cdot 100^\circ\text{C}/\text{W} = 120.7^\circ\text{C}$$

Where,

T_J = junction temperature ($^\circ\text{C}$)

T_A = ambient temperature ($^\circ\text{C}$)

θ_{JA} = junction-to-air thermal resistance ($^\circ\text{C}/\text{W}$)

For the DDPAK package, the θ_{JA} is $65^\circ\text{C}/\text{W}$ with no heat sinking, resulting in a junction temperature of 92.5°C .

To estimate the margin of safety in a complete design (including heat sink), increase the ambient temperature until the thermal protection is activated. Use worst-case load and signal conditions. For good reliability, the thermal protection should trigger more than $+35^\circ\text{C}$ above the maximum expected ambient condition of your application. This ensures a maximum junction temperature of $+125^\circ\text{C}$ at the maximum expected ambient condition.

If the OPA551 or OPA552 is to be used in an application requiring more than 0.5W continuous power dissipation, it is recommended that the DDPAK package option be used. The DDPAK has superior thermal dissipation characteristics and is more easily adapted to a heat sink.

Operation from a single power supply (or unbalanced power supplies) can produce even larger power dissipation since a larger voltage can be impressed across the conducting output transistor. Consult Application Bulletin AB-039 for further information on how to calculate or measure power dissipation.

Power dissipation can be minimized by using the lowest possible supply voltage. For example, with a 200mA load, the output will swing to within 3.5V of the power supply rails. Power supplies set to no more than 3.5V above the maximum output voltage swing required by the application will minimize the power dissipation.

SAFE OPERATING AREA

The Safe Operating Area (SOA curves, Figures 3, 4, and 5) shows the permissible range of voltage and current. The curves shown represent devices soldered to a circuit board with no heat sink. The safe output current decreases as the voltage across the output transistor ($V_S - V_O$) increases. For further insight on SOA, consult Application Bulletin AB-039.

Output short circuits are a very demanding case for SOA. A short circuit to ground forces the full power supply voltage ($V+$ or $V-$) across the conducting transistor and produces a typical output current of 380mA . With $\pm 30\text{V}$

power supplies, this creates an internal dissipation of 11.4W. This far exceeds the maximum rating and is not recommended. If operation in this region is unavoidable, use the DDPAK with a heat sink.

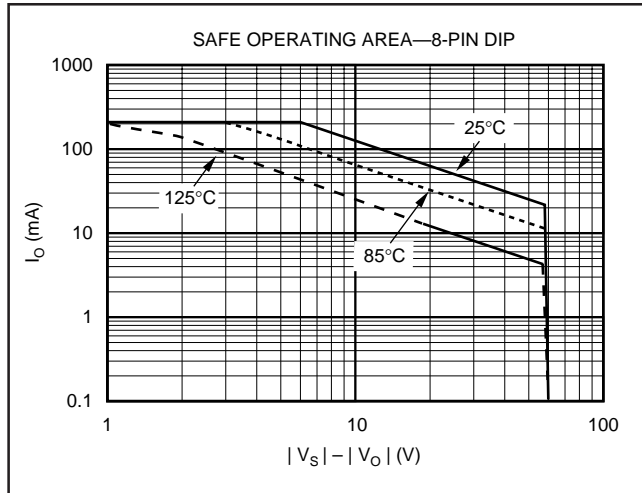

FIGURE 3. DIP-8 Safe Operating Area.

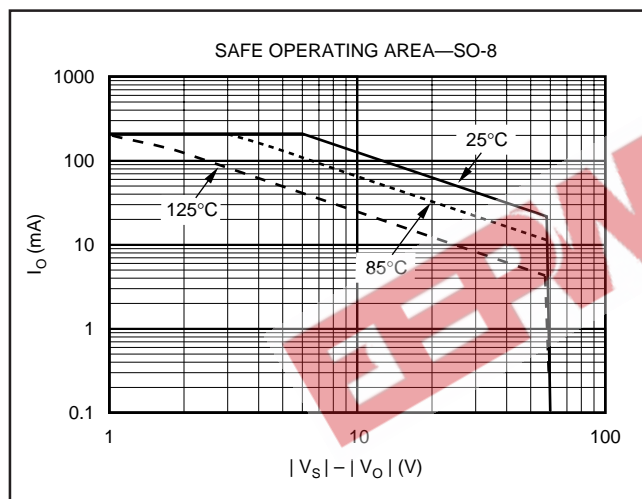

FIGURE 4. SO-8 Safe Operating Area.

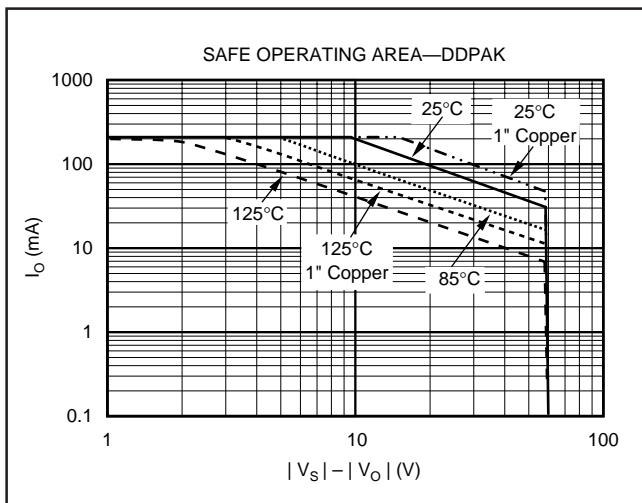

FIGURE 5. DDPAK-7 Safe Operating Area.

HEAT SINKING

Power dissipated in the OPA551 or OPA552 will cause the junction temperature to rise. For reliable operation, the junction temperature should be limited to +125°C. Many applications will require a heat sink to assure that the maximum operating junction temperature is not exceeded. The heat sink required depends on the power dissipated and on ambient conditions.

For heat sinking purposes, the tab of the DDPAK is typically soldered directly to a circuit board copper area. Increasing the copper area improves heat dissipation. Figure 6 shows typical thermal resistance from junction-to-ambient as a function of copper area.

Depending on conditions, additional heat sinking may be required. Aavid Thermal Products Inc. manufactures surface-mountable heat sinks designed specifically for use with DDPAK packages. Further information is available on Aavid's web site, www.aavid.com.

To estimate the margin of safety in a complete design (including heat sink), increase the ambient temperature until the thermal protection is activated. Use worst-case load and signal conditions. For good reliability, the thermal protection should trigger more than +25°C above the maximum expected ambient condition of your application. This produces a junction temperature of +125°C at the maximum expected ambient condition.

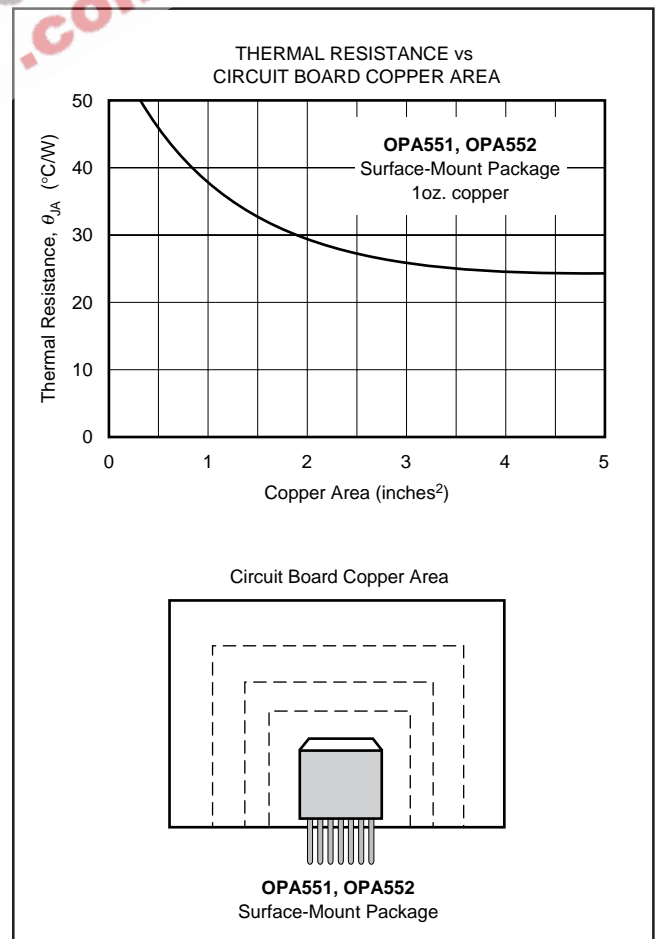

FIGURE 6. DDPAK Thermal Resistance vs Circuit Board Copper Area.

CAPACITIVE LOADS

The dynamic characteristics of the OPA551 and OPA552 have been optimized for commonly encountered gains, loads, and operating conditions. The combination of low closed-loop gain and capacitive load will decrease the phase margin and may lead to gain peaking or oscillations. Figure 7 shows a circuit that preserves phase margin with capacitive load. Figure 8 shows the small-signal step response for the circuit in Figure 7. Consult Application Bulletin AB-028 for more information.

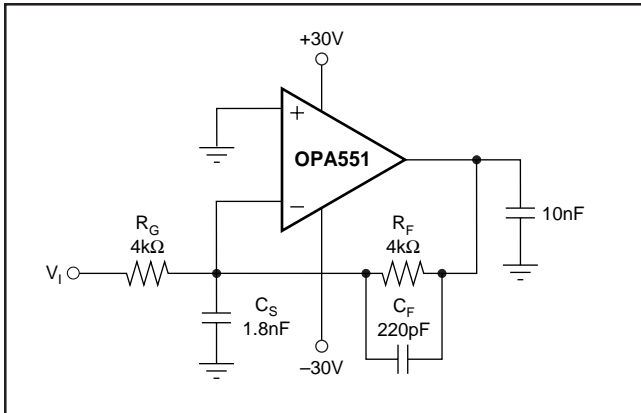

FIGURE 7. Driving Large Capacitive Loads.

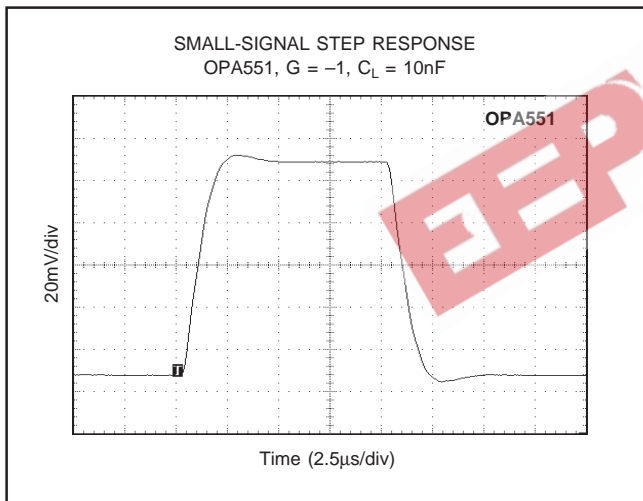

FIGURE 8. Small-Signal Step Response for Figure 7.

INCREASING OUTPUT CURRENT

In those applications where the 200mA of output current is not sufficient to drive the desired load, output current can be increased by connecting two or more OPA551s or OPA552s in parallel as shown in Figure 9. Amplifier A1 is the “master” amplifier and may be configured in virtually an op amp circuit. Amplifier A2, the “slave”, is configured as a unity gain buffer. Alternatively, external output transistors

can be used to boost output current. The circuit in Figure 10 is capable of supplying output currents up to 1A. Alternatively, the OPA547, OPA548, and OPA549 series power op amps should be considered for high output current drive, along with programmable current limit and output disable capability.

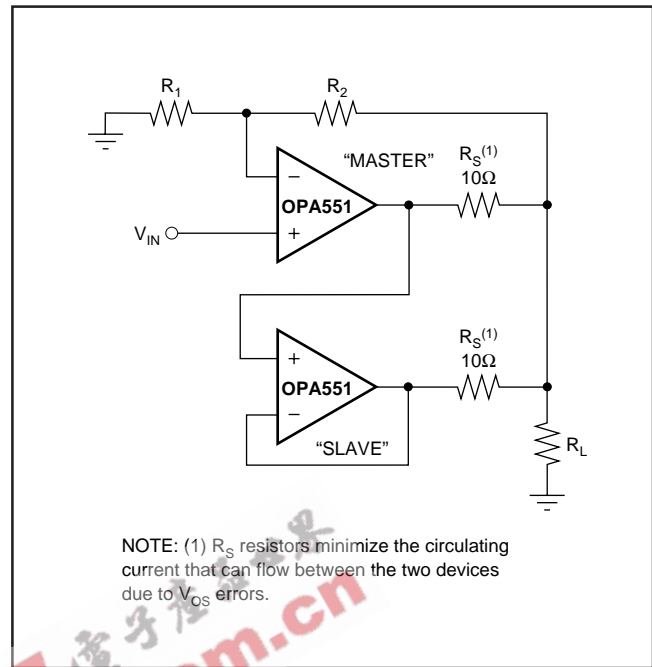

FIGURE 9. Parallel Amplifiers Increase Output Current Capability.

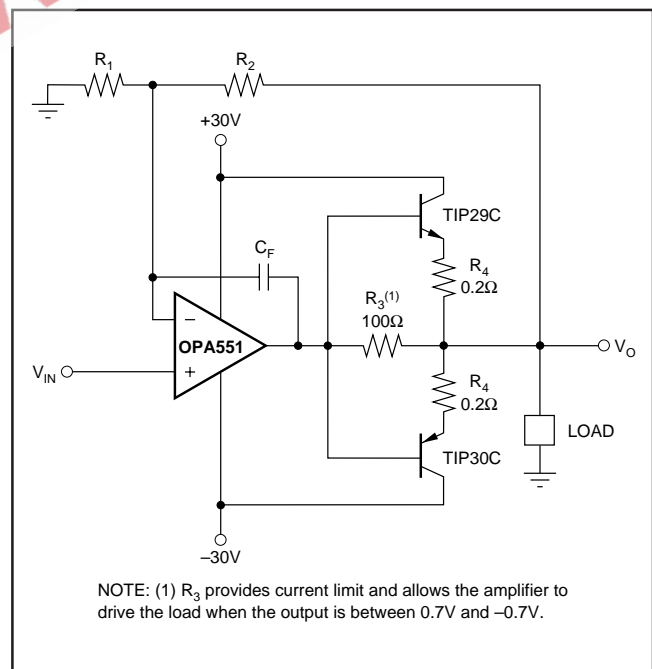

FIGURE 10. External Output Transistors Boost Output Current Up to 1 Amp.

INPUT PROTECTION

The OPA551 and OPA552 feature internal clamp diodes to protect the inputs when voltages beyond the supply rails are encountered. However, input current should be limited to 5mA. In some cases, an external series resistor may be required. Many input signals are inherently current-limited, therefore, a limiting resistor may not be required. Please consider that a “large” series resistor, in conjunction with the input capacitance, can affect stability.

USING THE OPA552 IN LOW GAINS

The OPA552 family is intended for applications with signal gains of 5 or greater, but it is possible to take advantage of their high slew rate in lower gains using an external compensation technique in an inverting configuration. This technique maintains low noise characteristics of the OPA552 architecture at low frequencies. Depending on the application, a small increase in high frequency noise may result. This technique shapes the loop gain for good stability while giving an easily controlled second-order low-pass frequency response.

Considering only the noise gain (non-inverting signal gain) for the circuit of Figure 11, the low frequency noise gain (NG_1) will be set by the resistor ratios, while the high frequency noise gain (NG_2) will be set by the capacitor ratios. The capacitor values set both the transition frequencies and the high frequency noise gain. If this noise gain, determined by $NG_2 = 1 + C_S/C_F$, is set to a value greater than the recommended minimum stable gain for the op amp and the noise gain pole, set by $1/R_F C_F$, is placed correctly, a very well controlled, 2nd-order low-pass frequency response will result.

To choose the values for both C_S and C_F , two parameters and only three equations need to be solved. First, the target for the high frequency noise gain (NG_2) should be greater than the minimum stable gain for the OPA552. In the circuit in Figure 11, a target NG_2 of 10 is used. Second, the signal gain of -1 shown in Figure 11 sets the low frequency noise gain to $NG_1 = 1 + R_F/R_G (=2$ in this example). Using these two gains, knowing the Gain Bandwidth Product (GBP) for the OPA552 (12MHz), and targeting a maximally flat 2nd-order, low-pass Butterworth frequency response ($Q = 0.707$), the key frequency in the compensation can be found.

For the values shown in Figure 11, the f_{-3dB} will be approximately 956kHz. This is less than that predicted by simply dividing the GBP by NG_1 . The compensation network controls the bandwidth to a lower value while

providing the full slew rate at the output and an exceptional distortion performance due to increased loop gain at frequencies below $NG_1 \cdot Z_0$. The capacitor values shown in Figure 11 are calculated for $NG_1 = 2$ and $NG_2 = 10$ with no adjustment for parasitics.

Actual circuit values can be optimized by check the small-signal step response with actual load conditions. Figure 12 shows the small-signal step response of this OPA552, $G = -1$ circuit with a 500pF load. It is well-behaved with no tendency to oscillate. If C_S and C_F were removed, the circuit would be unstable.

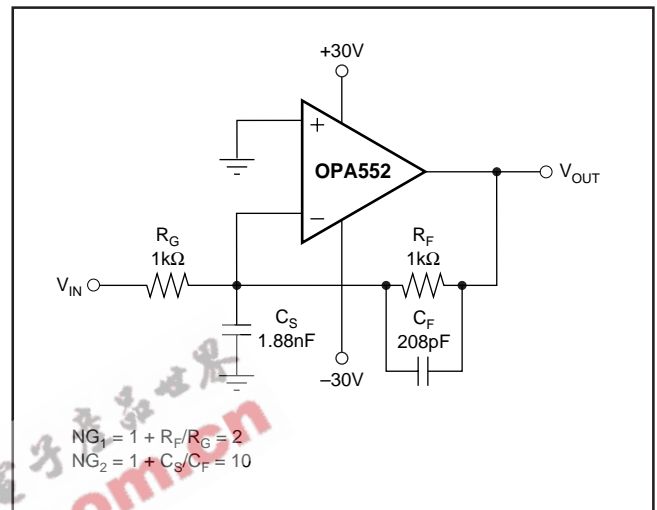

FIGURE 11. Compensation of the OPA552 for $G = 1$.

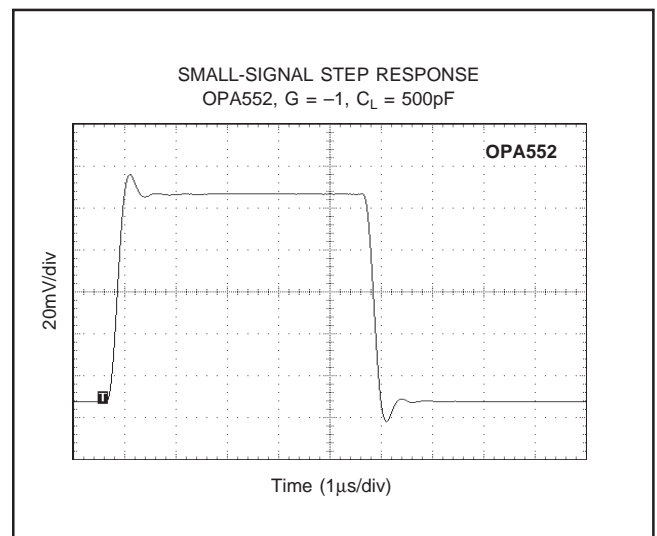

FIGURE 12. Small-Signal Step Response for Figure 11.

OFFSET VOLTAGE ERROR CALCULATION

The offset voltage (V_{OS}) of the OPA51 and OPA552 is specified with a $\pm 30V$ power supply and the common-mode voltage centered between the supplies ($V_S/2 = 0V$). Additional specifications for power supply rejection and common-mode rejection are provided to allow the user to easily calculate worst-case expected offset under the conditions of a given application.

Power Supply Rejection Ratio (PSRR) is specified in $\mu V/V$. For the OPA551 and OPA552, worst-case PSRR is $30\mu V/V$, which means for each volt of change in total power supply voltage, the offset may shift by up to $30\mu V/V$. Common-Mode Rejection Ratio (CMRR) is specified in dB, which can be converted to $\mu V/V$ using the following equation:

$$\text{CMRR in (V/V)} = 10^{[(\text{CMRR in dB})/-20]} \quad (1)$$

For the OPA551 and OPA552, the worst-case CMRR at $\pm 30mV$ supply over the full common-mode range is 96dB, or approximately $15.8\mu V/V$. This means that for every volt of change in common-mode, the offset may shift up to $15.8\mu V$. These numbers can be used to

calculate excursions from the specified offset voltage under different applications conditions. For example, a common application might configure the amplifier with a -48 single supply with $-6V$ common-mode. This configuration represents a 12V variation in power supply: $\pm 30V$ or 60V in the offset specification versus 48V in the application. In addition, this configuration has an 18V variation in common-mode voltage: $V_S/2 = -24V$ is the specification for these power supplies, but the common-mode voltage is $-6V$ in the application.

Calculation of the worst-case expected offset would be as follows:

$$\begin{aligned} \text{Worst-case } V_{OS} = & \quad (2) \\ & \text{maximum specified } V_{OS} \\ & + (\text{power supply variation} \cdot \text{PSRR}) \\ & + (\text{common-mode variation} \cdot \text{CMRR}) \end{aligned}$$

$$\begin{aligned} V_{OSwc} &= 5mV + (12V \cdot 30\mu V/V) + (18V \cdot 15.8\mu V/V) \\ &= \pm 5.64mV \end{aligned}$$

EEPW 电子产品世界
.com.cn