



SINGLE-SUPPLY, RAIL-TO-RAIL OPERATIONAL AMPLIFIER WITH SHUTDOWN

microAmplifier™ Series

FEATURES

- RAIL-TO-RAIL INPUT AND OUTPUT SWING
- *MicroSIZE* PACKAGES
- BANDWIDTH: 5.5MHz
- SLEW RATE: 6V/μs
- QUIESCENT CURRENT: 750μA/Chan
- POWER SHUTDOWN MODE

APPLICATIONS

- SENSOR BIASING
- SIGNAL CONDITIONING
- DATA ACQUISITION
- PROCESS CONTROL
- ACTIVE FILTERS
- TEST EQUIPMENT

DESCRIPTION

The OPA341 series rail-to-rail CMOS operational amplifiers are designed for low-cost, miniature applications. They are optimized for low-voltage, single-supply operation. Rail-to-rail input and output and high-speed operation make them ideal for driving sampling Analog-to-Digital (A/D) converters.

The power-saving shutdown feature makes the OPA341 ideal for portable low-power applications. The OPA341 series is also well suited for general-purpose and audio applications as well as providing I/V conversion at the output of Digital-to-Analog (D/A) converters. Single and dual versions have identical specifications for design flexibility.

The OPA341 series operate on a single supply as low as 2.5V, and input common-mode voltage range extends 300mV beyond the supply rails. Output voltage swings to within 1mV of the supply rails with a 100kΩ load. The OPA341 series offers excellent dynamic response (BW = 5.5MHz, SR = 6V/μs) with a quiescent current of only 750μA. The dual design features completely independent circuitry for lowest crosstalk and freedom from interaction.

The single (OPA341) packages are the tiny SOT23-6 surface mount and SO-8 surface mount. The dual (OPA2341) comes in the miniature MSOP-10 surface mount. All are specified from -55°C to +125°C and operate from -55°C to +150°C. The OPA343 provides similar performance without shutdown capability.

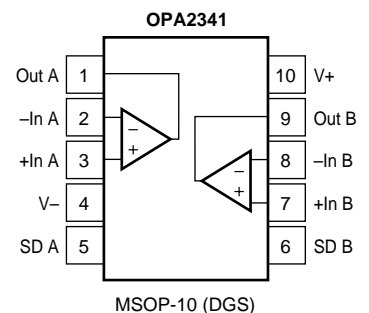
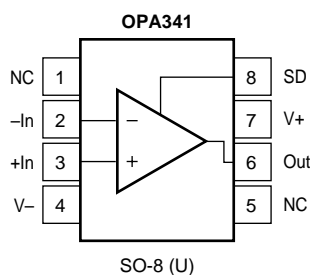
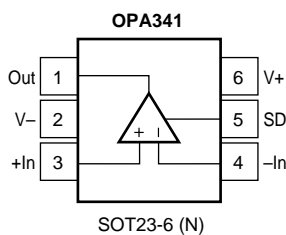

Please be aware that an important notice concerning availability, standard warranty, and use in critical applications of Texas Instruments semiconductor products and disclaimers thereto appears at the end of this data sheet.

ABSOLUTE MAXIMUM RATINGS⁽¹⁾

Supply Voltage, V+ to V-	6.0V
Input Voltage Range ⁽²⁾	(V-) - 0.5V to (V+) + 0.5V
Input Terminal ⁽³⁾	10mA
Output Short Circuit ⁽³⁾	Continuous
Operating Temperature	-55°C to +150°C
Storage Temperature	-65°C to +150°C
Junction Temperature	150°C
Lead Temperature (soldering, 10s)	300°C

NOTES: (1) Stresses above these ratings may cause permanent damage. Exposure to absolute maximum conditions for extended periods may degrade device reliability. (2) Input terminals are diode-clamped to the power supply rails. Input signals that can swing more than 0.5V beyond the supply rails should be current-limited to 10mA or less. (3) Short-circuit to ground, one amplifier per package.



ELECTROSTATIC DISCHARGE SENSITIVITY

This integrated circuit can be damaged by ESD. Texas Instruments recommends that all integrated circuits be handled with appropriate precautions. Failure to observe proper handling and installation procedures can cause damage.

ESD damage can range from subtle performance degradation to complete device failure. Precision integrated circuits may be more susceptible to damage because very small parametric changes could cause the device not to meet its published specifications.

PACKAGE/ORDERING INFORMATION

PRODUCT	PACKAGE	PACKAGE DRAWING NUMBER	PACKAGE DESIGNATOR	SPECIFIED TEMPERATURE RANGE	PACKAGE MARKING	ORDERING NUMBER ⁽¹⁾	TRANSPORT MEDIA
OPA341NA	SOT23-6	332	—	-55°C to +125°C	B41	OPA341NA/250	Tape and Reel
"	"	"	—	"	"	OPA341NA/3K	Tape and Reel
OPA341UA	SO-8	182	—	-55°C to +125°C	OPA341UA	OPA341UA	Rails
"	"	"	—	"	"	OPA341UA/2K5	Tape and Reel
OPA2341DGSA	MSOP-10	4073272	DGS	-55°C to +125°C	C41	OPA2341DGSA/250	Tape and Reel
"	"	"	"	"	"	OPA2341DGSA/2K5	Tape and Reel

NOTE: (1) Models with a slash (/) are available only in Tape and Reel in the quantities indicated (e.g., /3K indicates 3000 devices per reel). Ordering 3000 pieces of "OPA341NA/3K" will get a single 3000-piece Tape and Reel.

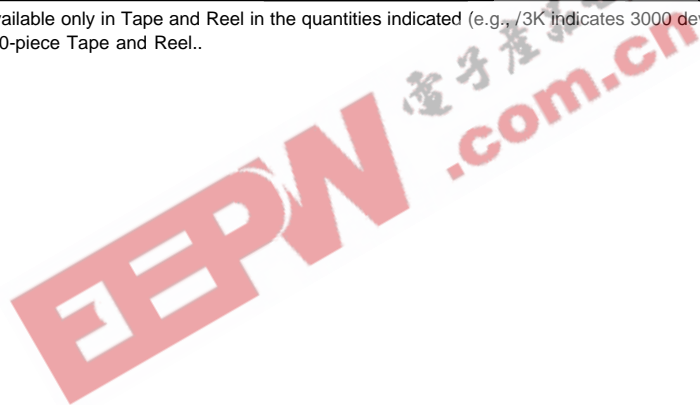

ELECTRICAL CHARACTERISTICS: $V_S = 2.7V$ to $5.5V$

Boldface limits apply over the specified temperature range, $T_A = -55^\circ\text{C}$ to $+125^\circ\text{C}$.

At $T_A = +25^\circ\text{C}$, $R_L = 10\text{k}\Omega$ connected to $V_S/2$ and $V_{OUT} = V_S/2$, $V_{ENABLE} = V_{DD}$, unless otherwise noted.

PARAMETER	CONDITION	OPA341NA, UA OPA2341DGSA			UNITS
		MIN	TYP	MAX	
OFFSET VOLTAGE Input Offset Voltage Drift vs Power Supply Over Temperature Channel Separation, dc	V_{OS} dV_{OS}/dT PSRR $V_S = 5V$ $V_S = 2.7V$ to $5.5V$, $V_{CM} = 0V$ $V_S = 2.7V$ to $5.5V$, $V_{CM} = 0V$		± 2 ± 2 40 0.2	± 6 200 200	mV $\mu\text{V}/^\circ\text{C}$ $\mu\text{V}/\text{V}$ $\mu\text{V}/\text{V}$
INPUT BIAS CURRENT Input Bias Current Over Temperature Input Offset Current	I_B I_{OS}		± 0.6 ± 0.2	± 10 2000 ± 10	pA pA pA
NOISE Input Voltage Noise, $f = 0.1\text{Hz}$ to 50kHz Input Voltage Noise Density, $f = 1\text{kHz}$ Input Current Noise Density, $f = 1\text{kHz}$	e_n i_n		8 25 3		μVrms $\text{nV}/\sqrt{\text{Hz}}$ $\text{fA}/\sqrt{\text{Hz}}$
INPUT VOLTAGE RANGE Common-Mode Voltage Range Common-Mode Rejection Ratio Over Temperature Over Temperature Over Temperature	V_{CM} CMRR $V_S = 5V$, $(V-) - 0.3V < V_{CM} < (V+) - 1.8V$ $V_S = 5V$, $(V-) - 0.1V < V_{CM} < (V+) - 1.8V$ $V_S = 5V$, $(V-) - 0.3V < V_{CM} < (V+) + 0.3V$ $V_S = 5V$, $(V-) - 0.1V < V_{CM} < (V+) + 0.1V$ $V_S = 2.7V$, $(V-) - 0.3V < V_{CM} < (V+) + 0.3V$ $V_S = 2.7V$, $(V-) - 0.1V < V_{CM} < (V+) + 0.1V$	$(V-) - 0.3$ $(V-) - 0.1$ 76 74 60 58 57 55	90 74 70	$(V+) + 0.3$ $(V+) + 0.1$	V V dB dB dB dB dB
INPUT IMPEDANCE Differential Common-Mode			$10^{13} \parallel 3$ $10^{13} \parallel 6$		$\Omega \parallel \text{pF}$ $\Omega \parallel \text{pF}$
OPEN-LOOP GAIN Open-Loop Voltage Gain Over Temperature Over Temperature	A_{OL} $R_L = 100\text{k}\Omega$, $(V-) + 5\text{mV} < V_O < (V+) - 5\text{mV}$ $R_L = 100\text{k}\Omega$, $(V-) + 5\text{mV} < V_O < (V+) - 5\text{mV}$ $R_L = 2\text{k}\Omega$, $(V-) + 200\text{mV} < V_O < (V+) - 200\text{mV}$ $R_L = 2\text{k}\Omega$, $(V-) + 200\text{mV} < V_O < (V+) - 200\text{mV}$	100 100 96 94	120 110		dB dB dB dB
FREQUENCY RESPONSE Gain-Bandwidth Product Slew Rate Settling Time, 0.1% 0.01% Overload Recovery Time Total Harmonic Distortion + Noise	GBW SR t_S $V_{IN} \cdot \text{Gain} \leq V_S$ THD+N $V_S = 5V$		5.5 6 1 1.6 0.2 0.0007		MHz V/ μs μs μs μs %
OUTPUT Voltage Output Swing from Rail Over Temperature Over Temperature Short-Circuit Current Capacitive Load Drive	I_{SC} C_{LOAD} $R_L = 100\text{k}\Omega$, $A_{OL} > 100\text{dB}$ $R_L = 100\text{k}\Omega$, $A_{OL} > 100\text{dB}$ $R_L = 2\text{k}\Omega$, $A_{OL} > 96\text{dB}$ $R_L = 2\text{k}\Omega$, $A_{OL} > 94\text{dB}$		1 40 ± 50	5 5 200 200	mV mV mV mV mA
SHUTDOWN t_{OFF} t_{ON} V_L (Shutdown) V_H (Amplifier is Active) I_{QSD}			$V-$ $(V-) + 2$ 10	1 3 $(V-) + 0.8$ $V+$	μs μs V V nA
POWER SUPPLY Specified Voltage Range Operating Voltage Range Quiescent Current (per amplifier) Over Temperature	V_S I_Q $I_O = 0$, $V_S = 5V$	2.7	2.5 to 5.5 0.75	5.5 1.0 1.2	V V mA mA
TEMPERATURE RANGE Specified Range Operating Range Storage Range Thermal Resistance SOT-23-6 Surface Mount MSOP-10 Surface Mount SO-8 Surface Mount	θ_{JA}	-55 -55 -65		125 150 150	$^\circ\text{C}$ $^\circ\text{C}$ $^\circ\text{C}$ $^\circ\text{C}/\text{W}$ $^\circ\text{C}/\text{W}$ $^\circ\text{C}/\text{W}$ $^\circ\text{C}/\text{W}$

NOTE: (1) $V_{OUT} = 0.25V$ to $3.25V$.

TYPICAL CHARACTERISTICS

At $T_A = +25^\circ\text{C}$, $V_{\text{ENABLE}} = V_{\text{DD}}$, $V_S = +5\text{V}$, $R_L = 10\text{k}\Omega$, unless otherwise noted.

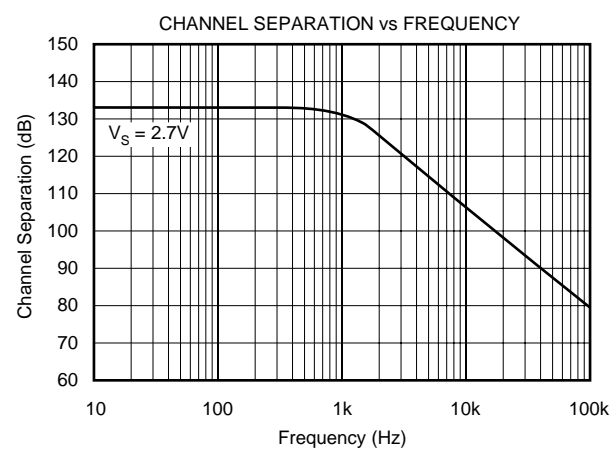
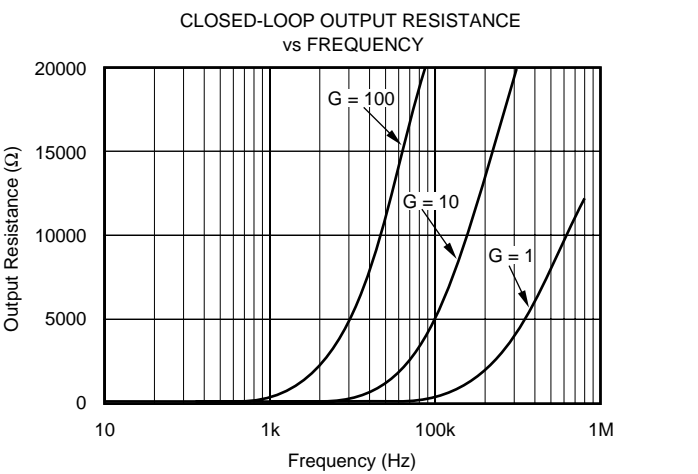
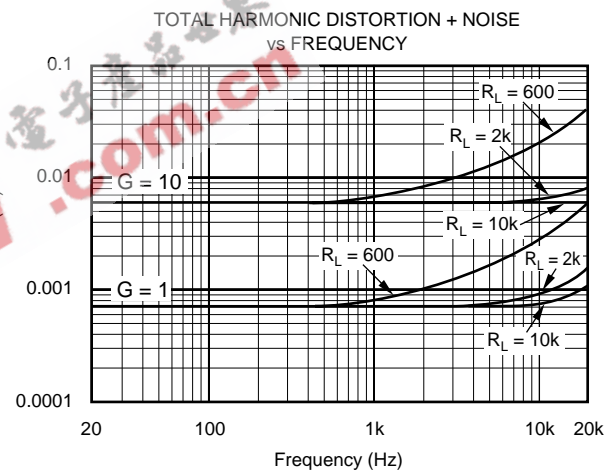
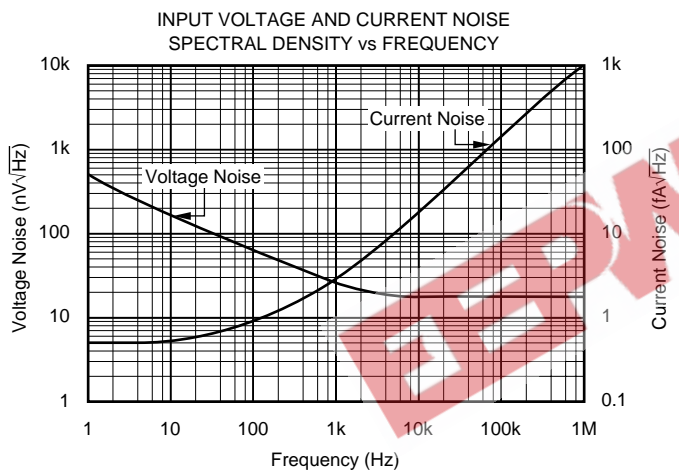
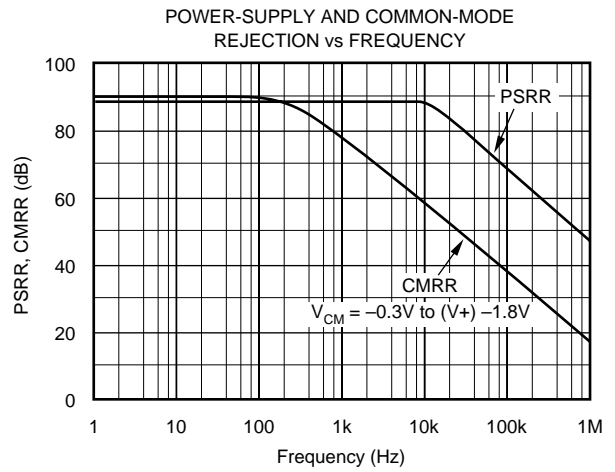
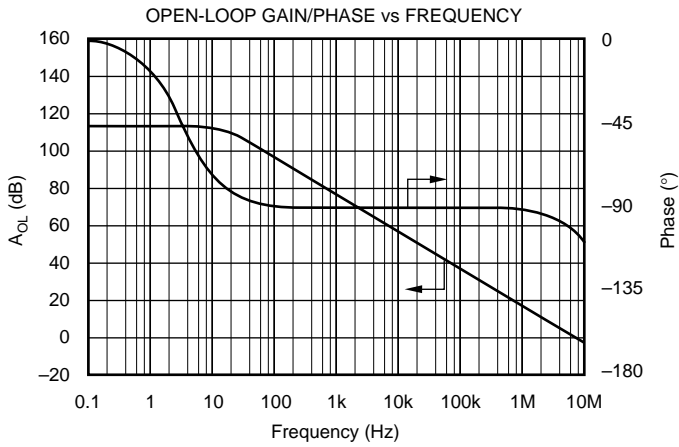

TYPICAL CHARACTERISTICS (Cont.)

At $T_A = +25^\circ\text{C}$, $V_{\text{ENABLE}} = V_{\text{DD}}$, $V_S = +5\text{V}$, $R_L = 10\text{k}\Omega$, unless otherwise noted.

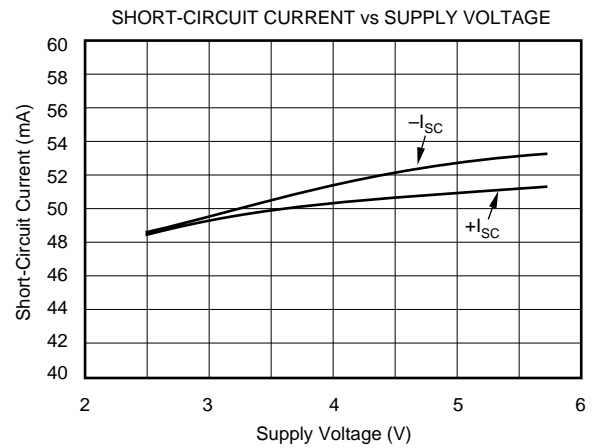
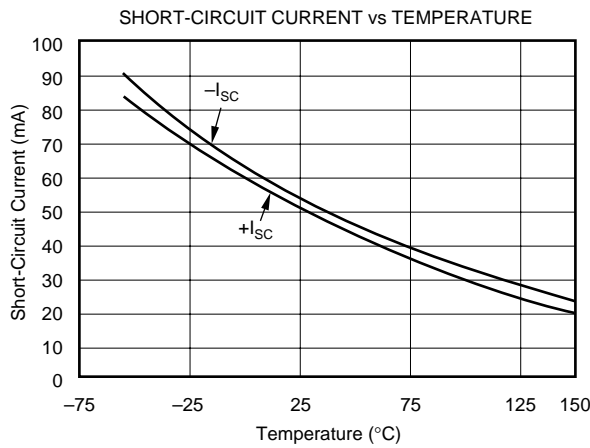
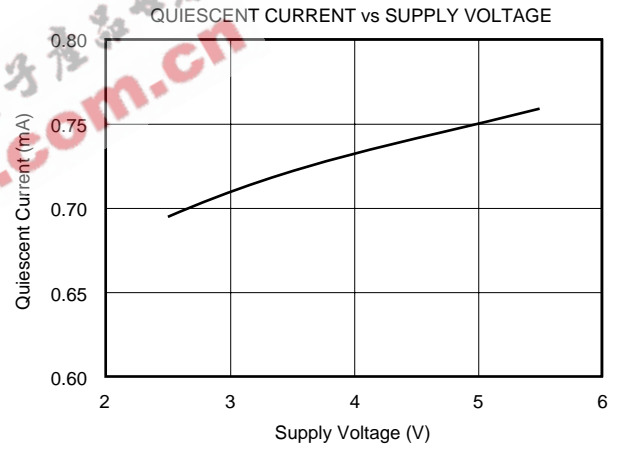
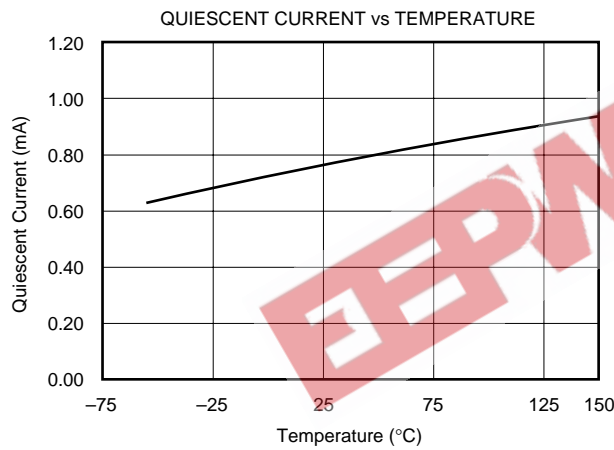
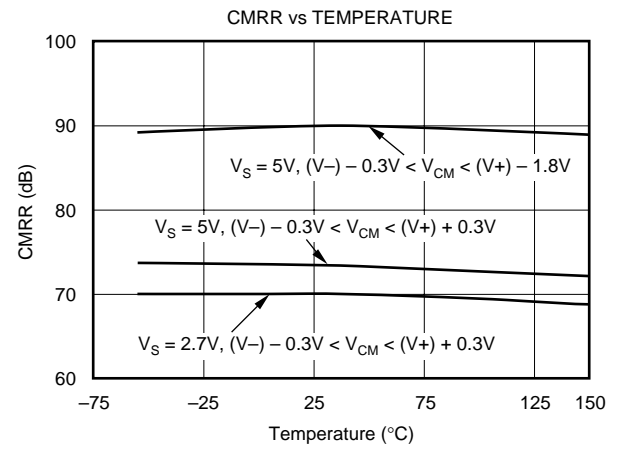
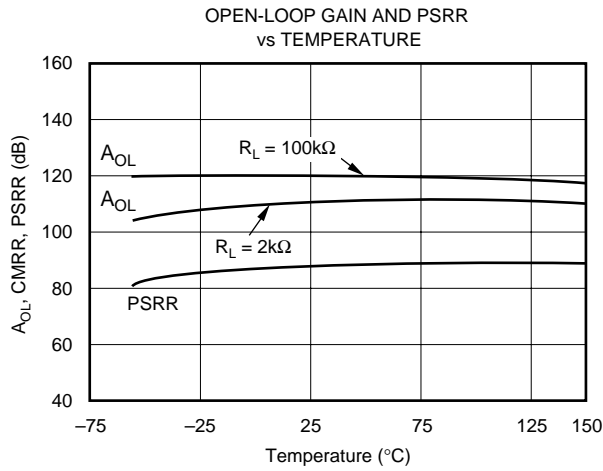

TYPICAL CHARACTERISTICS (Cont.)

At $T_A = +25^\circ\text{C}$, $V_{\text{ENABLE}} = V_{\text{DD}}$, $V_S = +5\text{V}$, $R_L = 10\text{k}\Omega$, unless otherwise noted.

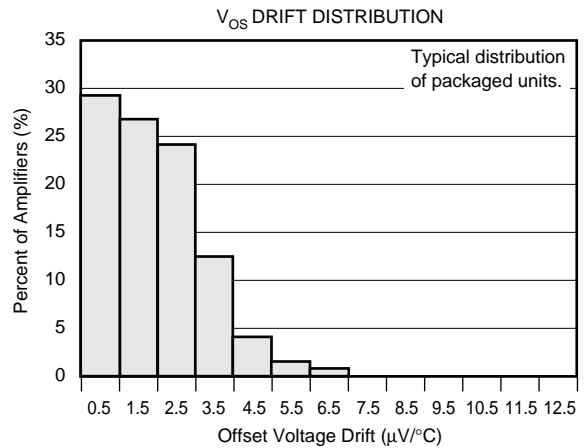
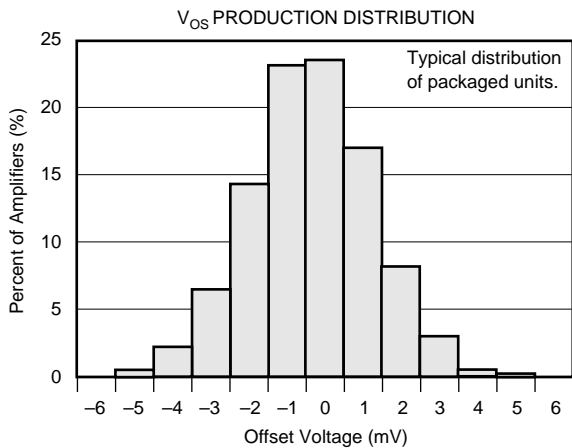
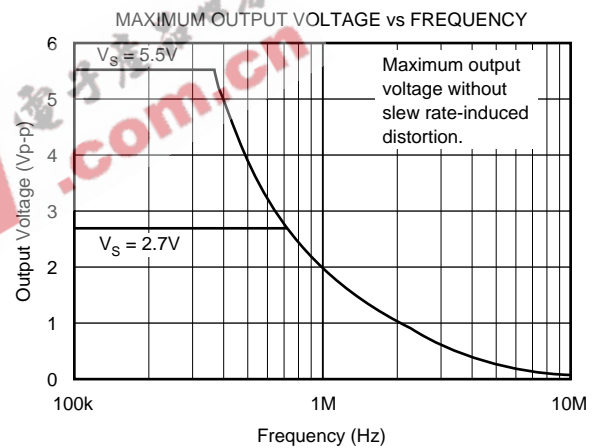
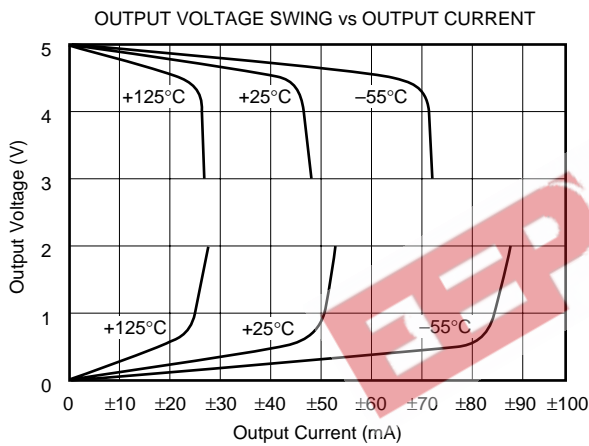
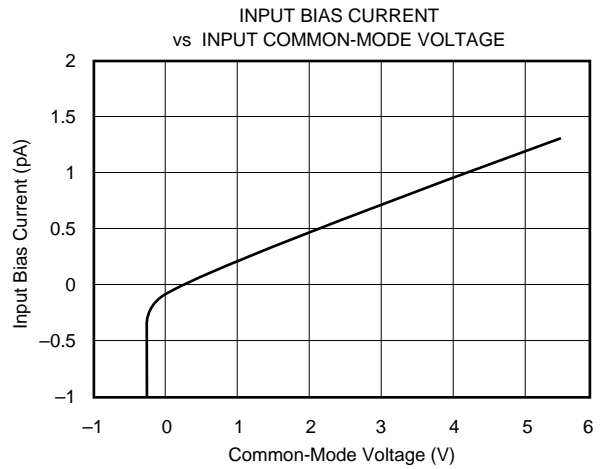
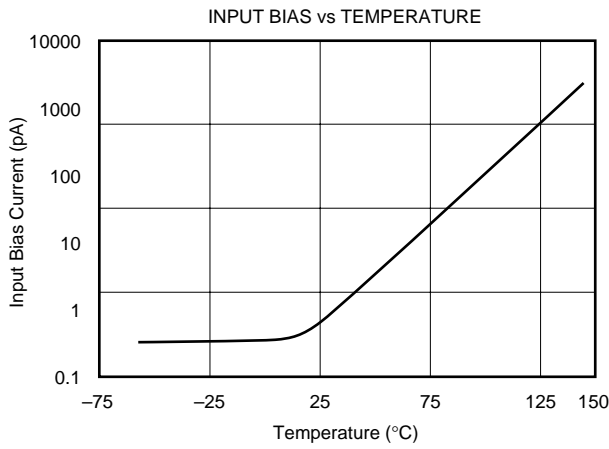

TYPICAL CHARACTERISTICS (Cont.)

At $T_A = +25^\circ\text{C}$, $V_{\text{ENABLE}} = V_{\text{DD}}$, $V_S = +5\text{V}$, $R_L = 10\text{k}\Omega$, unless otherwise noted.

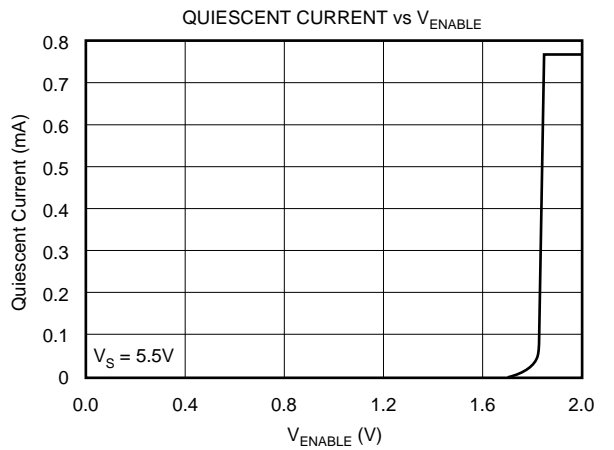
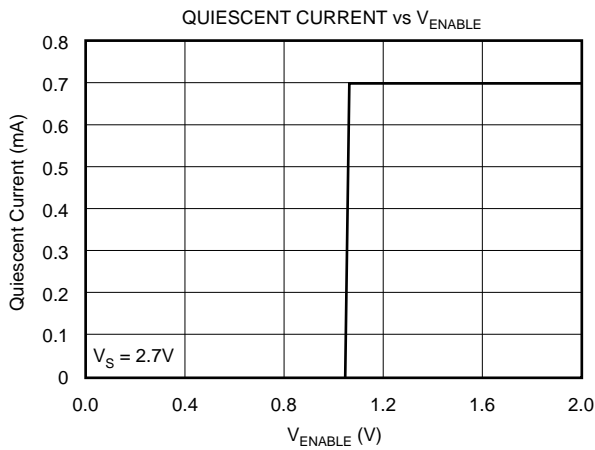
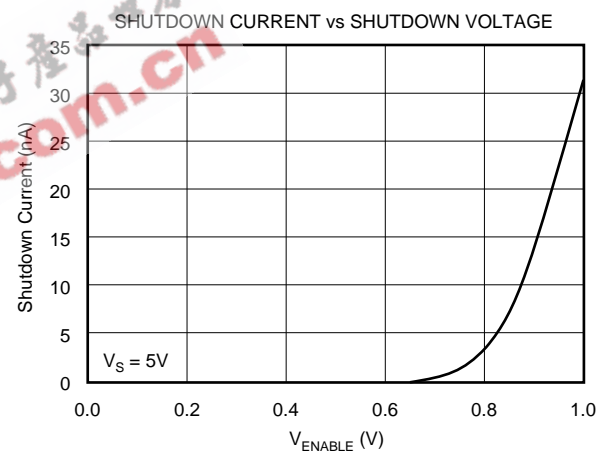
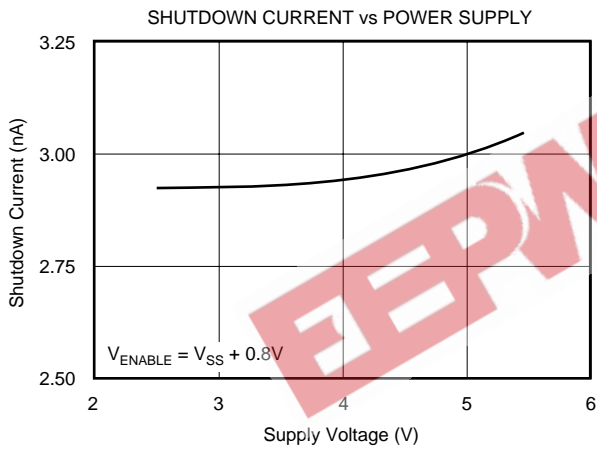
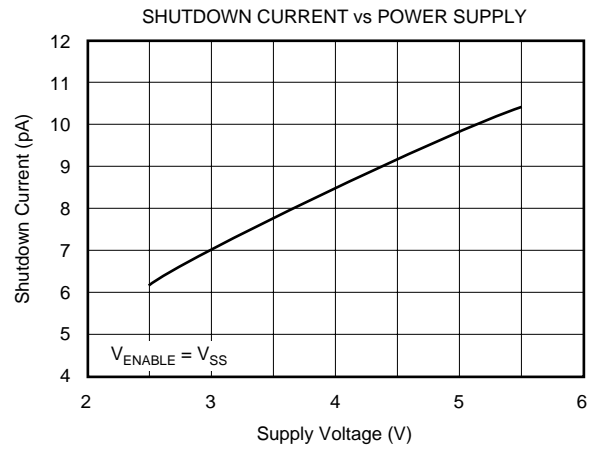
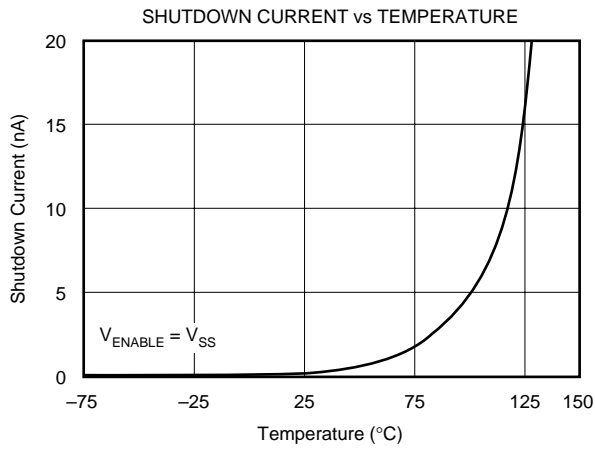

TYPICAL CHARACTERISTICS (Cont.)

At $T_A = +25^\circ\text{C}$, $V_{\text{ENABLE}} = V_{\text{DD}}$, $V_S = +5\text{V}$, $R_L = 10\text{k}\Omega$, unless otherwise noted.

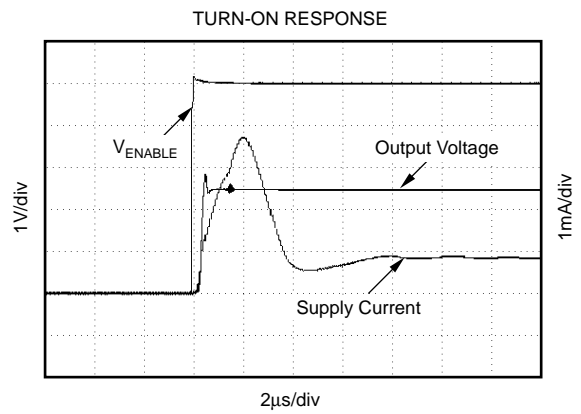
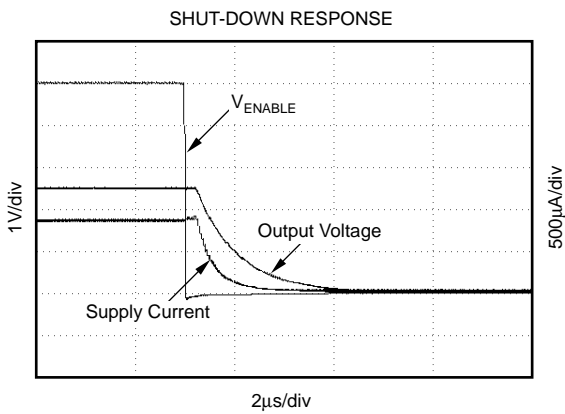
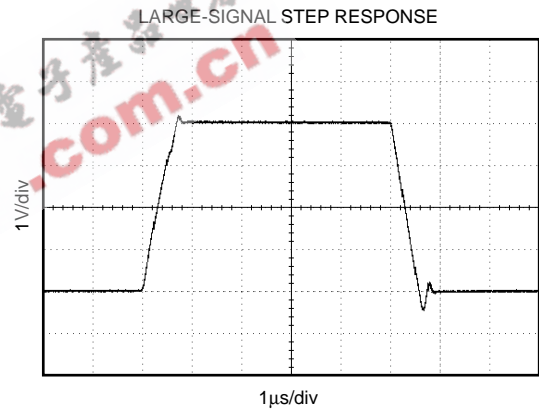
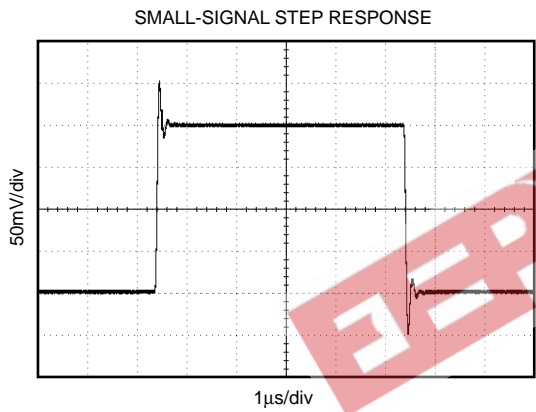
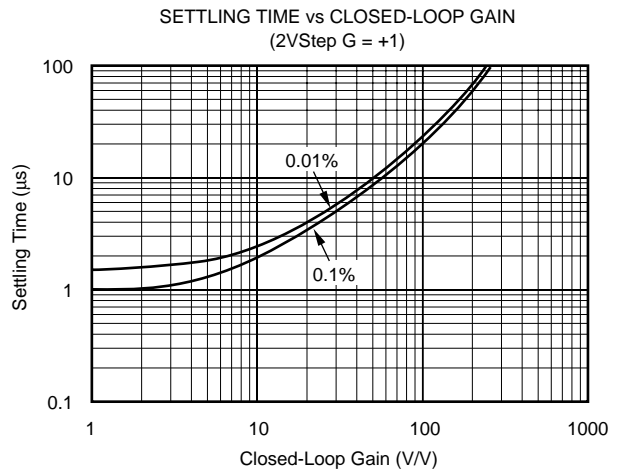
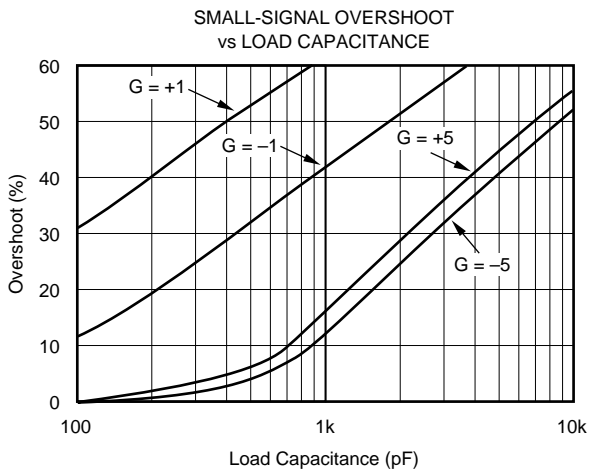

APPLICATIONS INFORMATION

OPA341 series op amps are fabricated on a state-of-the-art 0.6-micron CMOS process. They are unity-gain stable and suitable for a wide range of general-purpose applications.

Rail-to-rail I/O make them ideal for driving sampling A/D converters. In addition, excellent ac performance makes them well suited for audio applications. The class AB output stage is capable of driving 600Ω loads connected to any point between V+ and ground. Rail-to-rail input and output swing significantly increases dynamic range, especially in low-supply applications. Figure 1 shows the input and output waveforms for the OPA341 in unity-gain configuration. Operation is from a single +5V supply with a 10kΩ load connected to V_S/2. The input is a 5Vp-p sinusoid. Output voltage is approximately 4.98Vp-p. Power-supply pins should be bypassed with 0.01μF ceramic capacitors.

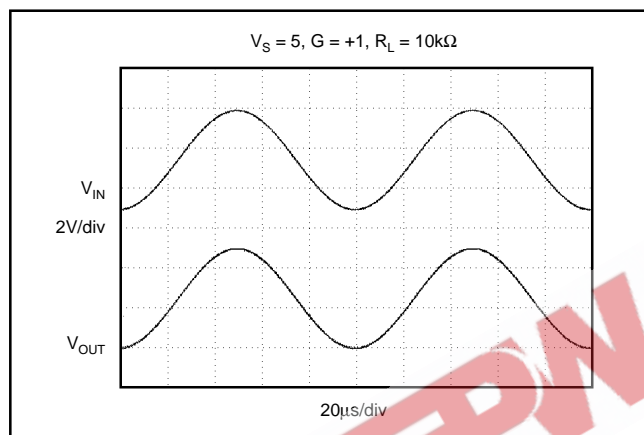

FIGURE 1. Rail-to-Rail Input and Output.

OPERATING VOLTAGE

OPA341 series op amps are fully specified from +2.7V to +5.5V. However, supply voltage may range from +2.5V to +5.5V. Parameters are tested over the specified supply range—a unique feature of the OPA341 series. In addition, many specifications apply from -55°C to +125°C. Most behavior remains virtually unchanged throughout the full operating voltage range. Parameters that vary significantly with operating voltages or temperature are shown in the Typical Characteristics.

RAIL-TO-RAIL INPUT

The input common-mode voltage range of the OPA341 series extends 300mV beyond the supply rails. This is achieved with a complementary input stage—an N-channel input differential pair in parallel with a P-channel differential pair, as shown in Figure 2. The N-channel pair is active for input voltages close to the positive rail, typically (V+) - 1.3V to 300mV above the positive supply. The P-channel pair is on for inputs from 300mV below the negative supply to approximately (V+) - 1.3V.

There is a small transition region, typically (V+) - 1.5V to (V+) - 1.1V, in which both input pairs are on. This 400mV transition region can vary ±300mV with process variation. Thus, the transition region (both stages on) can range from (V+) - 1.8V to (V+) - 1.4V on the low end, up to (V+) - 1.2V to (V+) - 0.8V on the high end. Within the 400mV transition region PSRR, CMRR, offset voltage, offset drift, and THD may be degraded compared to operation outside this region.

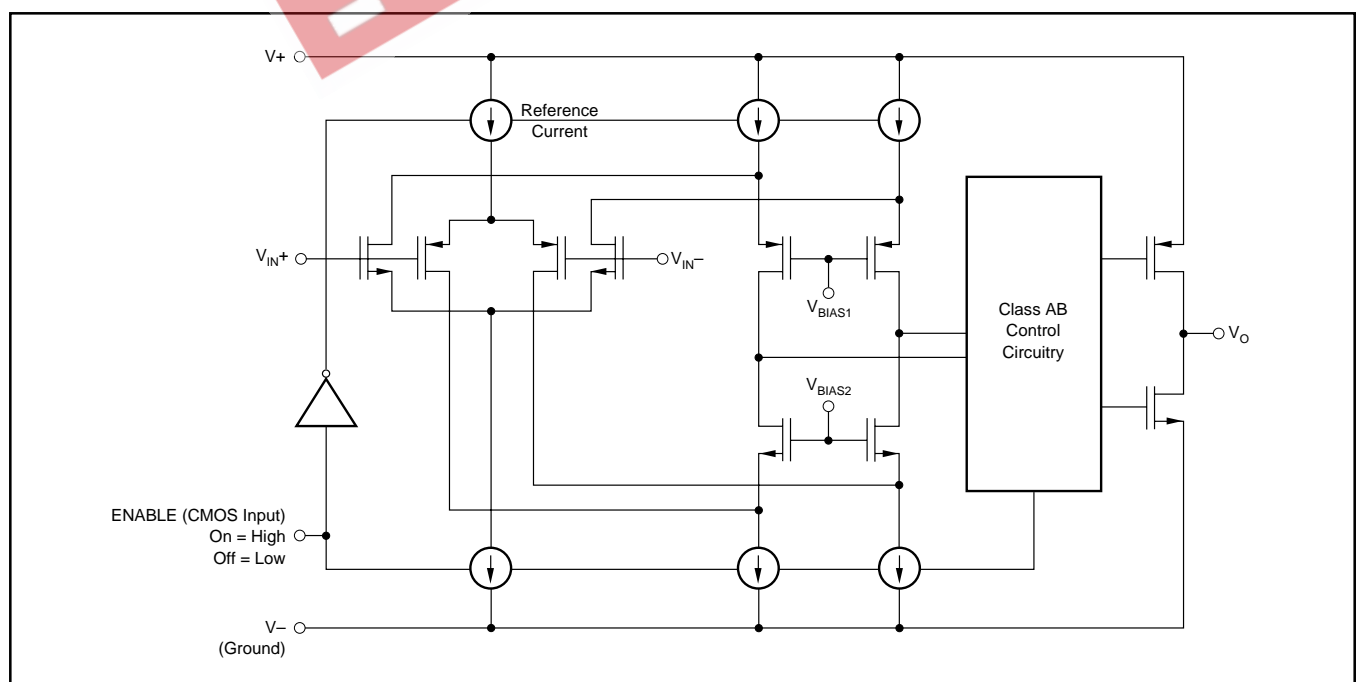

FIGURE 2. Simplified Schematic.

A double-folded cascode adds the signal from the two input pairs and presents a differential signal to the class AB output stage. Normally, input bias current is approximately 600fA, however, input voltages exceeding the power supplies by more than 300mV can cause excessive current to flow in or out of the input pins. Momentary voltages greater than 300mV beyond the power supply can be tolerated if the current on the input pins is limited to 10mA. This is easily accomplished with an input resistor, as shown in Figure 3. Many input signals are inherently current-limited to less than 10mA, therefore, a limiting resistor is not required.

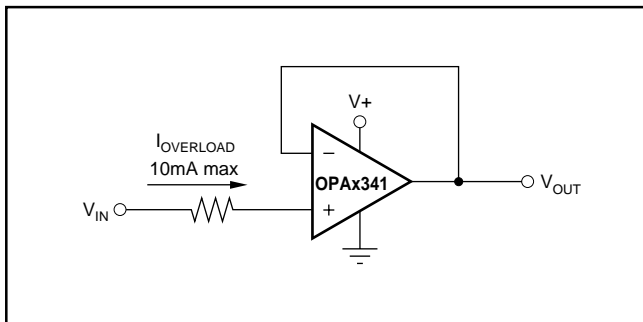

FIGURE 3. Input Current Protection for Voltages Exceeding the Supply Voltage.

RAIL-TO-RAIL OUTPUT

A class AB output stage with common-source transistors is used to achieve rail-to-rail output. For light resistive loads ($> 50k\Omega$), the output voltage is typically a few millivolts from the supply rails. With moderate resistive loads ($2k\Omega$ to $50k\Omega$), the output can swing to within a few tens of millivolts from the supply rails and maintain high open-loop gain. See the typical characteristic “Output Voltage Swing vs Output Current.”

CAPACITIVE LOAD AND STABILITY

OPA341 series op amps can drive a wide range of capacitive loads. However, all op amps under certain conditions may become unstable. Op amp configurations, gain, and load value are just a few of the factors to consider when determining stability. An op amp in unity-gain configuration is the most susceptible to the effects of capacitive load. The

capacitive load reacts with the op amp’s output resistance, along with any additional load resistance, to create a pole in the small-signal response which degrades the phase margin. In unity gain, OPA341 series op amps perform well, with a pure capacitive load up to approximately 1000pF. Increasing gain enhances the amplifier’s ability to drive more capacitance. See the typical characteristic “Small-Signal Overshoot vs Capacitive Load.”

One method of improving capacitive load drive in the unity-gain configuration is to insert a 10Ω to 20Ω resistor in series with the output, as shown in Figure 4. This significantly reduces ringing with large capacitive loads. However, if there is a resistive load in parallel with the capacitive load, R_S creates a voltage divider. This introduces a DC error at the output and slightly reduces output swing. This error may be insignificant. For instance, with $R_L = 10k\Omega$ and $R_S = 20\Omega$, there is only about a 0.2% error at the output.

DRIVING A/D CONVERTERS

OPA341 series op amps are optimized for driving medium speed (up to 100kHz) sampling A/D converters. However, they also offer excellent performance for higher-speed converters. The OPA341 series provides an effective means of buffering the A/D converter’s input capacitance and resulting charge injection while providing signal gain. For applications requiring high accuracy, the OPA340 series is recommended.

The OPA341 implements a power-saving shutdown feature particularly useful for low-power sampling applications. Figure 5 shows the OPA341 driving the ADS7816, a 12-bit micro-power sampling converter available in the tiny MSOP-8 package. With the OPA341 in non-inverting configuration, an RC network at the amplifier’s output is used as an anti-aliasing filter. By tying the enable of the OPA341 to the shutdown of the ADS7816, additional power-savings can be used for sampling applications. To effectively drive the ADS7816, timing delay was introduced between the two devices, see Figure 5. Alternative applications may need additional timing adjustments.

Figure 6 shows the OPA341 configured as a speech band-pass filter. Figure 7 shows the OPA341 configured as a transimpedance amplifier.

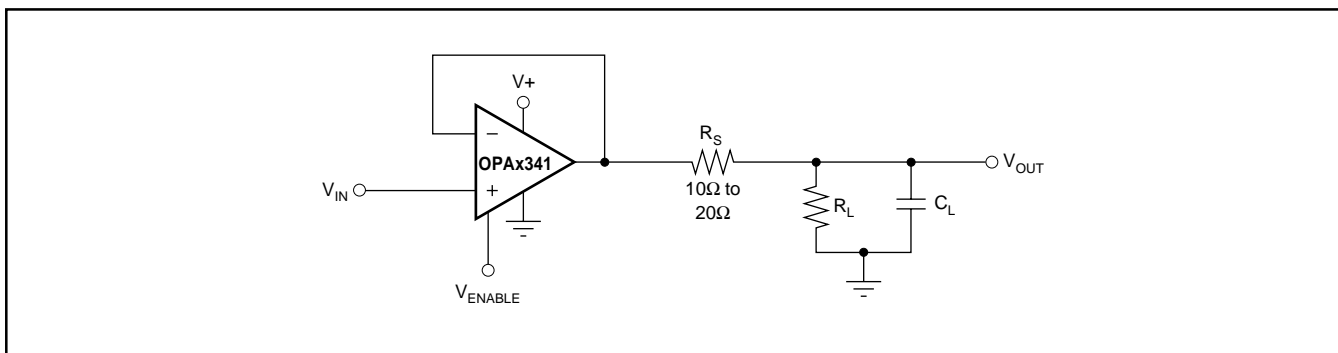

FIGURE 4. Series Resistor in Unity-Gain Configuration Improves Capacitive Load Drive.

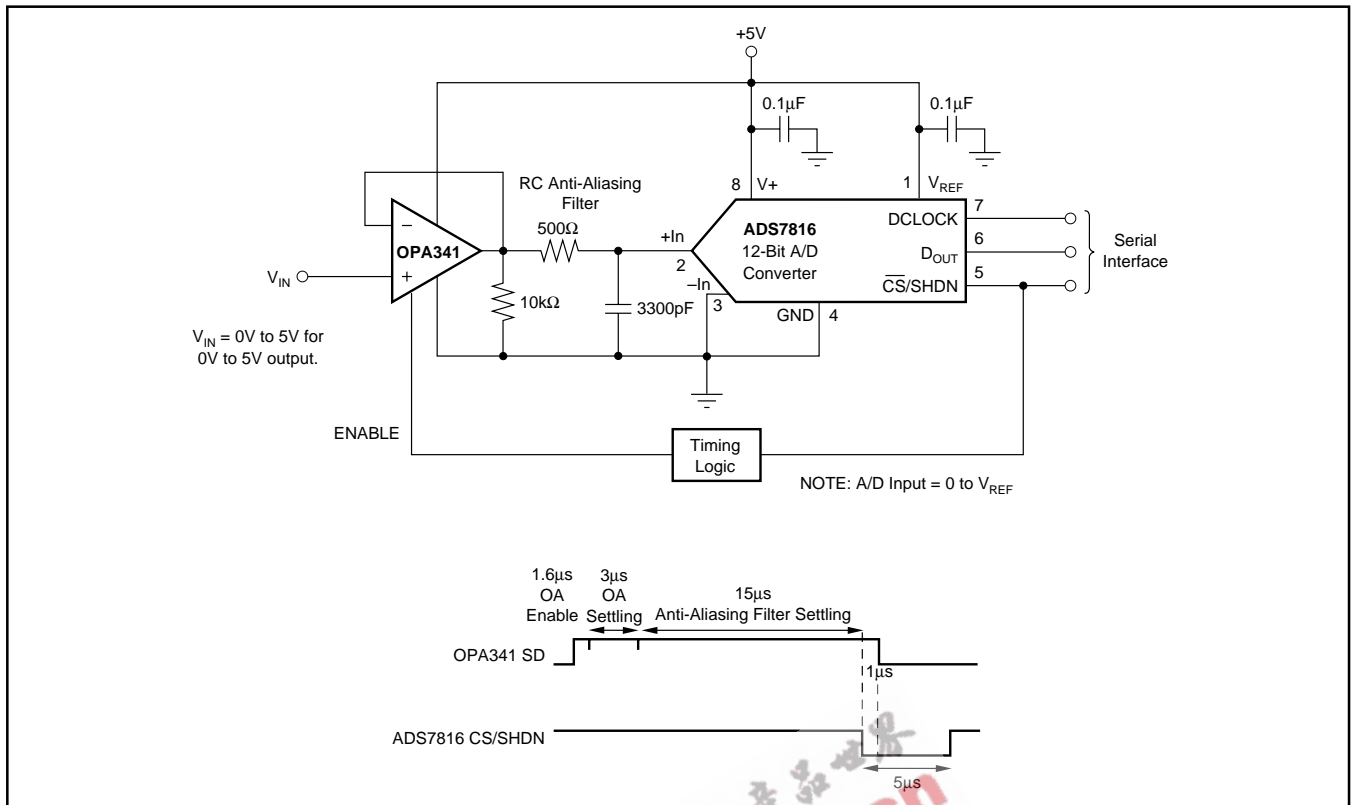

FIGURE 5. OPA341 in Noninverting Configuration Driving the ADS7816 with Timing Diagram.

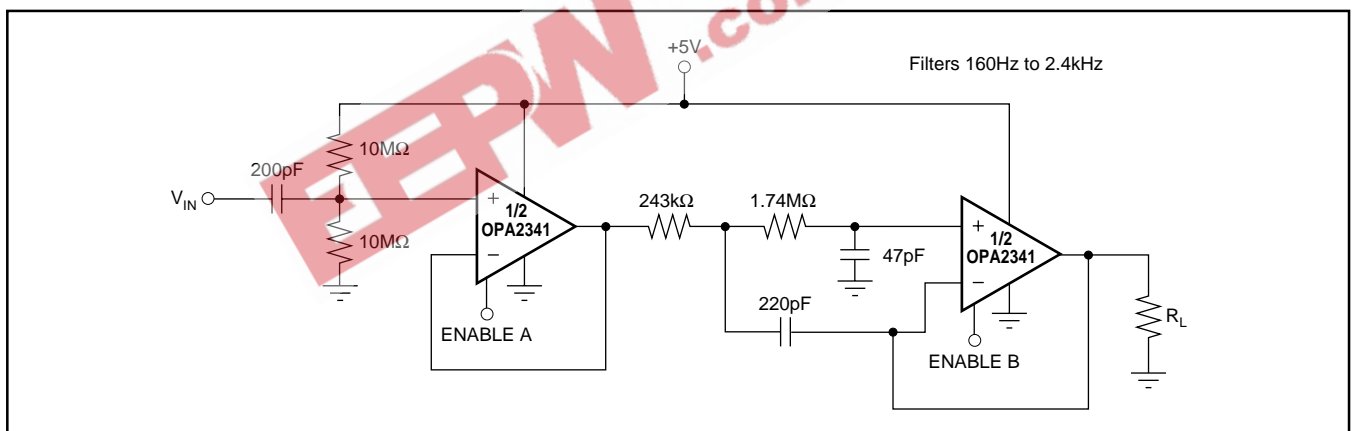

FIGURE 6. Speech Bandpass Filter.

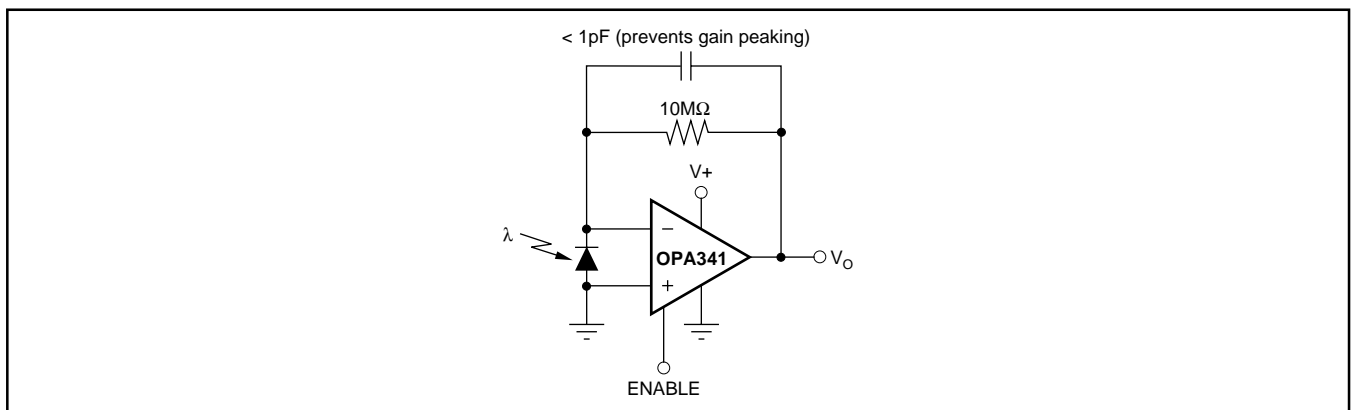

FIGURE 7. Transimpedance Amplifier.

PACKAGING INFORMATION

Orderable Device	Status ⁽¹⁾	Package Type	Package Drawing	Pins	Package Qty	Eco Plan ⁽²⁾	Lead/Ball Finish	MSL Peak Temp ⁽³⁾
OPA2341DGSA/250	ACTIVE	MSOP	DGS	10	250	Green (RoHS & no Sb/Br)	CU NIPDAU	Level-2-260C-1 YEAR
OPA2341DGSA/250G4	ACTIVE	MSOP	DGS	10	250	Green (RoHS & no Sb/Br)	CU NIPDAU	Level-2-260C-1 YEAR
OPA341NA/250	ACTIVE	SOT-23	DBV	6	250	Green (RoHS & no Sb/Br)	CU NIPDAU	Level-2-260C-1 YEAR
OPA341NA/250G4	ACTIVE	SOT-23	DBV	6	250	Green (RoHS & no Sb/Br)	CU NIPDAU	Level-2-260C-1 YEAR
OPA341NA/3K	ACTIVE	SOT-23	DBV	6	3000	Green (RoHS & no Sb/Br)	CU NIPDAU	Level-2-260C-1 YEAR
OPA341NA/3KG4	ACTIVE	SOT-23	DBV	6	3000	Green (RoHS & no Sb/Br)	CU NIPDAU	Level-2-260C-1 YEAR
OPA341UA	ACTIVE	SOIC	D	8	100	Green (RoHS & no Sb/Br)	CU NIPDAU	Level-2-260C-1 YEAR
OPA341UAG4	ACTIVE	SOIC	D	8	100	Green (RoHS & no Sb/Br)	CU NIPDAU	Level-2-260C-1 YEAR

⁽¹⁾ The marketing status values are defined as follows:

ACTIVE: Product device recommended for new designs.

LIFEBUY: TI has announced that the device will be discontinued, and a lifetime-buy period is in effect.

NRND: Not recommended for new designs. Device is in production to support existing customers, but TI does not recommend using this part in a new design.

PREVIEW: Device has been announced but is not in production. Samples may or may not be available.

OBSOLETE: TI has discontinued the production of the device.

⁽²⁾ Eco Plan - The planned eco-friendly classification: Pb-Free (RoHS), Pb-Free (RoHS Exempt), or Green (RoHS & no Sb/Br) - please check <http://www.ti.com/productcontent> for the latest availability information and additional product content details.

TBD: The Pb-Free/Green conversion plan has not been defined.

Pb-Free (RoHS): TI's terms "Lead-Free" or "Pb-Free" mean semiconductor products that are compatible with the current RoHS requirements for all 6 substances, including the requirement that lead not exceed 0.1% by weight in homogeneous materials. Where designed to be soldered at high temperatures, TI Pb-Free products are suitable for use in specified lead-free processes.

Pb-Free (RoHS Exempt): This component has a RoHS exemption for either 1) lead-based flip-chip solder bumps used between the die and package, or 2) lead-based die adhesive used between the die and leadframe. The component is otherwise considered Pb-Free (RoHS compatible) as defined above.

Green (RoHS & no Sb/Br): TI defines "Green" to mean Pb-Free (RoHS compatible), and free of Bromine (Br) and Antimony (Sb) based flame retardants (Br or Sb do not exceed 0.1% by weight in homogeneous material)

⁽³⁾ MSL, Peak Temp. -- The Moisture Sensitivity Level rating according to the JEDEC industry standard classifications, and peak solder temperature.

Important Information and Disclaimer:The information provided on this page represents TI's knowledge and belief as of the date that it is provided. TI bases its knowledge and belief on information provided by third parties, and makes no representation or warranty as to the accuracy of such information. Efforts are underway to better integrate information from third parties. TI has taken and continues to take reasonable steps to provide representative and accurate information but may not have conducted destructive testing or chemical analysis on incoming materials and chemicals. TI and TI suppliers consider certain information to be proprietary, and thus CAS numbers and other limited information may not be available for release.

In no event shall TI's liability arising out of such information exceed the total purchase price of the TI part(s) at issue in this document sold by TI to Customer on an annual basis.

TAPE AND REEL INFORMATION

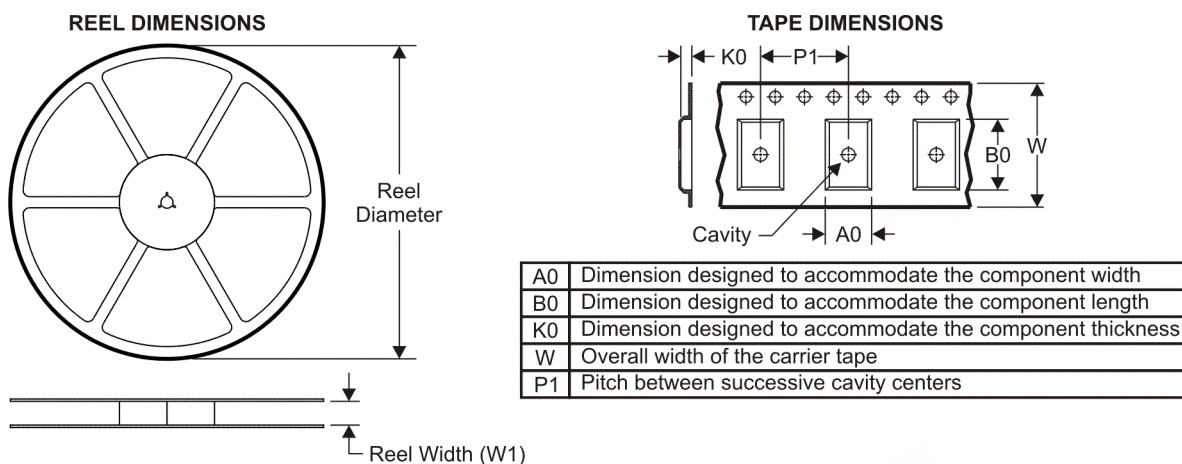

QUADRANT ASSIGNMENTS FOR PIN 1 ORIENTATION IN TAPE

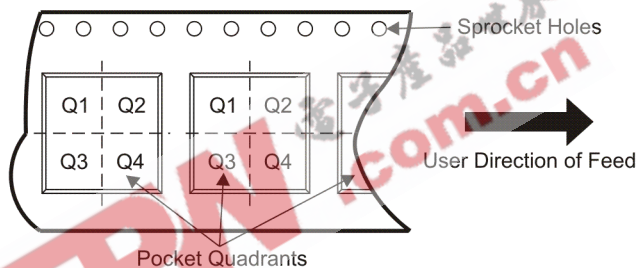

*All dimensions are nominal

Device	Package Type	Package Drawing	Pins	SPQ	Reel Diameter (mm)	Reel Width W1 (mm)	A0 (mm)	B0 (mm)	K0 (mm)	P1 (mm)	W (mm)	Pin1 Quadra
OPA2341DGSA/250	MSOP	DGS	10	250	180.0	12.4	5.3	3.4	1.4	8.0	12.0	Q1
OPA341NA/250	SOT-23	DBV	6	250	180.0	8.4	3.2	3.1	1.39	4.0	8.0	Q3
OPA341NA/3K	SOT-23	DBV	6	3000	180.0	8.4	3.2	3.1	1.39	4.0	8.0	Q3

TAPE AND REEL BOX DIMENSIONS

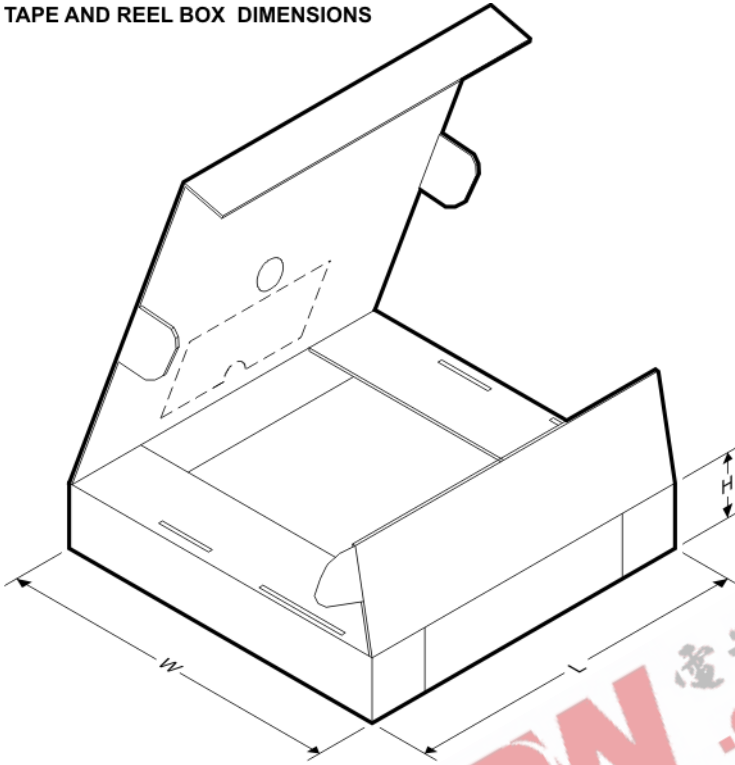

*All dimensions are nominal

Device	Package Type	Package Drawing	Pins	SPQ	Length (mm)	Width (mm)	Height (mm)
OPA2341DGSA/250	MSOP	DGS	10	250	184.0	184.0	50.0
OPA341NA/250	SOT-23	DBV	6	250	190.5	212.7	31.8
OPA341NA/3K	SOT-23	DBV	6	3000	190.5	212.7	31.8

IMPORTANT NOTICE

Texas Instruments Incorporated and its subsidiaries (TI) reserve the right to make corrections, modifications, enhancements, improvements, and other changes to its products and services at any time and to discontinue any product or service without notice. Customers should obtain the latest relevant information before placing orders and should verify that such information is current and complete. All products are sold subject to TI's terms and conditions of sale supplied at the time of order acknowledgment.

TI warrants performance of its hardware products to the specifications applicable at the time of sale in accordance with TI's standard warranty. Testing and other quality control techniques are used to the extent TI deems necessary to support this warranty. Except where mandated by government requirements, testing of all parameters of each product is not necessarily performed.

TI assumes no liability for applications assistance or customer product design. Customers are responsible for their products and applications using TI components. To minimize the risks associated with customer products and applications, customers should provide adequate design and operating safeguards.

TI does not warrant or represent that any license, either express or implied, is granted under any TI patent right, copyright, mask work right, or other TI intellectual property right relating to any combination, machine, or process in which TI products or services are used. Information published by TI regarding third-party products or services does not constitute a license from TI to use such products or services or a warranty or endorsement thereof. Use of such information may require a license from a third party under the patents or other intellectual property of the third party, or a license from TI under the patents or other intellectual property of TI.

Reproduction of TI information in TI data books or data sheets is permissible only if reproduction is without alteration and is accompanied by all associated warranties, conditions, limitations, and notices. Reproduction of this information with alteration is an unfair and deceptive business practice. TI is not responsible or liable for such altered documentation. Information of third parties may be subject to additional restrictions.

Resale of TI products or services with statements different from or beyond the parameters stated by TI for that product or service voids all express and any implied warranties for the associated TI product or service and is an unfair and deceptive business practice. TI is not responsible or liable for any such statements.

TI products are not authorized for use in safety-critical applications (such as life support) where a failure of the TI product would reasonably be expected to cause severe personal injury or death, unless officers of the parties have executed an agreement specifically governing such use. Buyers represent that they have all necessary expertise in the safety and regulatory ramifications of their applications, and acknowledge and agree that they are solely responsible for all legal, regulatory and safety-related requirements concerning their products and any use of TI products in such safety-critical applications, notwithstanding any applications-related information or support that may be provided by TI. Further, Buyers must fully indemnify TI and its representatives against any damages arising out of the use of TI products in such safety-critical applications.

TI products are neither designed nor intended for use in military/aerospace applications or environments unless the TI products are specifically designated by TI as military-grade or "enhanced plastic." Only products designated by TI as military-grade meet military specifications. Buyers acknowledge and agree that any such use of TI products which TI has not designated as military-grade is solely at the Buyer's risk, and that they are solely responsible for compliance with all legal and regulatory requirements in connection with such use.

TI products are neither designed nor intended for use in automotive applications or environments unless the specific TI products are designated by TI as compliant with ISO/TS 16949 requirements. Buyers acknowledge and agree that, if they use any non-designated products in automotive applications, TI will not be responsible for any failure to meet such requirements.

Following are URLs where you can obtain information on other Texas Instruments products and application solutions:

Products

Amplifiers	amplifier.ti.com
Data Converters	dataconverter.ti.com
DSP	dsp.ti.com
Clocks and Timers	www.ti.com/clocks
Interface	interface.ti.com
Logic	logic.ti.com
Power Mgmt	power.ti.com
Microcontrollers	microcontroller.ti.com
RFID	www.ti-rfid.com
RF/IF and ZigBee® Solutions	www.ti.com/lprf

Applications

Audio	www.ti.com/audio
Automotive	www.ti.com/automotive
Broadband	www.ti.com/broadband
Digital Control	www.ti.com/digitalcontrol
Medical	www.ti.com/medical
Military	www.ti.com/military
Optical Networking	www.ti.com/opticalnetwork
Security	www.ti.com/security
Telephony	www.ti.com/telephony
Video & Imaging	www.ti.com/video
Wireless	www.ti.com/wireless

Mailing Address: Texas Instruments, Post Office Box 655303, Dallas, Texas 75265
Copyright © 2008, Texas Instruments Incorporated