

LED and Photosensor Pair

Types OPS695, OPS696, OPS697, OPS698

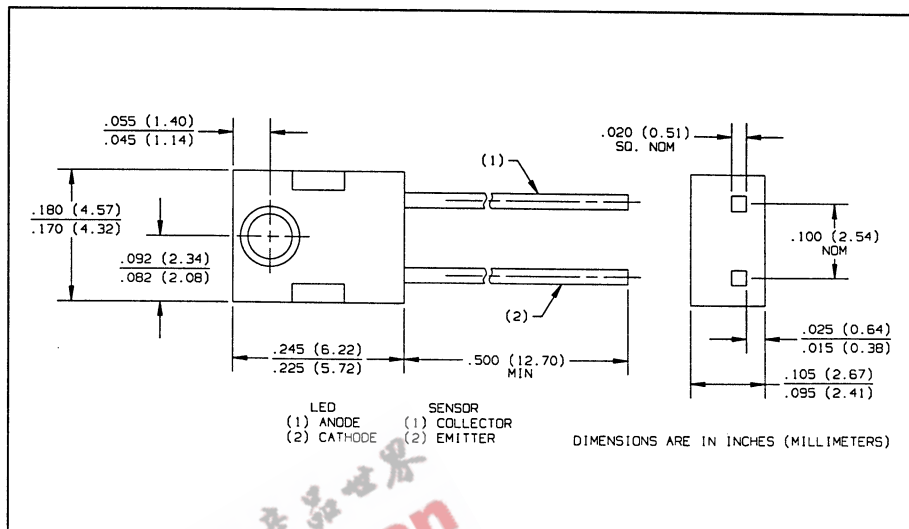
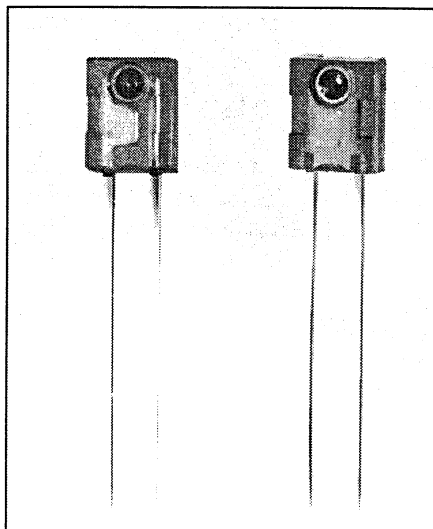

Features

- Lateral side-looking plastic package
- High current transfer ratio
- Low cost plastic package

Description

The OPS695 through OPS698 each consist of a gallium arsenide infrared emitting diode (OP145) and an NPN silicon phototransistor (OP555) mounted in matched lateral side-looking plastic packages. Matched pairs are desirable where the application is unique and the quantity required does not justify assembly tooling costs. If separation between the LED and the sensor is greater than two times the specified $I_{C(ON)}$ distance, proper alignment becomes critical. It should be remembered that the sensor is sensitive to ambient light. Although sold as pairs, emitters are packaged separately from sensors for ease of handling.

Absolute Maximum Ratings ($T_A = 25^\circ\text{C}$ unless otherwise noted)

Storage and Operating Temperature -40°C to $+100^\circ\text{C}$
Lead Soldering Temperature [1/16 inch (1.6 mm) from case for 5 sec. with soldering iron] 260°C (1)

Input Diode

Continuous Forward Current 50 mA
Peak Forward Current (1 μs pulse width, 300 pps) 3.0 A
Reverse Voltage 2.0 V
Power Dissipation 100 mW⁽²⁾

Output Phototransistor

Collector-Emitter Voltage 30 V
Emitter-Collector Voltage 5.0 V
Power Dissipation 100 mW⁽²⁾

Notes:

- (1) RMA flux is recommended. Duration can be extended to 10 sec. max when flow soldering. Max. 20 grams force may be applied to leads when soldering.
- (2) Derate linearly 1.33 mW/ $^\circ\text{C}$ above 25°C .
- (3) Distance from lens tip to lens tip is 0.125 inches (3.18 mm).

Types OPS695, OPS696, OPS697, OPS698

Electrical Characteristics ($T_A = 25^\circ\text{C}$ unless otherwise noted)

SYMBOL	PARAMETER	MIN	TYP	MAX	UNITS	TEST CONDITIONS
Input Diode						
V_F	Forward Voltage			1.60	V	$I_F = 20\text{ mA}$
I_R	Reverse Current			100	μA	$V_R = 2\text{ V}$
Output Phototransistor						
$V_{(BR)CEO}$	Collector-Emitter Breakdown Voltage	30			V	$I_C = 100\ \mu\text{A}, E_e = 0$
$V_{(BR)ECO}$	Emitter-Collector Breakdown Voltage	5.0			V	$I_E = 100\ \mu\text{A}, E_e = 0$
I_{CEO}	Dark Current			100	nA	$V_{CE} = 10\text{ V}, E_e = 0$
Coupled						
$V_{CE(SAT)}$	Saturation Voltage			0.40	V	$I_F = 20\text{ mA}, I_C = 50\ \mu\text{A}^{(3)}$
$I_{C(ON)}$	On-State Collector Current	OPS695 OPS696 OPS697 OPS698	100 500 1.0 2.0		μA μA mA mA	$V_{CE} = 10\text{ V}, I_F = 20\text{ mA}^{(3)}$

Typical Performance Curves

Coupling Characteristics of OP145 and OP555

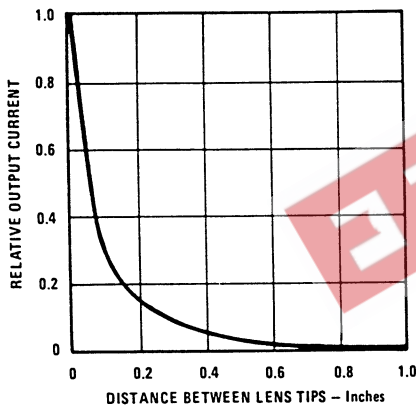

Forward Current vs Forward Voltage

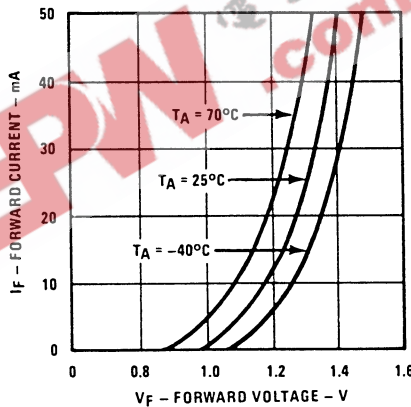

Dark Current vs Free Air Temperature

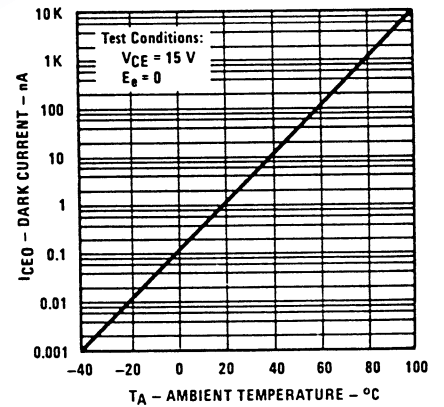

Relative Output Current vs Free Air Temperature

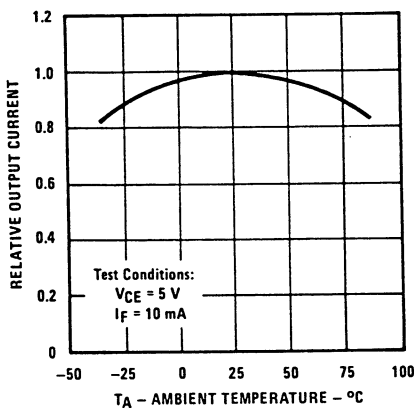

Normalized Collector Current vs Angular Displacement

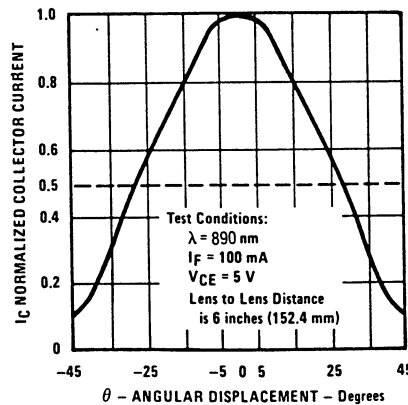

Relative Power Output vs Forward Current (LED)

