

**OPA631
OPA632**

For most current data sheet and other product information, visit www.burr-brown.com

SpeedPLUS™ Low Power, Single-Supply OPERATIONAL AMPLIFIERS

FEATURES

- HIGH BANDWIDTH: 75MHz (G = +2)
- LOW SUPPLY CURRENT: 6mA
- ZERO POWER DISABLE (OPA632)
- +3V AND +5V OPERATION
- INPUT RANGE INCLUDES GROUND
- 4.8V OUTPUT SWING ON +5V SUPPLY
- HIGH SLEW RATE: 100V/μs
- LOW INPUT VOLTAGE NOISE: 6nV/√Hz
- AVAILABLE IN SOT23 PACKAGE

APPLICATIONS

- SINGLE SUPPLY ADC INPUT BUFFER
- SINGLE SUPPLY VIDEO LINE DRIVER
- CCD IMAGING CHANNELS
- LOW POWER ULTRASOUND
- PLL INTEGRATORS
- PORTABLE CONSUMER ELECTRONICS

DESCRIPTION

The OPA631 and OPA632 are low power, high-speed, voltage-feedback amplifiers designed to operate on a single +3V or +5V supply. Operation on ±5V or +10V supplies is also supported. The input range extends below ground and to within 1V of the positive supply. Using complementary common-emitter outputs provides an output swing to within 30mV of ground and 130mV of the positive supply. The high output drive current and low differential gain and phase errors also make them ideal for single-supply consumer video products.

Low distortion operation is ensured by the high gain bandwidth (68MHz) and slew rate (100V/μs), making the OPA631 and OPA632 ideal input buffer stages to 3V and 5V CMOS converters. Unlike other low power, single-supply amplifiers, distortion performance improves as the signal swing is decreased. A low 6nV input voltage noise supports wide dynamic range operation. Channel multiplexing or system power reduction can be achieved using the high speed disable line. Power dissipation can be reduced to zero by taking the disable line High.

The OPA631 and OPA632 are available in an industry-standard SO-8 package. The OPA631 is also available in an ultra-small SOT23-5 package, while the OPA632 is available in the SOT23-6. Where higher full-power bandwidth and lower distortion are required in a single-supply operational amplifier, consider the OPA634 and OPA635.

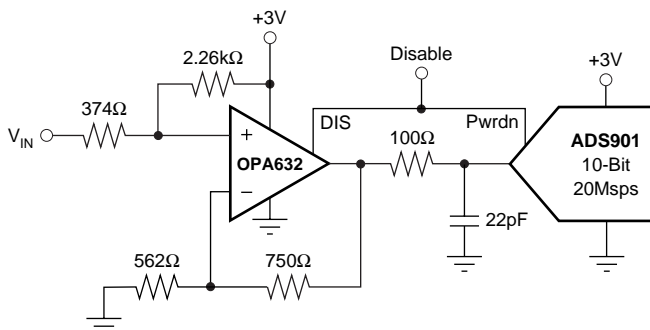

RELATED PRODUCTS

	SINGLES	DUALS
Medium Speed, No Disable With Disable	OPA631 OPA632	OPA2631 —
High Speed, No Disable With Disable	OPA634 OPA635	OPA2634 —

SPECIFICATIONS: $V_S = +5V$

At $T_A = 25^\circ C$, $G = +2$, $R_F = 750\Omega$, and $R_L = 150\Omega$ to $V_S/2$, unless otherwise noted (see Figure 1).

PARAMETER	CONDITIONS	OPA631U, N OPA632U, N				UNITS	MIN/ MAX	TEST LEVEL ⁽¹⁾
		TYP	GUARANTEED					
		+25°C	+25°C	0°C to 70°C	-40°C to +85°C			
AC PERFORMANCE (Figure 1)								
Small-Signal Bandwidth	$G = +2, V_O \leq 0.5V_{p-p}$	75	50	40	32	MHz	min	B
	$G = +5, V_O \leq 0.5V_{p-p}$	16	12	10	8.5	MHz	min	B
	$G = +10, V_O \leq 0.5V_{p-p}$	7.6	5.6	4.2	3.7	MHz	min	B
Gain Bandwidth Product	$G \geq +10$	68	51	40	36	MHz	min	B
Peaking at a Gain of +1	$V_O \leq 0.5V_{p-p}$	5	—	—	—	dB	typ	C
Slew Rate	$G = +2, 2V$ Step	100	64	52	47	V/ μs	min	B
Rise Time	0.5V Step	5.3	8.0	11	12.8	ns	max	B
Fall Time	0.5V Step	5.4	7.5	10	11.6	ns	max	B
Settling Time to 0.1%	$G = +2, 1V$ Step	17	28	38	42	ns	max	B
Spurious Free Dynamic Range	$V_O = 2V_{p-p}, f = 5MHz$	42	40	38	35	dBc	min	B
Input Voltage Noise	$f > 1MHz$	6.0	6.8	7.6	7.9	nV/ \sqrt{Hz}	max	B
Input Current Noise	$f > 1MHz$	1.9	2.6	2.9	3.6	pA/ \sqrt{Hz}	max	B
NTSC Differential Gain		0.5	—	—	—	%	typ	C
NTSC Differential Phase		1.2	—	—	—	degrees	typ	C
DC PERFORMANCE								
Open-Loop Voltage Gain		62	56	50	46	dB	min	A
Input Offset Voltage		2.5	6	8	11	mV	max	A
Average Offset Voltage Drift		—	—	—	50	$\mu V/^\circ C$	max	B
Input Bias Current	$V_{CM} = 2.0V$	11	21	27	40	μA	max	B
Input Offset Current	$V_{CM} = 2.0V$	0.3	1	1.3	2	μA	max	B
Input Offset Current Drift		—	—	—	7	nA/ $^\circ C$	max	B
INPUT								
Least Positive Input Voltage		-0.5	-0.1	-0.1	-0.1	V	max	B
Most Positive Input Voltage		4.0	3.7	3.7	3.5	V	min	A
Common-Mode Rejection Ratio (CMRR)	Input Referred	74	70	68	60	dB	min	A
Input Impedance								
Differential-Mode		10 2.1	—	—	—	k Ω pF	typ	C
Common-Mode		400 1.2	—	—	—	k Ω pF	typ	C
OUTPUT								
Least Positive Output Voltage	$R_L = 1k\Omega$ to 2.5V	0.03	0.06	0.09	0.12	V	max	B
	$R_L = 150\Omega$ to 2.5V	0.16	0.17	0.20	1.7	V	max	A
Most Positive Output Voltage	$R_L = 1k\Omega$ to 2.5V	4.87	4.8	4.7	4.6	V	min	B
	$R_L = 150\Omega$ to 2.5V	4.60	4.4	4.4	3.1	V	min	A
Current Output, Sourcing		80	25	20	5	mA	min	A
Current Output, Sinking		90	38	24	10	mA	min	A
Short-Circuit Current (output shorted to either supply)		100	—	—	—	mA	typ	C
Closed-Loop Output Impedance	$G = +2, f \leq 100kHz$	0.2	—	—	—	Ω	typ	C
DISABLE (OPA632 only)								
On Voltage (device enabled Low)		1.0	1.0	1.0	1.0	V	min	A
Off Voltage (device disabled High)		3.7	3.8	4.0	4.2	V	max	A
On Disable Current (DIS pin)		70	110	120	120	μA	max	A
Off Disable Current (DIS pin)		0	—	—	—	μA	typ	C
Disabled Quiescent Current		0	20	25	30	μA	max	A
Disable Time		100	—	—	—	ns	typ	C
Enable Time		60	—	—	—	ns	typ	C
Off Isolation	$f = 5MHz, Input$ to Output	70	—	—	—	dB	typ	C
POWER SUPPLY								
Minimum Operating Voltage		—	2.7	2.7	2.7	V	min	A
Maximum Operating Voltage		—	10.5	10.5	10.5	V	max	A
Maximum Quiescent Current	$V_S = +5V$	6	6.4	6.7	6.9	mA	max	A
Minimum Quiescent Current	$V_S = +5V$	6	5.8	5.5	4.8	mA	min	A
Power Supply Rejection Ratio (PSRR)	Input Referred	59	52	49	48	dB	min	A
THERMAL CHARACTERISTICS								
Specification: U, N		-40 to +85				$^\circ C$	typ	C
Thermal Resistance								
U SO-8		125				$^\circ C/W$	typ	C
N SOT23-5, SOT23-6		150				$^\circ C/W$	typ	C

NOTE: (1) Test Levels: (A) 100% tested at 25°C. Over temperature limits by characterization and simulation. (B) Limits set by characterization and simulation. (C) Typical value only for information.

SPECIFICATIONS: $V_S = +3V$

At $T_A = 25^\circ\text{C}$, $G = +2$ and $R_L = 150\Omega$ to $V_S/2$, unless otherwise noted (see Figure 2).

PARAMETER	CONDITIONS	OPA631U, N OPA632U, N			UNITS	MIN/ MAX	TEST LEVEL ⁽¹⁾
		TYP	GUARANTEED				
		+25°C	+25°C	0°C to 70°C			
AC PERFORMANCE (Figure 2)							
Small-Signal Bandwidth	$G = +2, V_O \leq 0.5V_{p-p}$	61	45	35	MHz	min	B
	$G = +5, V_O \leq 0.5V_{p-p}$	15	11	9	MHz	min	B
	$G = +10, V_O \leq 0.5V_{p-p}$	7.7	4.6	4.0	MHz	min	B
Gain Bandwidth Product	$G \geq +10$	63	47	34	MHz	min	B
Peaking at a Gain of +1	$V_O \leq 0.5V_{p-p}$	5	—	—	dB	typ	C
Slew Rate	1V Step	95	52	46	V/ μs	min	B
Rise Time	0.5V Step	5.6	9	11.3	ns	max	B
Fall Time	0.5V Step	5.6	9	11.3	ns	max	B
Settling Time to 0.1%	1V Step	40	63	85	ns	max	B
Spurious Free Dynamic Range	$V_O = 1V_{p-p}, f = 5\text{MHz}$	44	37	34	dBc	min	B
Input Voltage Noise	$f > 1\text{MHz}$	6.2	7.0	7.8	nV/ $\sqrt{\text{Hz}}$	max	B
Input Current Noise	$f > 1\text{MHz}$	2.0	2.6	2.9	pA/ $\sqrt{\text{Hz}}$	max	B
DC PERFORMANCE							
Open-Loop Voltage Gain		60	54	50	dB	min	A
Input Offset Voltage		0.5	3.5	4	mV	max	A
Average Offset Voltage Drift		—	—	45	$\mu\text{V}/^\circ\text{C}$	max	B
Input Bias Current	$V_{CM} = 1.0V$	12	21	26	μA	max	B
Input Offset Current	$V_{CM} = 1.0V$	0.3	1	1.3	μA	max	B
Input Offset Current Drift		—	—	2	nA/ $^\circ\text{C}$	max	B
INPUT							
Least Positive Input Voltage		-0.5	-0.3	-0.1	V	max	B
Most Positive Input Voltage		2	1.75	1.3	V	min	A
Common-Mode Rejection Ratio (CMRR)	Input Referred	72	66	65	dB	min	A
Input Impedance							
Differential-Mode		10 2.1	—	—	k Ω p	typ	C
Common-Mode		400 1.2	—	—	k Ω p	typ	C
OUTPUT							
Least Positive Output Voltage	$R_L = 1k\Omega$ to 1.5V	0.03	0.05	0.05	V	max	A
	$R_L = 150\Omega$ to 1.5V	0.05	0.15	0.16	V	max	A
Most Positive Output Voltage	$R_L = 1k\Omega$ to 1.5V	2.95	2.85	2.84	V	min	A
	$R_L = 150\Omega$ to 1.5V	2.85	2.66	2.60	V	min	A
Current Output, Sourcing		55	21	14	mA	min	A
Current Output, Sinking		55	21	14	mA	min	A
Short Circuit Current (output shorted to either supply)		80	—	—	mA	typ	C
Closed-Loop Output Impedance	Figure 2, $f < 100\text{kHz}$	0.2	—	—	Ω	typ	C
DISABLE (OPA632 only)							
On Voltage (device enabled Low)		1.0	1.0	1.0	V	min	A
Off Voltage (device disabled High)		1.7	1.8	1.8	V	max	A
On Disable Current (DIS pin)		66	100	110	μA	max	A
Off Disable Current (DIS pin)		0	—	—	μA	typ	C
Disabled Quiescent Current		0	20	25	μA	max	A
Disable Time		100	—	—	ns	typ	C
Enable Time		60	—	—	ns	typ	C
Off Isolation	$f = 5\text{MHz}$, Input to Output	70	—	—	dB	typ	C
POWER SUPPLY							
Minimum Operating Voltage		—	2.7	2.7	V	min	A
Maximum Operating Voltage		—	10.5	10.5	V	max	A
Maximum Quiescent Current	$V_S = +3V$	5.3	5.7	6.2	mA	max	A
Minimum Quiescent Current	$V_S = +3V$	5.3	5.0	4.8	mA	min	A
Power Supply Rejection Ratio (PSRR)	Input Referred	57	50	48	dB	min	A
THERMAL CHARACTERISTICS							
Specification: U, N		-40 to +85			$^\circ\text{C}$	typ	C
Thermal Resistance							
U SO-8		125			$^\circ\text{C}/\text{W}$	typ	C
N SOT23-5, SOT23-6		150			$^\circ\text{C}/\text{W}$	typ	C

NOTE: (1) Test Levels: (A) 100% tested at 25°C. Over temperature limits by characterization and simulation. (B) Limits set by characterization and simulation. (C) Typical value only for information.

The information provided herein is believed to be reliable; however, BURR-BROWN assumes no responsibility for inaccuracies or omissions. BURR-BROWN assumes no responsibility for the use of this information, and all use of such information shall be entirely at the user's own risk. Prices and specifications are subject to change without notice. No patent rights or licenses to any of the circuits described herein are implied or granted to any third party. BURR-BROWN does not authorize or warrant any BURR-BROWN product for use in life support devices and/or systems.

ABSOLUTE MAXIMUM RATINGS

Power Supply	+11V _{DC}
Internal Power Dissipation	See Thermal Analysis
Differential Input Voltage	±1.2V
Input Voltage Range	-0.5 to +V _S + 0.3V
Storage Temperature Range: P, U, N	-40°C to +125°C
Lead Temperature (soldering, 10s)	+300°C
Junction Temperature (T _J)	+175°C



ELECTROSTATIC DISCHARGE SENSITIVITY

Electrostatic discharge can cause damage ranging from performance degradation to complete device failure. Burr-Brown Corporation recommends that all integrated circuits be handled and stored using appropriate ESD protection methods.

ESD damage can range from subtle performance degradation to complete device failure. Precision integrated circuits may be more susceptible to damage because very small parametric changes could cause the device not to meet published specifications.

PIN CONFIGURATIONS

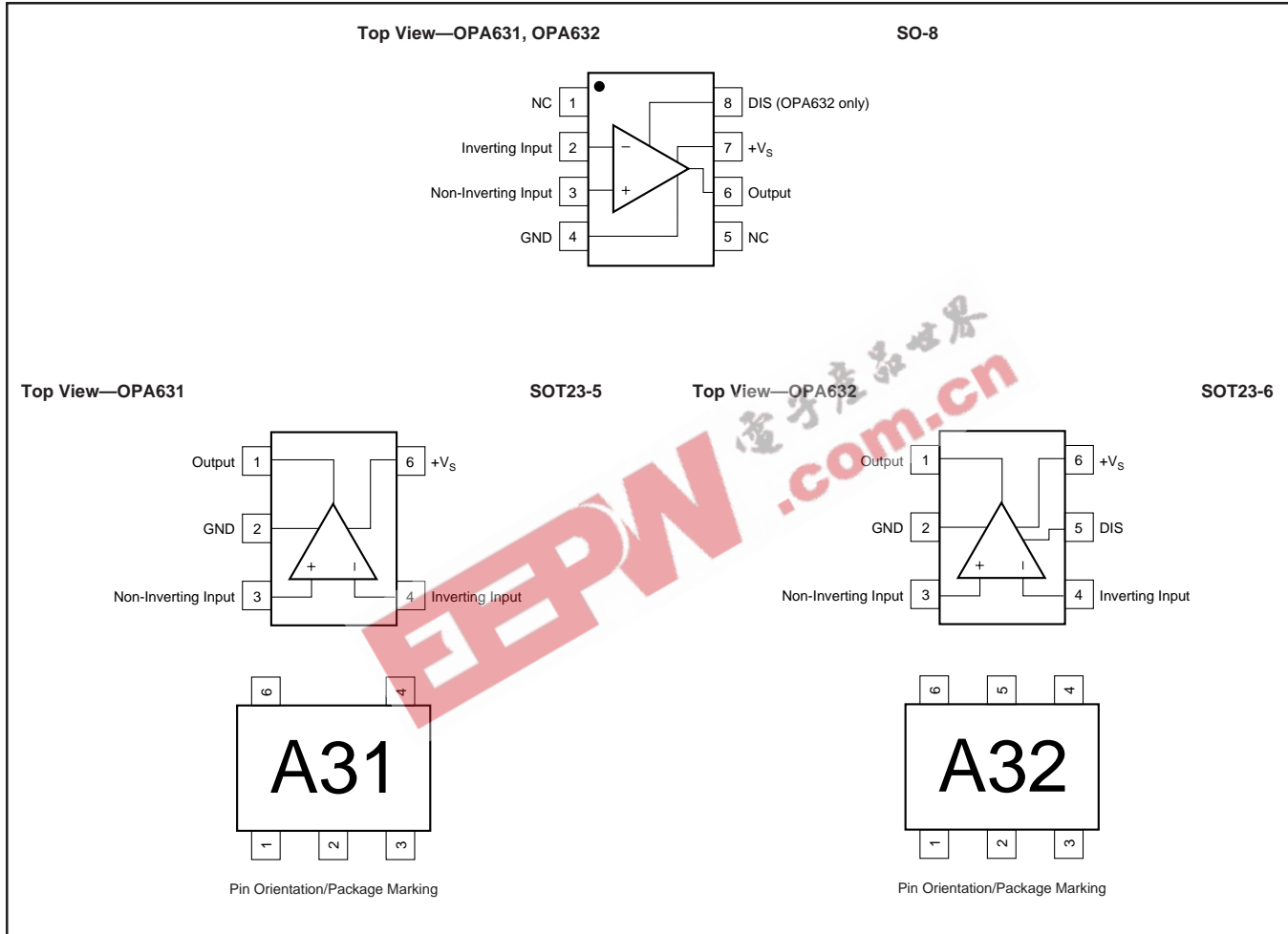

PACKAGE/ORDERING INFORMATION

PRODUCT	PACKAGE	PACKAGE DRAWING NUMBER ⁽¹⁾	SPECIFIED TEMPERATURE RANGE	PACKAGE MARKING	ORDERING NUMBER ⁽²⁾	TRANSPORT MEDIA
OPA631U "	SO-8 Surface-Mount "	182 "	-40°C to +85°C "	OPA631U "	OPA631U OPA631U/2K5	Rails Tape and Reel
OPA631N "	5-Lead SOT23-5 "	331 "	-40°C to +85°C "	A31 "	OPA631N/250 OPA631N/3K	Tape and Reel Tape and Reel
OPA632U "	SO-8 Surface-Mount "	182 "	-40°C to +85°C "	OPA632U "	OPA632U OPA632U/2K5	Rails Tape and Reel
OPA632N "	6-Lead SOT23-6 "	332 "	-40°C to +85°C "	A32 "	OPA632N/250 OPA632N/3K	Tape and Reel Tape and Reel

NOTES: (1) For detailed drawing and dimension table, please see end of data sheet, or Appendix C of Burr-Brown IC Data Book. (2) Models with a slash (/) are available only in Tape and Reel in the quantities indicated (e.g., /3K indicates 3000 devices per reel). Ordering 3000 pieces of "OPA632N/3K" will get a single 3000-piece Tape and Reel. For detailed Tape and Reel mechanical information, refer to Appendix B of Burr-Brown IC Data Book.

TYPICAL PERFORMANCE CURVES: $V_S = +5V$

At $T_A = 25^\circ C$, $G = +2$, $R_F = 750\Omega$, and $R_L = 150\Omega$ to $V_S/2$, unless otherwise noted (see Figure 1).

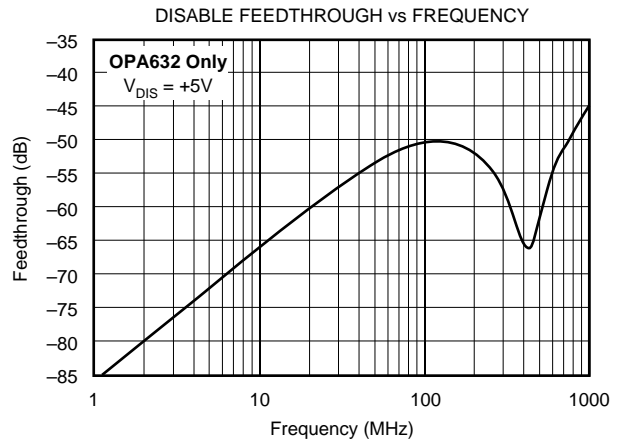
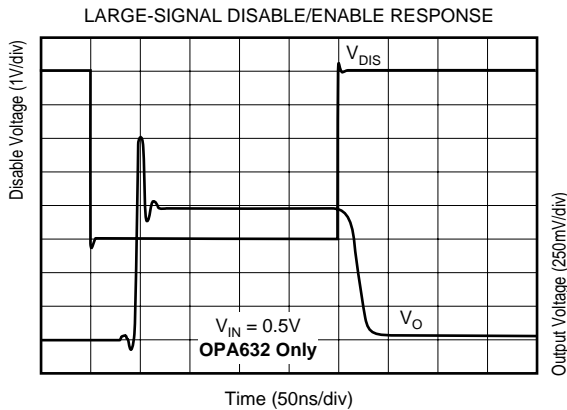
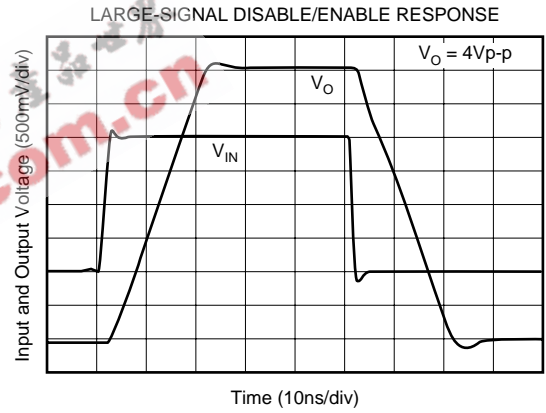
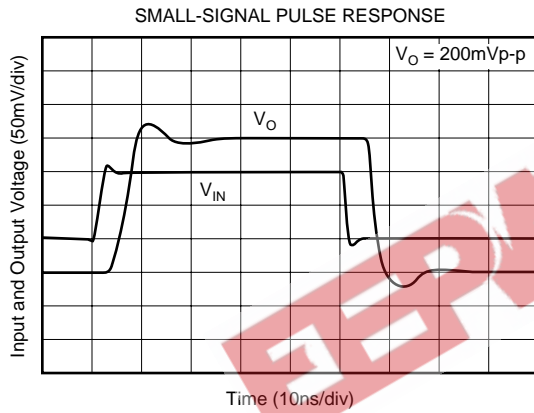
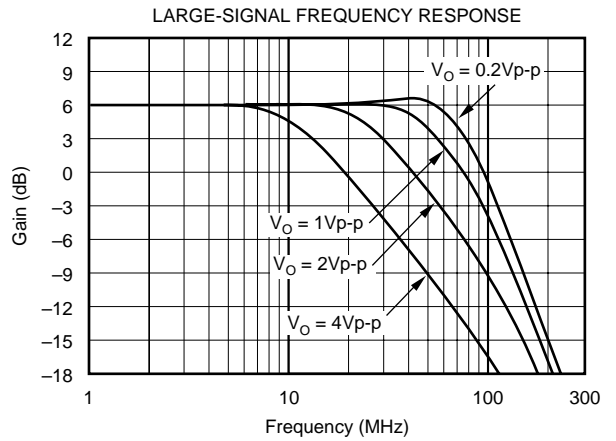
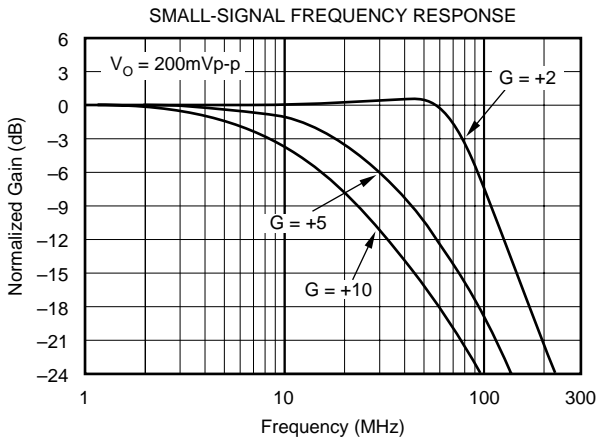

TYPICAL PERFORMANCE CURVES: $V_S = +5V$ (Cont.)

At $T_A = 25^\circ C$, $G = +2$, $R_F = 750\Omega$, and $R_L = 150\Omega$ to $V_S/2$, unless otherwise noted (see Figure 1).

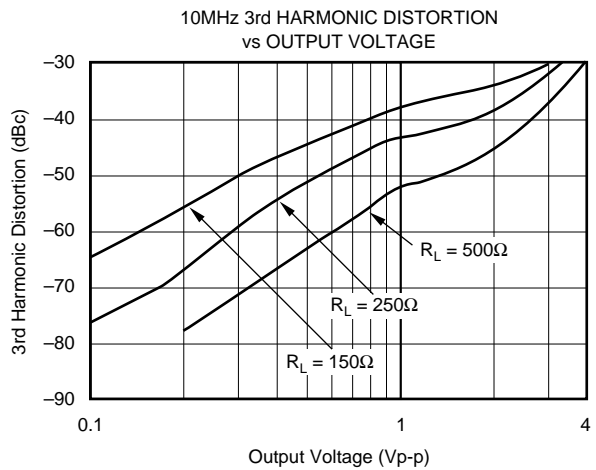
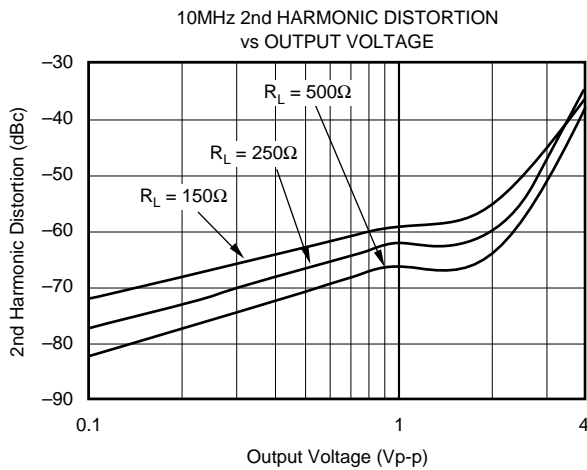
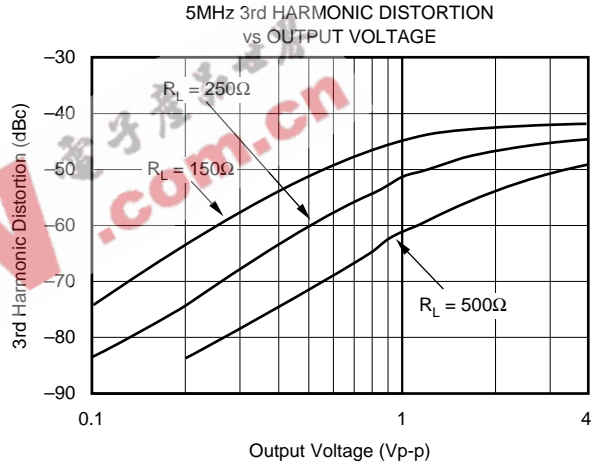
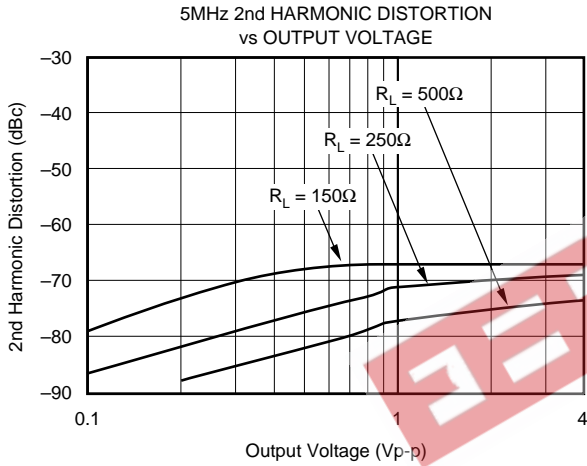
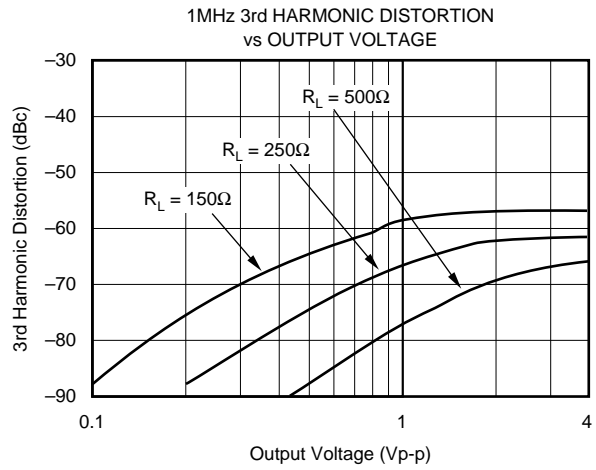
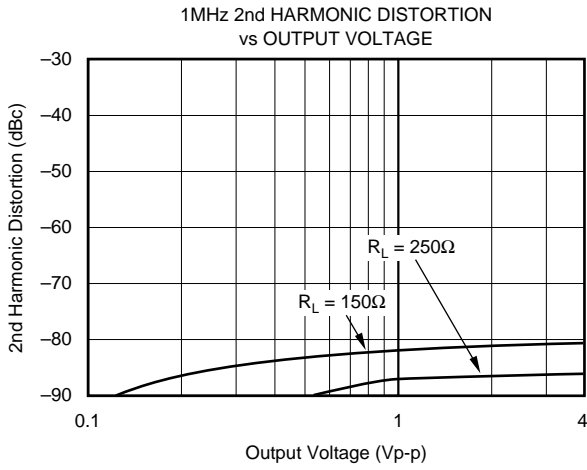

TYPICAL PERFORMANCE CURVES: $V_S = +5V$ (Cont.)

At $T_A = 25^\circ C$, $G = +2$, $R_F = 750\Omega$, and $R_L = 150\Omega$ to $V_S/2$, unless otherwise noted (see Figure 1).

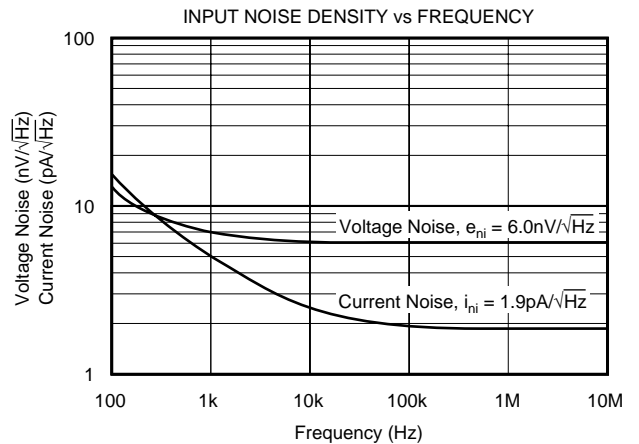
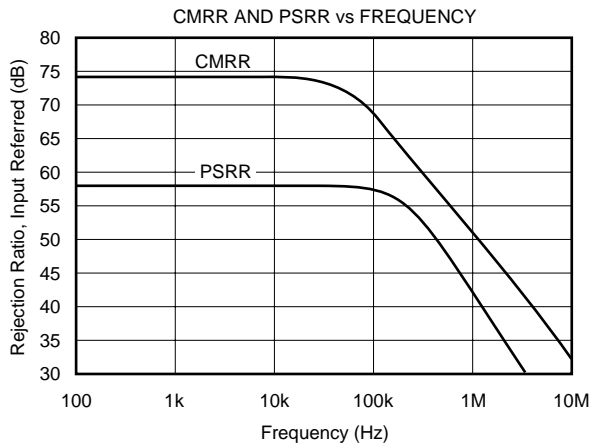
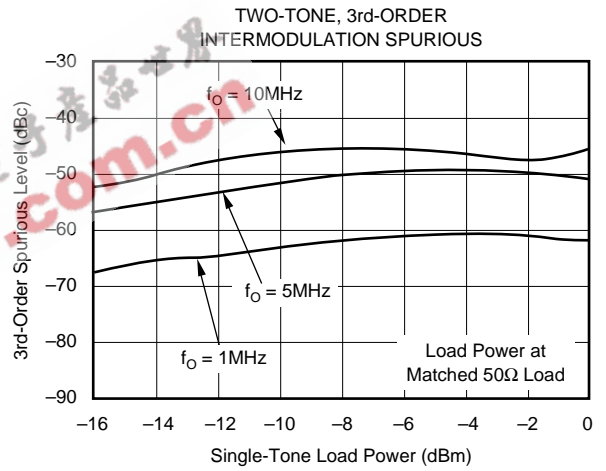
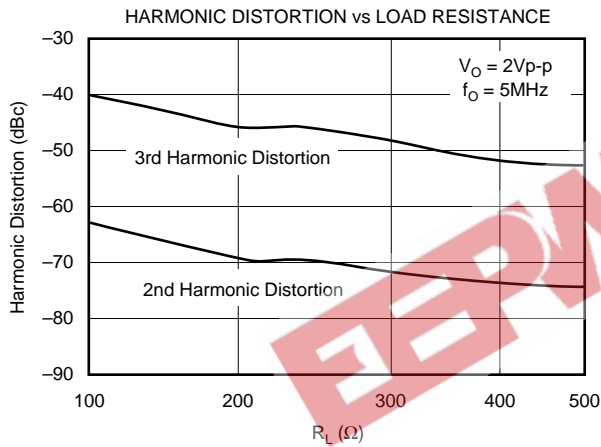
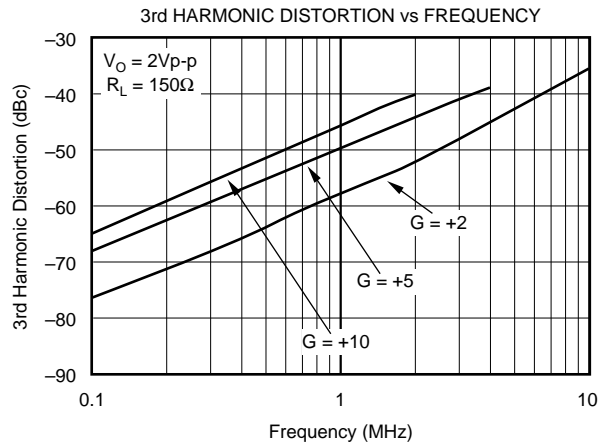
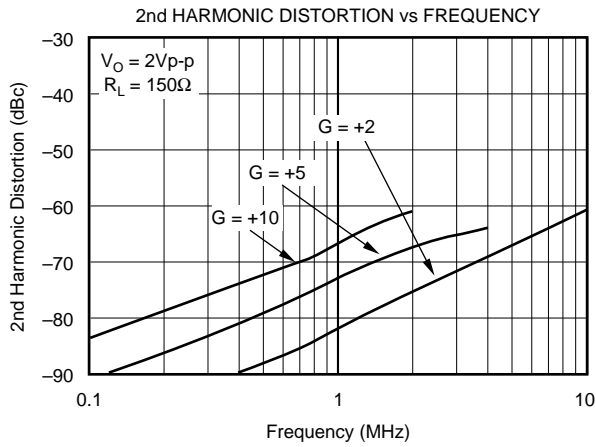

TYPICAL PERFORMANCE CURVES: $V_S = +5V$ (Cont.)

At $T_A = 25^\circ\text{C}$, $G = +2$, $R_F = 750\Omega$, and $R_L = 150\Omega$ to $V_S/2$, unless otherwise noted (see Figure 1).

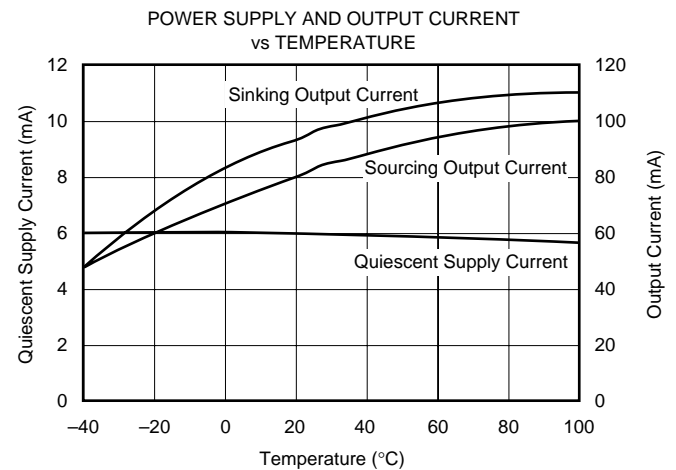
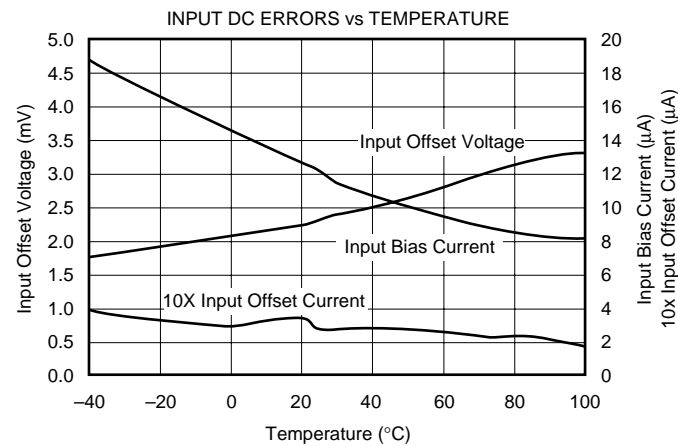
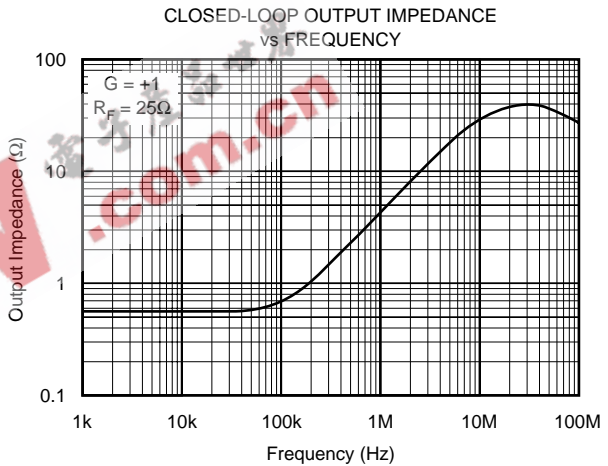
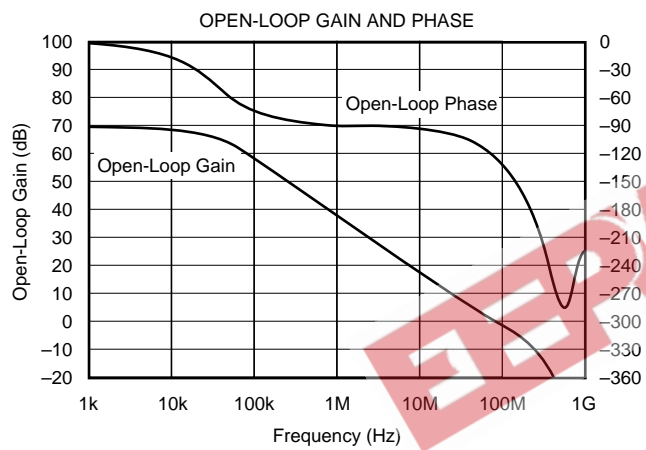
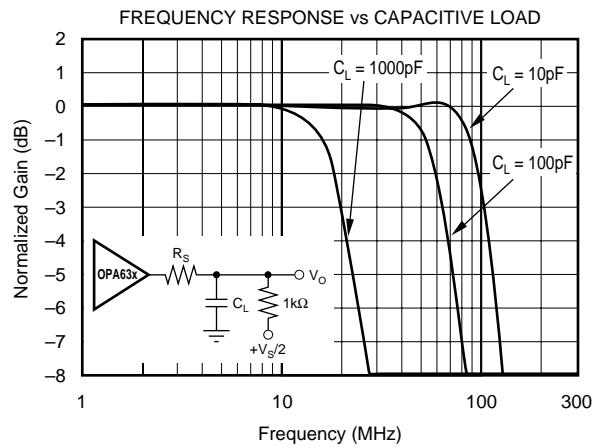
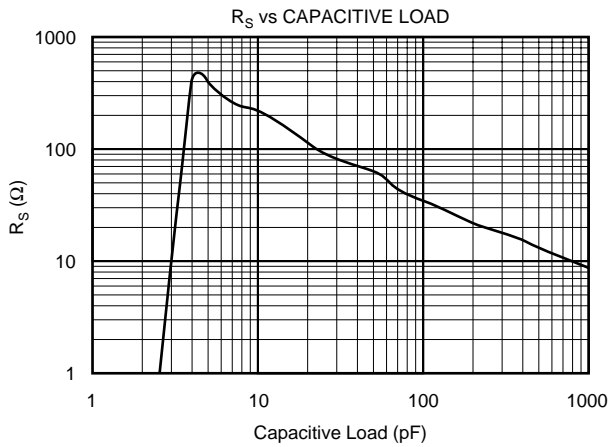

TYPICAL PERFORMANCE CURVES: $V_S = +3V$

At $T_A = 25^\circ\text{C}$, $G = +2$, $R_F = 750\Omega$, and $R_L = 150\Omega$ to $V_S/2$, unless otherwise noted (see Figure 2).

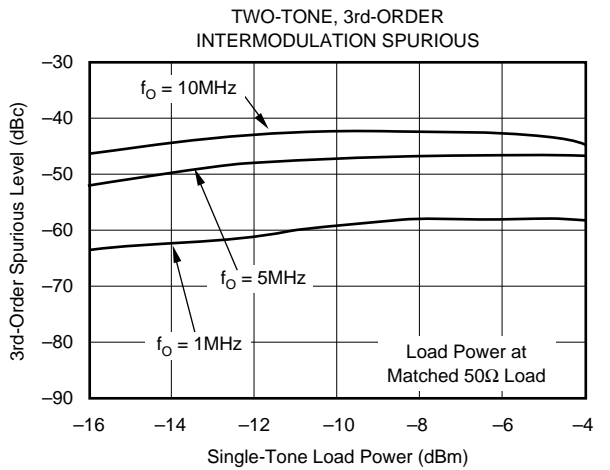
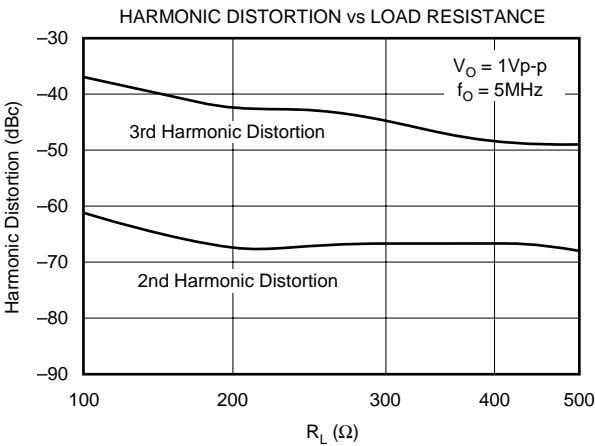
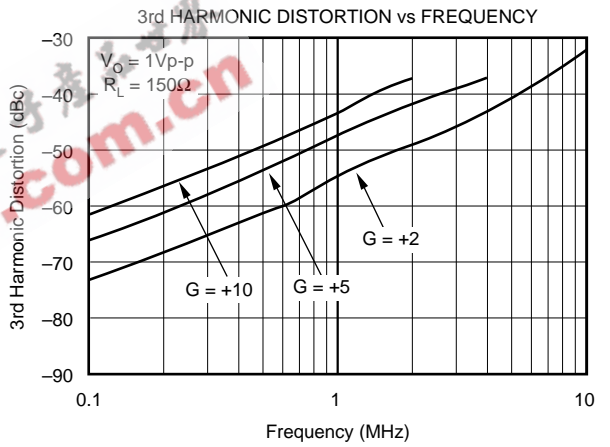
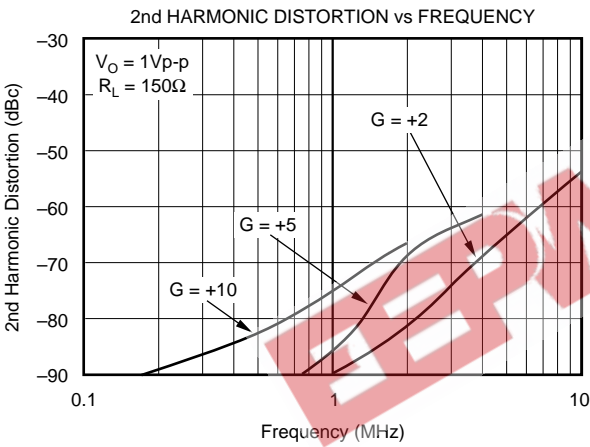
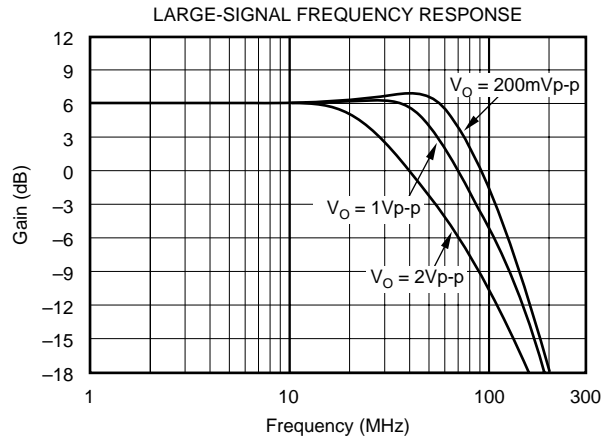
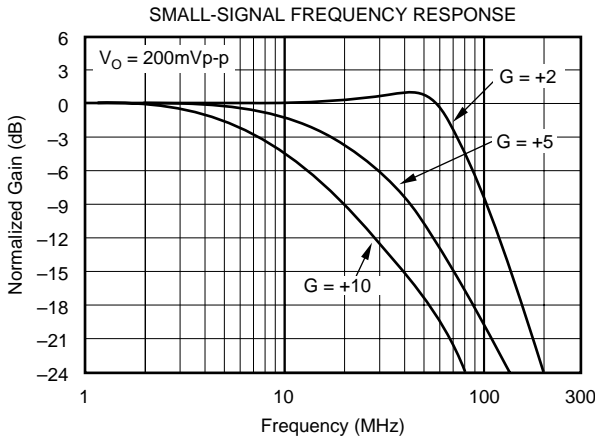

TYPICAL PERFORMANCE CURVES: $V_S = +3V$ (Cont.)

At $T_A = 25^\circ\text{C}$, $G = +2$, $R_F = 750\Omega$, and $R_L = 150\Omega$ to $V_S/2$, unless otherwise noted (see Figure 2).

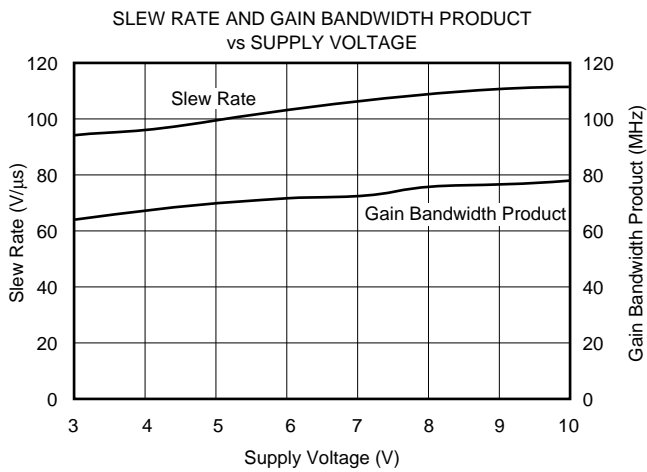
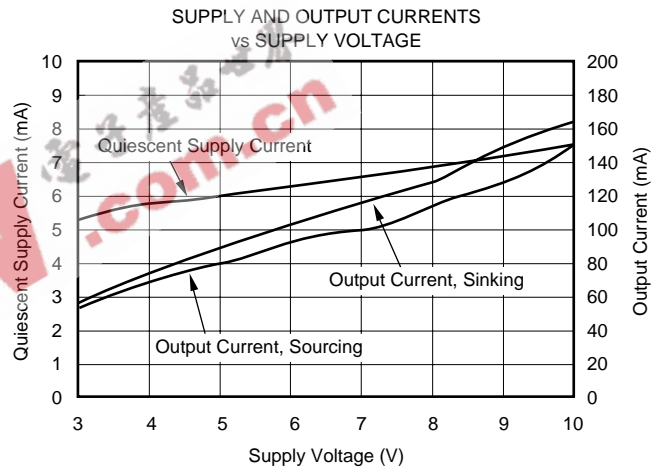
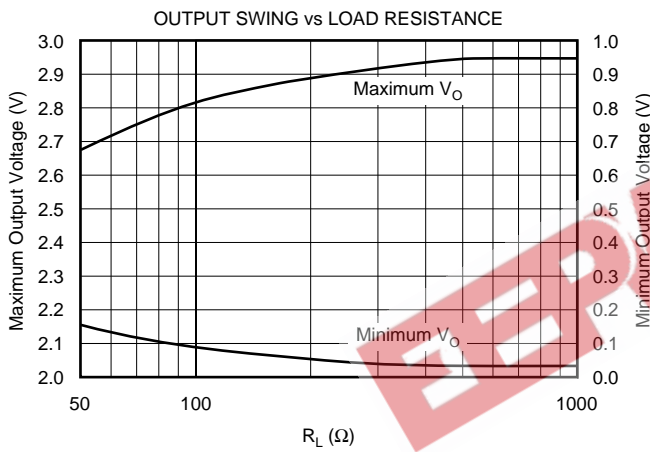
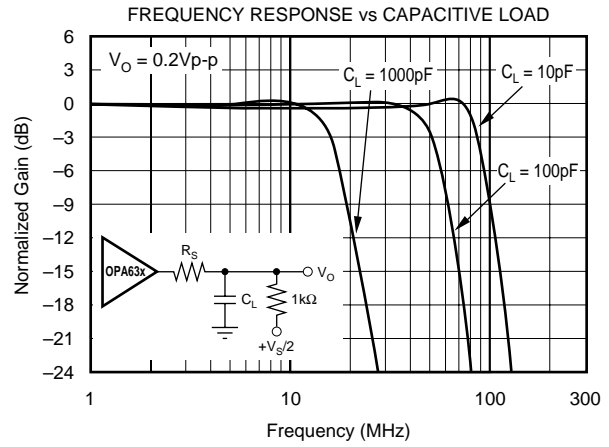
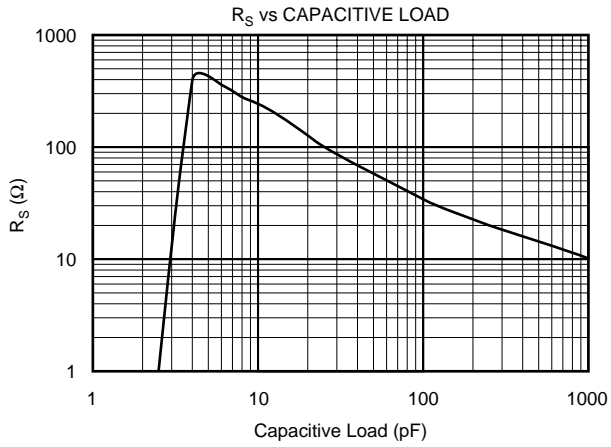

APPLICATIONS INFORMATION

WIDEBAND VOLTAGE-FEEDBACK OPERATION

The OPA631 and OPA632 are unity-gain stable, very high-speed, voltage-feedback op amps designed for single-supply operation (+3V to +5V). The input stage supports input voltages below ground, and within 1.0V of the positive supply. The complementary common-emitter output stage provides an output swing to within 30mV of ground and 130mV of the positive supply. They are compensated to provide stable operation with a wide range of resistive loads. The OPA632's internal disable circuitry is intended to minimize system power when disabled.

Figure 1 shows the AC-coupled, gain of +2 configuration used for the +5V Specifications and Typical Performance Curves. For test purposes, the input impedance is set to 50Ω with a resistor to ground. Voltage swings reported in the Specifications are taken directly at the input and output pins. For the circuit of Figure 1, the total effective load on the output at high frequencies is 150Ω || 1500Ω. The disable pin (OPA635 only) needs to be driven by a low impedance source, such as a CMOS inverter. The 1.50kΩ resistors at the non-inverting input provide the common-mode bias voltage. Their parallel combination equals the DC resistance at the inverting input, minimizing the output DC offset.

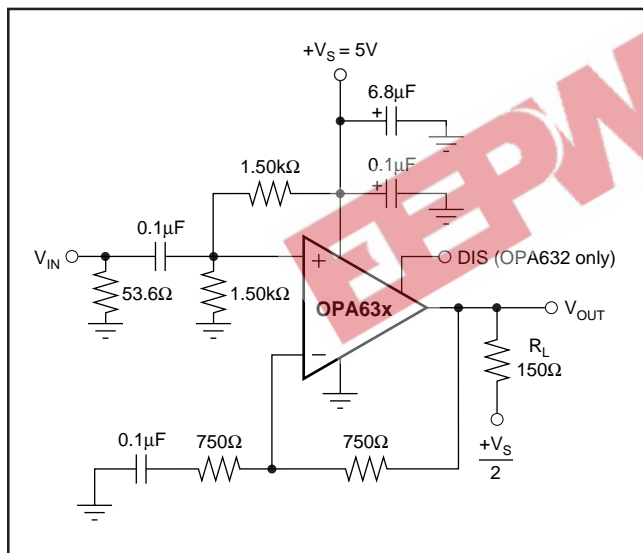

FIGURE 1. AC-Coupled Signal—Resistive Load to Supply Midpoint.

Figure 2 shows the DC-coupled, gain of +2 configuration used for the +3V Specifications and Typical Performance Curves. For test purposes, the input impedance is set to 50Ω with a resistor to ground. Though not strictly a “rail-to-rail” design, these parts come very close, while maintaining excellent performance. They will deliver ≈ 2.9Vp-p on a single +3V supply with 61MHz bandwidth. The 374Ω and 2.26kΩ resistors at the input level-shift V_{IN} so that V_{OUT} is within the allowed output voltage range when $V_{IN} = 0$. See the Typical Performance Curves for information on driving capacitive loads.

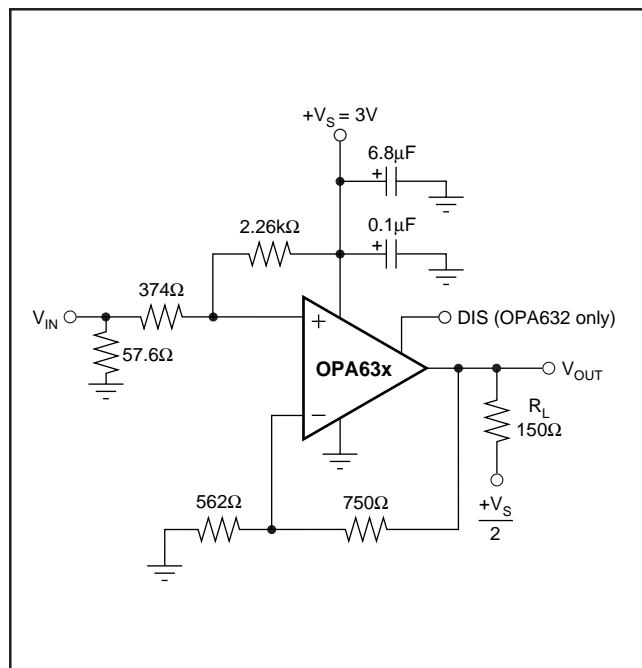

FIGURE 2. DC-Coupled Signal—Resistive Load to Supply Midpoint.

SINGLE-SUPPLY ADC CONVERTER INTERFACE

The front page shows a DC-coupled, single-supply ADC driver circuit. Many systems are now requiring +3V supply capability of both the ADC and its driver. The OPA632 provides excellent performance in this demanding application. Its large input and output voltage ranges, and low distortion, support converters such as the ADS901 shown in this figure. The input level-shifting circuitry was designed so that V_{IN} can be between 0V and 0.5V, while delivering an output voltage of 1V to 2V for the ADS901. Both the OPA632 and ADS901 have power reduction pins with the same polarity for those systems that need to conserve power.

DC LEVEL SHIFTING

Figure 3 shows a DC-coupled non-inverting amplifier that level-shifts the input up to accommodate the desired output voltage range. Given the desired signal gain (G), and the amount V_{OUT} needs to be shifted up (ΔV_{OUT}) when V_{IN} is at the center of its range, the following equations give the resistor values that produce the best DC offset.

$$NG = G + \Delta V_{OUT}/V_S$$

$$R_1 = R_4/G$$

$$R_2 = R_4/(NG - G)$$

$$R_3 = R_4/(NG - 1)$$

where:

$$NG = 1 + R_4/R_3 \text{ (Noise Gain)}$$

$$V_{OUT} = (G)V_{IN} + (NG - G)V_S$$

Make sure that V_{IN} and V_{OUT} stay within the specified input and output voltage ranges.

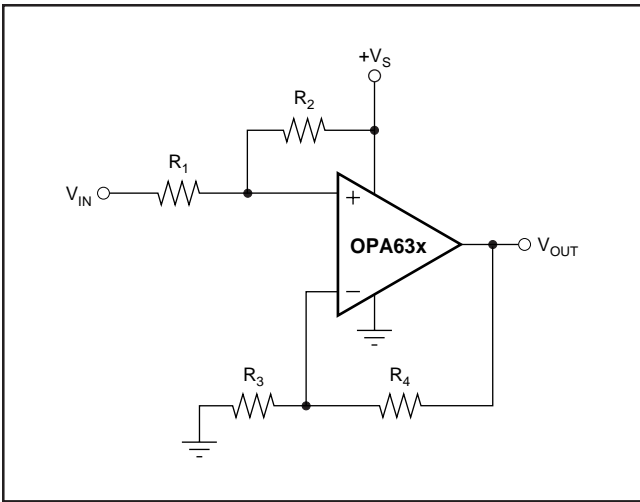

FIGURE 3. DC Level-Shifting Circuit.

The front page circuit is a good example of this type of application. It was designed to take V_{IN} between 0V and 0.5V, and produce V_{OUT} between 1V and 2V, when using a +3V supply. This means $G = 2.00$, and $\Delta V_{OUT} = 1.50V - G \cdot 0.25V = 1.00V$. Plugging into the above equations gives: $NG = 2.33$, $R_1 = 375\Omega$, $R_2 = 2.25k\Omega$, and $R_3 = 563\Omega$. The resistors were changed to the nearest standard values.

NON-INVERTING AMPLIFIER WITH REDUCED PEAKING

Figure 4 shows a non-inverting amplifier that reduces peaking at low gains. The resistor R_C compensates the OPA631 or OPA632 to have higher Noise Gain (NG), which reduces the AC response peaking (typically 5dB at $G = +1$ without R_C) without changing the DC gain. V_{IN} needs to be a low impedance source, such as an op amp. The resistor values are low to reduce noise. Using both R_T and R_F helps minimize the impact of parasitic impedances.

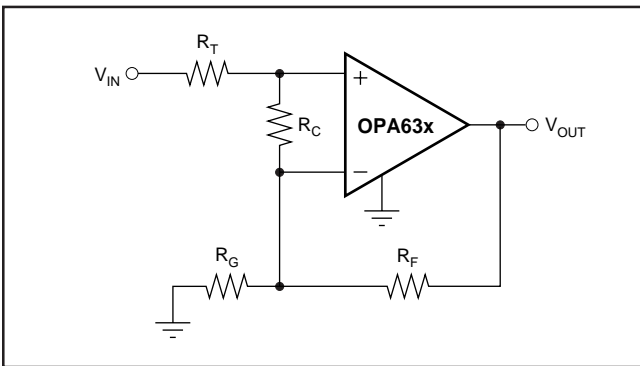

FIGURE 4. Compensated Non-Inverting Amplifier.

The Noise Gain can be calculated as follows:

$$G_1 = 1 + \frac{R_F}{R_G}$$

$$G_2 = 1 + \frac{R_T + R_F / G_1}{R_C}$$

$$NG = G_1 G_2$$

A unity gain buffer can be designed by selecting $R_T = R_F = 20.0\Omega$ and $R_C = 40.2\Omega$ (do not use R_G). This gives a Noise Gain of 2, so its response will be similar to the Characteristics Plots with $G = +2$ which typically gives a flat frequency response, but with less bandwidth.

DESIGN-IN TOOLS

DEMONSTRATION BOARDS

Two PC boards are available to assist in the initial evaluation of circuit performance using the OPA631 and OPA632 in their three package styles. These are available free as an unpopulated PC board delivered with descriptive documentation. The summary information for these boards is shown below:

PRODUCT	PACKAGE	BOARD PART NUMBER	LITERATURE REQUEST NUMBER
OPA63xU	8-Pin SO-8	DEM-OPA68xU	MKT-351
OPA63xN	5-Pin SOT23-5 6-Pin SOT23-6	DEM-OPA6xxN	MKT-348

Contact the Burr-Brown Applications support line to request any of these boards.

OPERATING SUGGESTIONS

OPTIMIZING RESISTOR VALUES

Since the OPA631 and OPA632 are voltage feedback op amps, a wide range of resistor values may be used for the feedback and gain setting resistors. The primary limits on these values are set by dynamic range (noise and distortion) and parasitic capacitance considerations. For a non-inverting unity gain follower application, the feedback connection should be made with a 25Ω resistor, not a direct short (see Figure 4). This will isolate the inverting input capacitance from the output pin and improve the frequency response flatness. Usually, for $G > 1$ application, the feedback resistor value should be between 200Ω and $1.5k\Omega$. Below 200Ω , the feedback network will present additional output loading which can degrade the harmonic distortion performance. Above $1.5k\Omega$, the typical parasitic capacitance (approximately $0.2pF$) across the feedback resistor may cause unintentional band-limiting in the amplifier response.

A good rule of thumb is to target the parallel combination of R_F and R_G (Figure 1) to be less than approximately 400Ω . The combined impedance $R_F \parallel R_G$ interacts with the inverting input capacitance, placing an additional pole in the feedback network and thus, a zero in the forward response. Assuming a $3pF$ total parasitic on the inverting node, holding $R_F \parallel R_G < 400\Omega$ will keep this pole above $130MHz$. By itself, this constraint implies that the feedback resistor R_F can increase to several $k\Omega$ at high gains. This is acceptable as long as the pole formed by R_F and any parasitic capacitance appearing in parallel is kept out of the frequency range of interest.

BANDWIDTH VS GAIN: NON-INVERTING OPERATION

Voltage feedback op amps exhibit decreasing closed-loop bandwidth as the signal gain is increased. In theory, this relationship is described by the Gain Bandwidth Product (GBP) shown in the specifications. Ideally, dividing GBP by the non-inverting signal gain (also called the Noise Gain, or NG) will predict the closed-loop bandwidth. In practice, this only holds true when the phase margin approaches 90° , as it does in high gain configurations. At low gains (increased feedback factors), most amplifiers will exhibit a more complex response with lower phase margin. The OPA631 and OPA632 are compensated to give a slightly peaked response in a non-inverting gain of 2 (Figure 1). This results in a typical gain of +2 bandwidth of 75MHz, far exceeding that predicted by dividing the 68MHz GBP by 2. Increasing the gain will cause the phase margin to approach 90° and the bandwidth to more closely approach the predicted value of (GBP/NG). At a gain of +10, the 7.6MHz bandwidth shown in the Typical Specifications is close to that predicted using the simple formula and the typical GBP.

The OPA631 and OPA632 exhibit minimal bandwidth reduction going to +3V single supply operation as compared with +5V supply. This is because the internal bias control circuitry retains nearly constant quiescent current as the total supply voltage between the supply pins is changed.

INVERTING AMPLIFIER OPERATION

Since the OPA631 and OPA632 are general purpose, wideband voltage feedback op amps, all of the familiar op amp application circuits are available to the designer. Figure 5 shows a typical inverting configuration where the I/O impedances and signal gain from Figure 1 are retained in an inverting circuit configuration. Inverting operation is one of the more common requirements and offers several performance benefits. The inverting configuration shows improved slew rate and distortion. It also allows the input to be biased at $V_S/2$ without any headroom issues. The output voltage can be independently moved to be within the output voltage range with coupling capacitors, or bias adjustment resistors.

In the inverting configuration, three key design consideration must be noted. The first is that the gain resistor (R_G) becomes part of the signal channel input impedance. If input impedance matching is desired (which is beneficial whenever the signal is coupled through a cable, twisted pair, long PC board trace or other transmission line conductor), R_G may be set equal to the required termination value and R_F adjusted to give the desired gain. This is the simplest approach and results in optimum bandwidth and noise performance. However, at low inverting gains, the resultant feedback resistor value can present a significant load to the amplifier output. For an inverting gain of 2, setting R_G to 50Ω for input matching eliminates the need for R_M but requires a 100Ω feedback resistor. This has the interesting advantage that the noise gain becomes equal to 2 for a 50Ω source impedance—the same as the non-inverting circuits considered above. However, the amplifier output will now see the 100Ω feedback resistor in parallel with the external

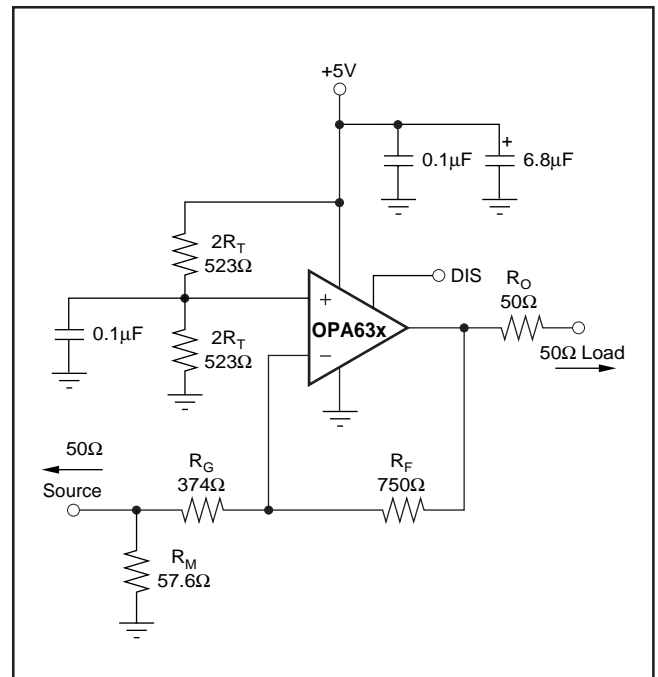

FIGURE 5. Gain of -2 Example Circuit.

load. In general, the feedback resistor should be limited to the 200Ω to $1.5k\Omega$ range. In this case, it is preferable to increase both the R_F and R_G values as shown in Figure 5, and then achieve the input matching impedance with a third resistor (R_M) to ground. The total input impedance becomes the parallel combination of R_G and R_M .

The second major consideration, touched on in the previous paragraph, is that the signal source impedance becomes part of the noise gain equation and hence influences the bandwidth. For the example in Figure 5, the R_M value combines in parallel with the external 50Ω source impedance, yielding an effective driving impedance of $50\Omega \parallel 576\Omega = 26.8\Omega$. This impedance is added in series with R_G for calculating the noise gain. The resultant is 2.87 for Figure 5, as opposed to only 2 if R_M could be eliminated as discussed above. The bandwidth will therefore be lower for the gain of -2 circuit of Figure 5 (NG = +3) than for the gain of +2 circuit of Figure 1.

The third important consideration in inverting amplifier design is setting the bias current cancellation resistors on the non-inverting input (a parallel combination of $R_T = 263\Omega$). If this resistor is set equal to the total DC resistance looking out of the inverting node, the output DC error, due to the input bias currents, will be reduced to (Input Offset Current) $\cdot R_F$. If the 50Ω source impedance is DC-coupled in Figure 5, the total resistance to ground between the inverting input and the source will be 401Ω . Combining this in parallel with the feedback resistor gives the $R_T = 263\Omega$ used in this example. To reduce the additional high frequency noise introduced by this resistor, and power supply feedthrough, R_T is bypassed with a capacitor. As long as $R_T < 400\Omega$, its noise contribution will be minimal. As a minimum, the OPA631 and OPA632 require an R_T

value of 50Ω to damp out parasitic-induced peaking—a direct short to ground on the non-inverting input runs the risk of a very high frequency instability in the input stage.

OUTPUT CURRENT AND VOLTAGE

The OPA631 and OPA632 provide outstanding output voltage capability. Under no-load conditions at $+25^\circ\text{C}$, the output voltage typically swings closer than 130mV to either supply rail; the guaranteed swing limit is within 400mV of either rail ($V_S = +5\text{V}$).

The minimum specified output voltage and current specifications over temperature are set by worst-case simulations at the cold temperature extreme. Only at cold start-up will the output current and voltage decrease to the numbers shown in the guaranteed tables. As the output transistors deliver power, their junction temperatures will increase, decreasing their V_{BE} 's (increasing the available output voltage swing) and increasing their current gains (increasing the available output current). In steady-state operation, the available output voltage and current will always be greater than that shown in the over-temperature specifications since the output stage junction temperatures will be higher than the minimum specified operating ambient.

To maintain maximum output stage linearity, no output short-circuit protection is provided. This will not normally be a problem since most applications include a series matching resistor at the output that will limit the internal power dissipation if the output side of this resistor is shorted to ground.

DRIVING CAPACITIVE LOADS

One of the most demanding and yet very common load conditions for an op amp is capacitive loading. Often, the capacitive load is the input of an A/D converter—including additional external capacitance which may be recommended to improve A/D linearity. A high speed, high open-loop gain amplifier like the OPA631 and OPA632 can be very susceptible to decreased stability and closed-loop response peaking when a capacitive load is placed directly on the output pin. When the primary considerations are frequency response flatness, pulse response fidelity and/or distortion, the simplest and most effective solution is to isolate the capacitive load from the feedback loop by inserting a series isolation resistor between the amplifier output and the capacitive load.

The Typical Performance Curves show the recommended R_S versus capacitive load and the resulting frequency response at the load. Parasitic capacitive loads greater than 2pF can begin to degrade the performance of the OPA631 and OPA632. Long PC board traces, unmatched cables, and connections to multiple devices can easily exceed this value. Always consider this effect carefully, and add the recommended series resistor as close as possible to the output pin (see Board Layout Guidelines).

The criterion for setting this R_S resistor is a maximum bandwidth, flat frequency response at the load. For a gain of $+2$, the frequency response at the output pin is already slightly peaked without the capacitive load, requiring relatively high values of R_S to flatten the response at the load. Increasing the noise gain will also reduce the peaking (see Figure 4).

DISTORTION PERFORMANCE

The OPA631 and OPA632 provide good distortion performance into a 150Ω load. Relative to alternative solutions, it provides exceptional performance into lighter loads and/or operating on a single $+3\text{V}$ supply. Generally, the 3rd harmonic will dominate the distortion. Focusing then on the 3rd harmonic, increasing the load impedance improves distortion directly. Remember that the total load includes the feedback network; in the non-inverting configuration (Figure 1) this is sum of $R_F + R_G$, while in the inverting configuration, it is just R_F .

NOISE PERFORMANCE

High slew rate, unity gain stable, voltage feedback op amps usually achieve their slew rate at the expense of a higher input noise voltage. The $6.0\text{nV}/\sqrt{\text{Hz}}$ input voltage noise for the OPA631 and OPA632 is, however, much lower than comparable amplifiers. The input-referred voltage noise, and the two input-referred current noise terms ($1.9\text{pA}/\sqrt{\text{Hz}}$), combine to give low output noise under a wide variety of operating conditions. Figure 6 shows the op amp noise analysis model with all the noise terms included. In this model, all noise terms are taken to be noise voltage or current density terms in either $\text{nV}/\sqrt{\text{Hz}}$ or $\text{pA}/\sqrt{\text{Hz}}$.

The total output spot noise voltage can be computed as the square root of the sum of all squared output noise voltage contributors. Equation 1 shows the general form for the output noise voltage using the terms shown in Figure 6.

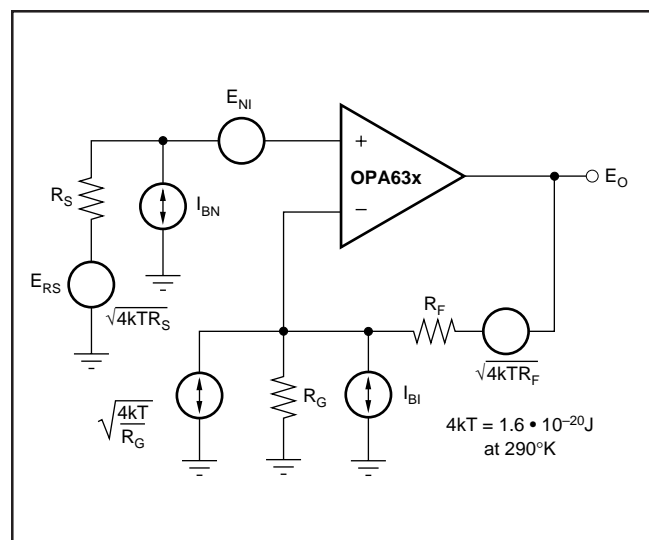

FIGURE 6. Noise Analysis Model.

Equation 1:

$$E_O = \sqrt{\left(E_{NI}^2 + (I_{BN}R_S)^2 + 4kTR_S\right)NG^2 + (I_{BI}R_F)^2 + 4kTR_F}NG$$

Dividing this expression by the noise gain ($NG = (1+R_F/R_G)$) will give the equivalent input-referred spot noise voltage at the non-inverting input, as shown in Equation 2.

Equation 2:

$$E_N = \sqrt{E_{NI}^2 + (I_{BN}R_S)^2 + 4kTR_S + \left(\frac{I_{BI}R_F}{NG}\right)^2 + \frac{4kTR_F}{NG}}$$

Evaluating these two equations for the circuit and component values shown in Figure 1 will give a total output spot noise voltage of $13.1nV/\sqrt{Hz}$ and a total equivalent input spot noise voltage of $6.6nV/\sqrt{Hz}$. This is including the noise added by the resistors. This total input-referred spot noise voltage is not much higher than the $6.0nV/\sqrt{Hz}$ specification for the op amp voltage noise alone. This will be the case as long as the impedances appearing at each op amp input are limited to the previously recommend maximum value of 400Ω , and the input attenuation is low. Since the resistor-induced noise is relatively negligible, additional capacitive decoupling across the bias current cancellation resistor (R_T) for the inverting op amp configuration of Figure 5 is not required.

DC ACCURACY AND OFFSET CONTROL

The balanced input stage of a wideband voltage feedback op amp allows good output DC accuracy in a wide variety of applications. The power supply current trim for the OPA631 and OPA632 gives even tighter control than comparable products. Although the high-speed input stage does require relatively high input bias current (typically $1\mu A$ out of each input terminal), the close matching between them may be used to reduce the output DC error caused by this current. This is done by matching the DC source resistances appearing at the two inputs. Evaluating the configuration of Figure 1 (which has matched DC input resistances), using worst-case $+25^\circ C$ input offset voltage and current specifications, gives a worst-case output offset voltage equal to: ($NG =$ non-inverting signal gain at DC)

$$\begin{aligned} & \pm(NG \cdot V_{OS(MAX)}) \pm (R_F \cdot I_{OS(MAX)}) \\ & = \pm(1 \cdot 6.0mV) \pm (750\Omega \cdot 2.0\mu A) \\ & = \pm 6.8mV = \text{Output Offset Range for Figure 1} \end{aligned}$$

A fine scale output offset null, or DC operating point adjustment, is often required. Numerous techniques are available for introducing DC offset control into an op amp circuit. Most of these techniques are based on adding a DC current through the feedback resistor. In selecting an offset trim method, one key consideration is the impact on the desired signal path frequency response. If the signal path is intended to be non-inverting, the offset control is best applied as an inverting summing signal to avoid interaction with the signal source. If the signal path is intended to be

inverting, applying the offset control to the non-inverting input may be considered. Bring the DC offsetting current into the inverting input node through resistor values that are much larger than the signal path resistors. This will insure that the adjustment circuit has minimal effect on the loop gain and hence the frequency response.

DISABLE OPERATION

The OPA632 provides an optional disable feature that may be used either to reduce system power or to implement a simple channel multiplexing operation. To disable, the control pin must be asserted HIGH. Figure 7 shows a simplified internal circuit for the disable control feature.

In normal operation, base current to Q1 is provided through the DIS pin and the $50k\Omega$ resistor.

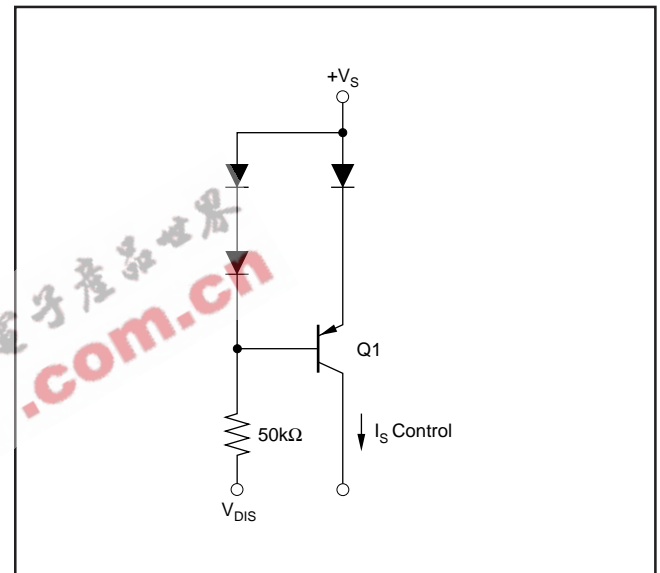

FIGURE 7. Simplified Disable Control Circuit (OPA632).

One key parameter in disable operation is the output glitch when switching in and out of the disabled mode.

The transition edge rate (dv/dt) of the DIS control line will influence this glitch. Adding a simple RC filter into the DIS pin from a higher speed logic line will reduce the glitch. If extremely fast transition logic is used, a $1k\Omega$ series resistor will provide adequate band limiting using just the parasitic input capacitance on the DIS pin while still ensuring adequate logic level swing.

THERMAL ANALYSIS

Maximum desired junction temperature will set the maximum allowed internal power dissipation as described below. In no case should the maximum junction temperature be allowed to exceed $175^\circ C$.

Operating junction temperature (T_J) is given by $T_A + P_D \cdot \theta_{JA}$. The total internal power dissipation (P_D) is the sum of quiescent power (P_{DQ}) and additional power dissipated in the output stage (P_{DL}) to deliver load power. Quiescent power is

simply the specified no-load supply current times the total supply voltage across the part. P_{DL} will depend on the required output signal and load but would, for resistive load connected to mid-supply ($V_S/2$), be at a maximum when the output is fixed at a voltage equal to $V_S/4$ or $3V_S/4$. Under this condition, $P_{DL} = V_S^2/(16 \cdot R_L)$, where R_L includes feedback network loading.

Note that it is the power in the output stage and not into the load that determines internal power dissipation.

As a worst-case example, compute the maximum T_J using an OPA632 (SOT23-6 package) in the circuit of Figure 1 operating at the maximum specified ambient temperature of +85°C and driving a 150Ω load at mid-supply.

$$P_D = 10V \cdot 6.9mA + 5^2/(16 \cdot (150\Omega \parallel 1500\Omega)) = 80mW$$

$$\text{Maximum } T_J = +85^\circ\text{C} + (0.08W \cdot 150^\circ\text{C/W}) = 97^\circ\text{C}.$$

Although this is still well below the specified maximum junction temperature, system reliability considerations may require lower guaranteed junction temperatures. The highest possible internal dissipation will occur if the load requires current to be forced into the output at high output voltages or sourced from the output at low output voltages. This puts a high current through a large internal voltage drop in the output transistors.

BOARD LAYOUT GUIDELINES

Achieving optimum performance with a high frequency amplifier like the OPA631 and OPA632 requires careful attention to board layout parasitics and external component types. Recommendations that will optimize performance include:

a) Minimize parasitic capacitance to any AC ground for all of the signal I/O pins. Parasitic capacitance on the output and inverting input pins can cause instability: on the non-inverting input, it can react with the source impedance to cause unintentional bandlimiting. To reduce unwanted capacitance, a window around the signal I/O pins should be opened in all of the ground and power planes around those pins. Otherwise, ground and power planes should be unbroken elsewhere on the board.

b) Minimize the distance (<0.25") from the power supply pins to high frequency 0.1μF decoupling capacitors. At the device pins, the ground and power plane layout should not be in close proximity to the signal I/O pins. Avoid narrow power and ground traces to minimize inductance between the pins and the decoupling capacitors. The power supply connections should always be decoupled with these capacitors. An optional supply decoupling capacitor (0.1μF) across the two power supplies (for bipolar operation) will improve 2nd harmonic distortion performance. Larger (2.2μF to 6.8μF) decoupling capacitors, effective at lower frequency, should also be used on the main supply pins. These may be placed somewhat farther from the device and may be shared among several devices in the same area of the PC board.

c) Careful selection and placement of external components will preserve the high frequency performance.

Resistors should be a very low reactance type. Surface-mount resistors work best and allow a tighter overall layout. Metal film or carbon composition axially-leaded resistors can also provide good high frequency performance. Again, keep their leads and PC board traces as short as possible. Never use wirewound type resistors in a high frequency application. Since the output pin and inverting input pin are the most sensitive to parasitic capacitance, always position the feedback and series output resistor, if any, as close as possible to the output pin. Other network components, such as non-inverting input termination resistors, should also be placed close to the package. Where double-side component mounting is allowed, place the feedback resistor directly under the package on the other side of the board between the output and inverting input pins. Even with a low parasitic capacitance shunting the external resistors, excessively high resistor values can create significant time constants that can degrade performance. Good axial metal film or surface-mount resistors have approximately 0.2pF in shunt with the resistor. For resistor values > 1.5kΩ, this parasitic capacitance can add a pole and/or zero below 500MHz that can effect circuit operation. Keep resistor values as low as possible consistent with load driving considerations. The 750Ω feedback used in the typical performance specifications is a good starting point for design. See Figure 4 for the unity gain follower application.

d) Connections to other wideband devices on the board may be made with short direct traces or through on-board transmission lines. For short connections, consider the trace and the input to the next device as a lumped capacitive load. Relatively wide traces (50mils to 100mils) should be used, preferably with ground and power planes opened up around them. Estimate the total capacitive load and set R_S from the plot of Recommended R_S vs Capacitive Load. Low parasitic capacitive loads (< 5pF) may not need an R_S since the OPA631 and OPA632 are nominally compensated to operate with a 2pF parasitic load. Higher parasitic capacitive loads without an R_S are allowed as the signal gain increases (increasing the unloaded phase margin) If a long trace is required, and the 6dB signal loss intrinsic to a doubly terminated transmission line is acceptable, implement a matched impedance transmission line using microstrip or stripline techniques (consult an ECL design handbook for microstrip and stripline layout techniques). A 50Ω environment is normally not necessary on board, and in fact, a higher impedance environment will improve distortion as shown in the distortion versus load plots. With a characteristic board trace impedance defined (based on board material and trace dimensions), a matching series resistor into the trace from the output of the OPA631 and OPA632 is used as well as a terminating shunt resistor at the input of the destination device. Remember also that the terminating impedance will be the parallel combination of the shunt resistor and the input impedance of the destination device; this total effective impedance should be set to match the trace impedance. If the 6dB attenuation of a doubly termi-

nated transmission line is unacceptable, a long trace can be series-terminated at the source end only. Treat the trace as a capacitive load in this case and set the series resistor value as shown in the plot of Recommended R_S vs Capacitive Load. This will not preserve signal integrity as well as a doubly terminated line. If the input impedance of the destination device is low, there will be some signal attenuation due to the voltage divider formed by the series output into the terminating impedance.

e) **Socketing a high speed part is not recommended.** The additional lead length and pin-to-pin capacitance introduced by the socket can create an extremely troublesome parasitic network which can make it almost impossible to achieve a smooth, stable frequency response. Best results are obtained by soldering the OPA631 and OPA632 onto the board.

INPUT AND ESD PROTECTION

The OPA631 and OPA632 are built using a very high speed complementary bipolar process. The internal junction breakdown voltages are relatively low for these very small geometry devices. These breakdowns are reflected in the Absolute Maximum Ratings table. All device pins are protected with internal ESD protection diodes to the power supplies as shown in Figure 8.

These diodes provide moderate protection to input overdrive voltages above the supplies as well. The protection diodes can typically support 30mA continuous current. Where higher currents are possible (e.g., in systems with $\pm 15V$ supply parts driving into the OPA631 and OPA632), current-limiting series resistors should be added into the two inputs. Keep these resistor values as low as possible since high values degrade both noise performance and frequency response.

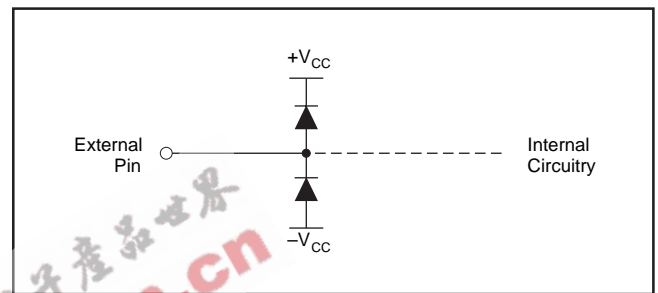

FIGURE 8. Internal ESD Protection.