



**OPA512**

## Very-High Current—High Power OPERATIONAL AMPLIFIER

### FEATURES

- WIDE SUPPLY RANGE:  $\pm 10V$  to  $\pm 50V$
- HIGH OUTPUT CURRENT: 15A Peak
- CLASS A/B OUTPUT STAGE:  
Low Distortion
- VOLTAGE-CURRENT LIMIT PROTECTION  
CIRCUIT
- SMALL TO-3 PACKAGE

### APPLICATIONS

- SERVO AMPLIFIER
- MOTOR DRIVER
- SYNCRO EXCITATION
- AUDIO AMPLIFIER
- TEST PIN DRIVER

### DESCRIPTION

The OPA512 is a high voltage, very-high current operational amplifier designed to drive a wide variety of resistive and reactive loads. Its complementary class A/B output stage provides superior performance in applications requiring freedom from cross-over distortion. User-set current limit circuitry provides protection to the amplifier and load in fault conditions. A resistor-programmable voltage-current limiter circuit may be used to further protect the amplifier from damaging conditions.

The OPA512 employs a laser-trimmed monolithic integrated circuit to bias the output transistors, providing excellent low-level signal fidelity and high output voltage swing. The reduced internal parts count made possible with this monolithic IC improves performance and reliability.

This hybrid integrated circuit is housed in a hermetic TO-3 package and all circuitry is electrically-isolated from the case. This allows direct mounting to a chassis or heat sink without cumbersome insulating hardware and provides optimum heat transfer.

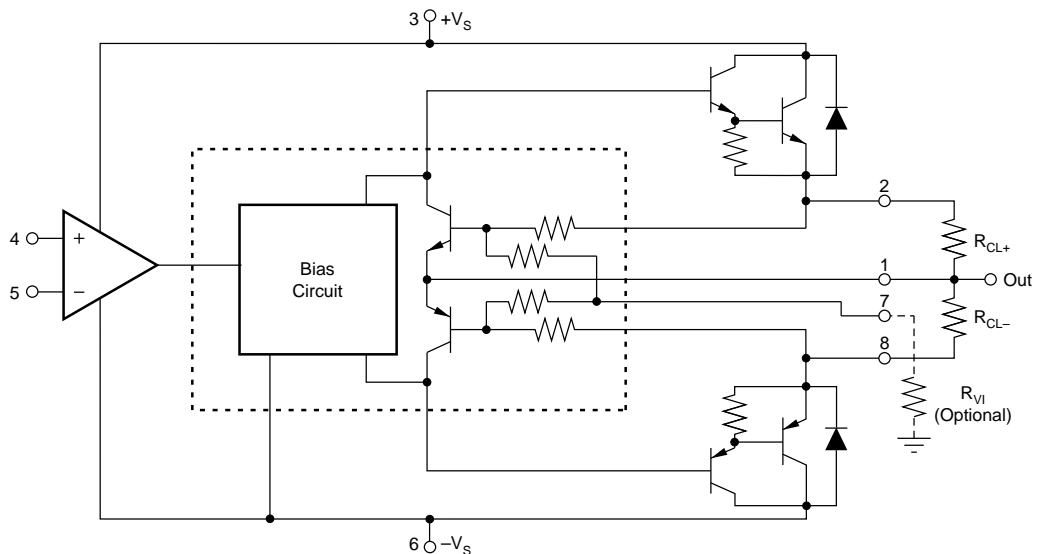

International Airport Industrial Park • Mailing Address: PO Box 11400 • Tucson, AZ 85734 • Street Address: 6730 S. Tucson Blvd. • Tucson, AZ 85706  
Tel: (520) 746-1111 • Twx: 910-952-1111 • Cable: BBRCORP • Telex: 066-6491 • FAX: (520) 889-1510 • Immediate Product Info: (800) 548-6132

# SPECIFICATIONS

## ELECTRICAL

At  $T_C = +25^\circ\text{C}$ , and  $V_S = \pm 40\text{V}$ , unless otherwise noted.

PARAMETER	CONDITIONS	OPA512BM			OPA512SM			UNITS
		MIN	TYP	MAX	MIN	TYP	MAX	
<b>INPUT OFFSET VOLTAGE</b> Initial Offset vs Temperature vs Supply Voltage vs Power	Specified Temp. Range		$\pm 2$ $\pm 10$ $\pm 30$ $\pm 20$	$\pm 6$ $\pm 65$ $\pm 200$		$\pm 1$ * * *	$\pm 3$ $\pm 40$ *	mV $\mu\text{V}/^\circ\text{C}$ $\mu\text{V}/\text{V}$ $\mu\text{V}/\text{V}$
<b>INPUT BIAS CURRENT</b> Initial vs Temperature vs Supply Voltage	Specified Temp. Range		12 $\pm 50$ $\pm 10$	30 400		10 * *	20 *	nA $\text{pA}/^\circ\text{C}$ $\text{pA}/\text{V}$
<b>INPUT OFFSET CURRENT</b> Initial vs Temperature	Specified Temp. Range		$\pm 12$ $\pm 50$	$\pm 30$		$\pm 5$ *	$\pm 10$	nA $\text{pA}/^\circ\text{C}$
<b>INPUT IMPEDANCE, DC</b>			200			*		$\text{M}\Omega$
<b>INPUT CAPACITANCE</b>			3			*		pF
<b>VOLTAGE RANGE</b> Common-Mode Voltage Common-Mode Rejection	Specified Temp. Range Specified Temp. Range	$\pm( V_S  - 5)$ 74	$\pm( V_S  - 3)$ 100		* *	* *		V dB
<b>GAIN</b> Open-Loop Gain at 10Hz  Gain-Bandwidth Product, 1MHz Power Bandwidth Phase Margin	1k $\Omega$ Load Specified Temp. Range 8 $\Omega$ Load 8 $\Omega$ Load 8 $\Omega$ Load Specified Temp. Range 8 $\Omega$ Load		110 96 108 4 20 20			* * * *		dB dB MHz kHz Degrees
<b>OUTPUT</b> Voltage Swing <sup>(1)</sup>  Current, Peak Settling Time to 0.1% Slew Rate Capacitive Load	BM at 10A, SM at 15A Specified Temp. Range $I_O = 80\text{mA}$ $I_O = 5\text{A}$ 2V Step Specified Temp. Range G = 1 Specified Temp. Range G > 10	$\pm( V_S  - 6)$ $\pm( V_S  - 5)$ $\pm( V_S  - 5)$ 10			$\pm( V_S  - 7)$ * * 15	* * *		V V V A $\mu\text{s}$ $\text{V}/\mu\text{s}$ nF
<b>POWER SUPPLY</b> Voltage Current, Quiescent	Specified Temp. Range	$\pm 10$	$\pm 40$ 25	$\pm 45$ 50	*	* *	$\pm 50$ 35	V mA
<b>THERMAL RESISTANCE</b> AC Junction-to-Case <sup>(3)</sup>  DC Junction-to-Case Junction to Air	$T_C = -55^\circ\text{C}$ to $+125^\circ\text{C}$ , $f > 60\text{Hz}$ $T_C = -55^\circ\text{C}$ to $+125^\circ\text{C}$ $T_C = -55^\circ\text{C}$ to $+125^\circ\text{C}$		0.8 1.25 30	0.9 1.4		* * *	* *	$^\circ\text{C}/\text{W}$ $^\circ\text{C}/\text{W}$ $^\circ\text{C}/\text{W}$
<b>TEMPERATURE RANGE</b> Specified	$T_C$	-25		+85	-55		+125	$^\circ\text{C}$

\*Specification same as OPA512BM.

NOTES: (1)  $+V_S$  and  $-V_S$  denote the positive and negative supply voltage, respectively. Total  $V_S$  is measured from  $+V_S$  to  $-V_S$ . (2) SOA = Safe Operating Area. (3) Rating applies if the output current alternates between both output transistors at a rate faster than 60Hz.

The information provided herein is believed to be reliable; however, BURR-BROWN assumes no responsibility for inaccuracies or omissions. BURR-BROWN assumes no responsibility for the use of this information, and all use of such information shall be entirely at the user's own risk. Prices and specifications are subject to change without notice. No patent rights or licenses to any of the circuits described herein are implied or granted to any third party. BURR-BROWN does not authorize or warrant any BURR-BROWN product for use in life support devices and/or systems.

## ABSOLUTE MAXIMUM RATINGS

Supply Voltage, $+V_S$ to $-V_S$ .....	100V
Output Current: Source .....	15A
Sink .....	see SOA
Power Dissipation, Internal <sup>(1)</sup> .....	125W
Input Voltage: Differential .....	$\pm( V_S  - 3V)$
Common-mode .....	$\pm V_S$
Temperature: Pins (soldering, 10s) .....	+300°C
Junction <sup>(1)</sup> .....	+200°C
Temperature Range: Storage <sup>(2)</sup> .....	-65°C to +150°C
Operating (Case) .....	-55°C to +125°C

NOTES: (1) Long term operation at the maximum junction temperature will result in reduced product life. Derate internal power dissipation to achieve high MTTF. (2) OPA512BM, -55°C to +100°C.

## CONNECTION DIAGRAM

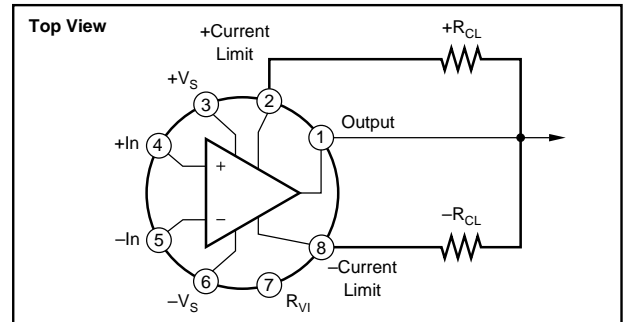

## ORDERING INFORMATION

MODEL	PACKAGE	TEMPERATURE RANGE
OPA512BM	8-pin TO-3	-25°C to +85°C
OPA512SM	8-pin TO-3	-55°C to +125°C

## PACKAGE INFORMATION

MODEL	PACKAGE	PACKAGE DRAWING NUMBER <sup>(1)</sup>
OPA512BM	8-Pin TO-3	030
OPA512SM	8-Pin TO-3	030

NOTE: (1) For detailed drawing and dimension table, please see end of data sheet, or Appendix D of Burr-Brown IC Data Book.

EEPW 电子产品世界 .com.cn

# TYPICAL PERFORMANCE CURVES

$T_A = 25^\circ\text{C}$ ,  $V_S = \pm 40\text{VDC}$ , unless otherwise noted.

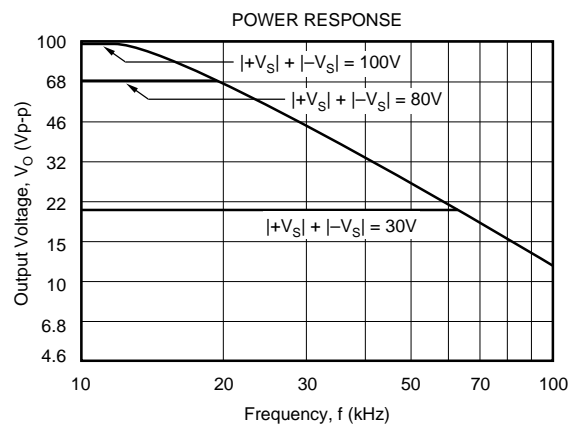
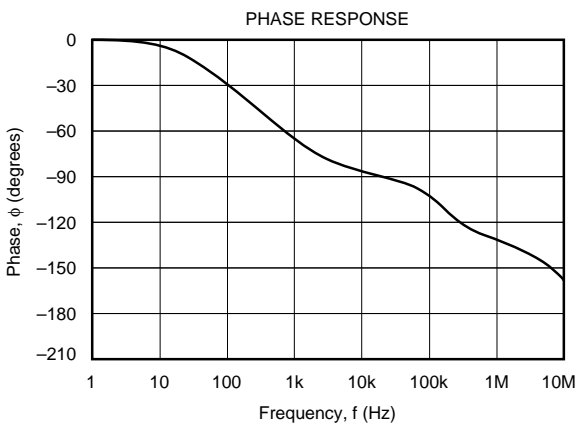
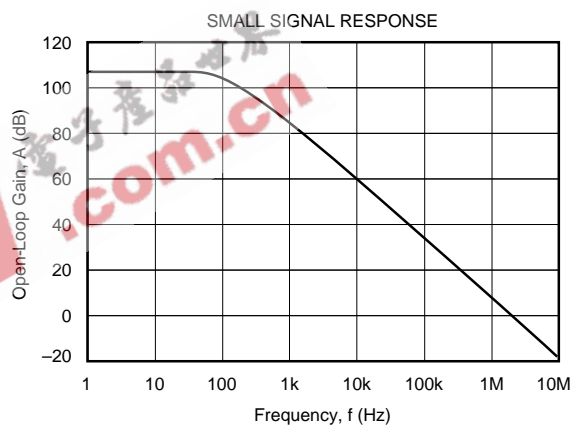
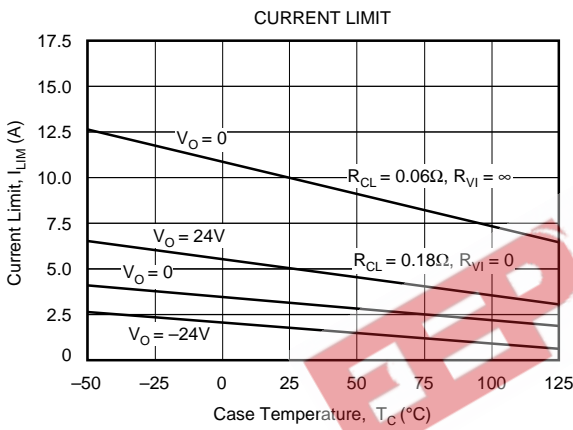
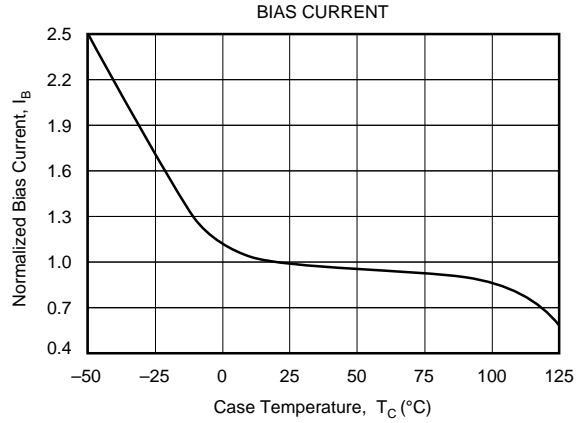
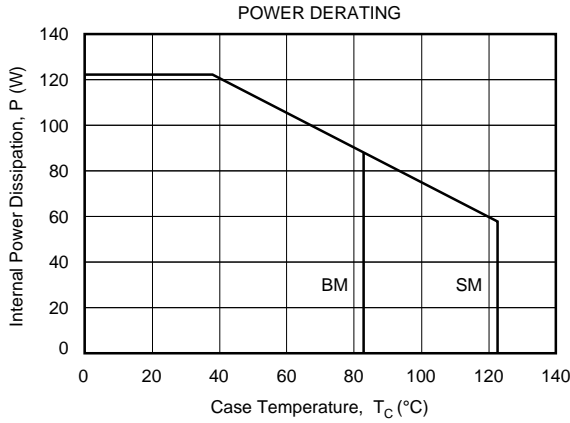

# TYPICAL PERFORMANCE CURVES (CONT)

$T_A = 25^\circ\text{C}$ ,  $V_S = \pm 40\text{VDC}$ , unless otherwise noted.

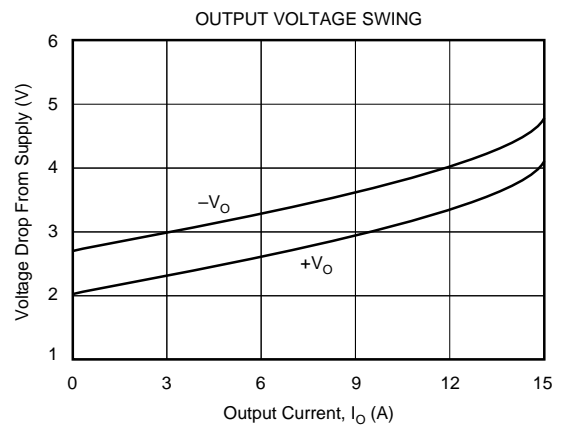
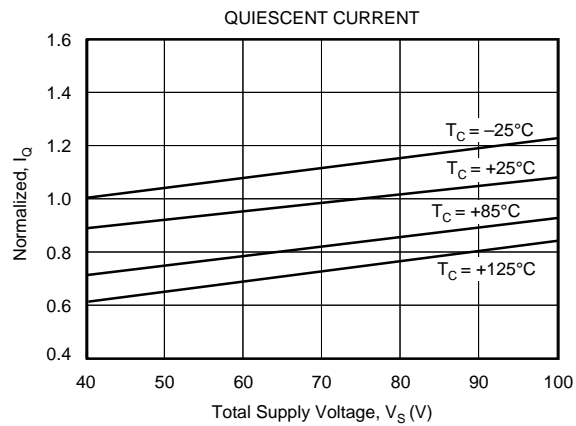
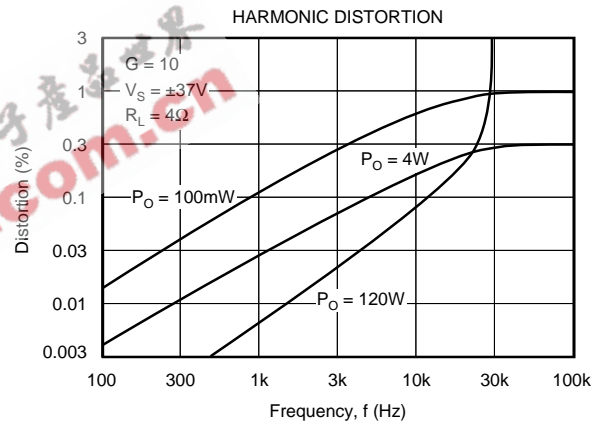
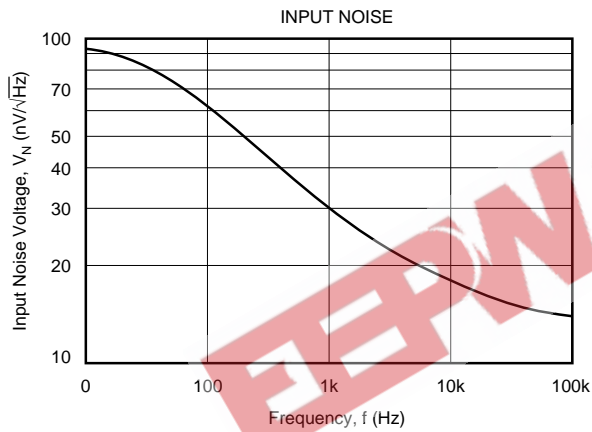
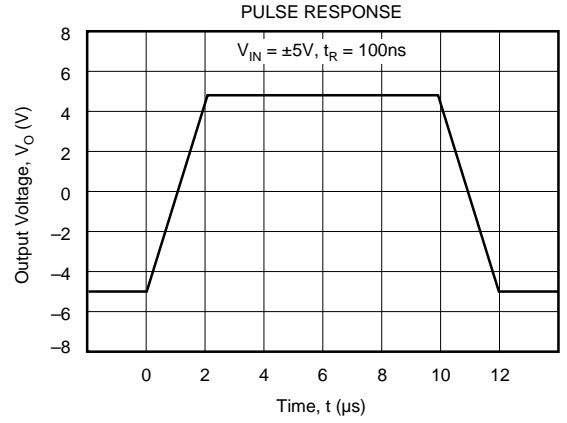
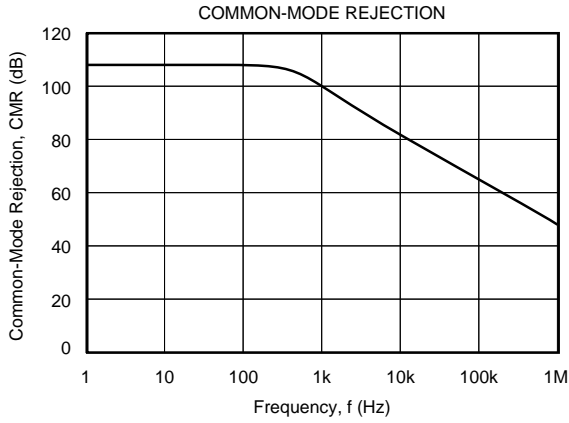

# APPLICATIONS INFORMATION

## POWER SUPPLIES

Specifications for the OPA512 are based on a nominal operating voltage of  $\pm 40V$ . A single power supply or unbalanced supplies may be used as long as the maximum total operating voltage (total of  $+V_S$  and  $-V_S$ ) is not greater than 90V (100V for OPA512SM model.)

## CURRENT LIMITS

Current limit resistors must be provided for proper operation. Independent positive and negative current limit values may be selected by choice of  $R_{CL+}$  and  $R_{CL-}$ , respectively. Resistor values are calculated by:

$$R_{CL} = 0.65/I_{LIM} \text{ (amps)} - 0.007$$

This is the nominal current limit value at room temperature. The maximum output current decreases at high temperature as shown in the typical performance curve. Most wire-wound resistors are satisfactory, but some highly inductive types may cause loop stability problems. Be sure to evaluate performance with the actual resistors to be used in production.

## HEAT SINKING

Power amplifiers are rated by case temperature (not ambient temperature.) The maximum allowable power dissipation is a function of the case temperature as shown in the power derating curve. Load characteristics, signal conditions, and power supply voltage determine the power dissipated by the amplifier. The case temperature will be determined by the heat sinking conditions. Sufficient heat sinking must be provided to keep the case temperature within safe bounds given the power dissipated and ambient temperature. See Application Bulletin AB-038 for further details.

## SAFE OPERATING AREA (SOA)

The safe area plot provides a comprehensive summary of the power handling limitations of a power amplifier, including maximum current, voltage and power as well as the secondary breakdown region (see Figure 1) It shows the allowable output current as a function of the power supply to output voltage differential (voltage across the conducting power device.) See Application Bulletin AB-039 for details on SOA.

## VOLTAGE-CURRENT LIMITER CIRCUITRY

The voltage-current (V-I) limiter circuit provides a means to protect the amplifier from SOA damage such as a short circuit to ground, yet allows high output currents to flow

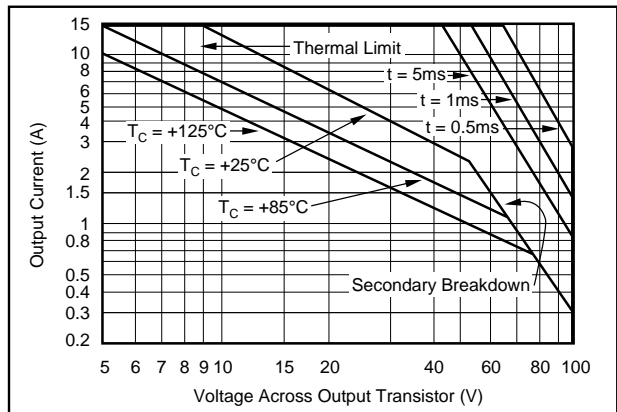

FIGURE 1. Safe Operating Area.

under normal load conditions. Sensing both the output current and the output voltage, this limiter circuit increases the current limit value as the output voltage approaches the power supply voltage (where power dissipation is low.) This type of limiting is achieved by connecting pin 7 through a programming resistor to ground. The V-I limiter circuit is governed by the equation:

$$I_{LIMIT} = \frac{0.65 + \frac{0.28 V_o}{20 + R_{VI}}}{R_{CL} + 0.007}$$

where:

$I_{LIMIT}$  is the maximum current available at a given output voltage.

$R_{VI}$  is the value ( $k\Omega$ ) of the resistor from pin 7 to ground.

$R_{CL}$  is the current limit resistor in ohms.

$V_o$  is the instantaneous output voltage in volts.

Reactive or EMF-generating loads may produce unusual (perhaps undesirable) waveforms with the V-I limit circuit driven into limit. Since current peaks in a reactive load do not align with the output voltage peaks, the output waveform will not appear as a simple voltage-limited waveform. Response of the load to the limiter, in fact, may produce a "backfire" reaction producing unusual output waveforms.