

High Speed, High Voltage Optical Isolator

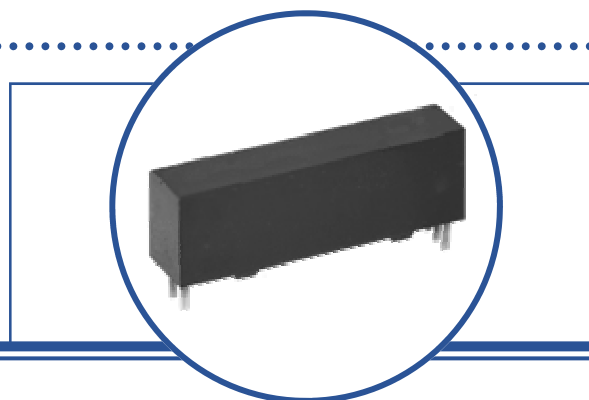

OPI1268

- TTL Compatible Output
- 16KV Isolation
- 2Mbd Transfer Rate
- Creepage Path: 0.970" (24.64mm)
- Air Path: 0.970" (24.64mm)
- Low Propagation Delay Time



The OPI1268 is a high voltage isolator with a digital output which is capable of high speed data transmission. This device is capable of DC and AC voltage isolation between the input and output circuitry while providing TTL signal integrity.

The input of the OPI1268 consists of a high efficiency GaAlAs LED which is optically coupled to the output optical IC. A photodiode in the output IC detects the incoming modulated light and converts it to a proportionate current. This current is fed into a high gain, linear amplifier which is temperature, current and voltage compensated. The result is a highly stable digital output in an open collector inverter configuration.

Applications include:

- High Voltage Isolation
- PCBoard Power System Isolation
- Industrial Equipment Power Isolation
- Medical Equipment Power Isolation

Ordering Information

Please order part number OPI1268

High Speed, High Voltage Optical Isolator

OPI1268



Absolute Maximum Ratings ($T_A = 25^\circ\text{C}$ unless otherwise noted)

Storage Temperature	-40° C to +100° C
Operating Temperature	-40° C to +100° C
Input-to-Output Isolation Voltage	16KVDC ⁽²⁾
Lead Soldering Temperature (1/16" (1.6mm) from case for 5 seconds with soldering iron)	260° C ⁽¹⁾

LED

Forward Current	50 mA
Peak Forward current (2 μs pulse width, 0.1% Duty Cycle)	3.0 A
Reverse DC Voltage	3.0 V
Power Dissipation	100 mW

Output IC –Photologic[®]

Supply Voltage Range	-0.5V to 7.0V
Output Voltage Range	-0.5V to 18.0V
Output Current	25 mA
Power Dissipation	40 mW

Electrical Characteristics ($T_A = 25^\circ\text{C}$ unless otherwise noted)

SYMBOL	PARAMETER	MIN	TYP	MAX	UNITS	TEST CONDITION
Input Diode						
V_F	Forward Voltage		1.3	1.6	V	$I_F = 20\text{mA}$
I_R	Reverse Current			100	μA	$V_R = 3.0\text{V}$
Output IC ($V_{CC} = 4.5\text{V}$ to 5.5V)						
I_{OH}	High Level Output Current		0.25	15	μA	$I_F = 0\text{mA}$, $V_{CC} = 5.25\text{V}$, $V_{OH} = 18.0\text{V}$
V_{OL}	Low Level Output Voltage		0.4	0.5	V	$I_F = 10\text{mA}$, $V_{CC} = 4.5\text{V}$, $I_{OL} = 8.0\text{mA}$
I_{CCH}	High Level Supply Current		2.5	7	mA	$I_F = 0\text{mA}$, $V_{CC} = 5.25\text{V}$
I_{CCL}	Low Level Supply Current		6	10	mA	$I_F = 10\text{mA}$, $V_{CC} = 5.25\text{V}$
Coupled Characteristics ($V_{CC} = 5\text{V}$)						
C_{IO}	Coupling Capacitance			2.0	pF	Input and output leads shorted.
t_{PLH}	Propagation Delay—Low to High			100	ns	See Figures 1 & 2
t_{PHL}	Propagation Delay—High to Low			200	ns	See Figures 1 & 2
$t_{PHL} - t_{PLH}$	Difference in Propagation Delays		100		ns	See Figures 1 & 2
I_{ISO}	Isolation Leakage Current			1.0	μA	$V_{ISO} = 7\text{KV(RMS)}$, input and output leads shorted
I_{F+}	LED Positive Going Threshold Current	0.9	4.0	10.0	mA	$V_{CC} = 5\text{V}$, $I_{OL} = 8.0\text{mA}$

Notes:

- (1) RMA flux is recommended. The duration can be extended to 10 seconds maximum when flow soldering.
- (2) Measured with the input leads and the output leads shorted together. Typical input/output capacitance is 0.05pF.
- (3) Measured with a 1 μs pulse width, 300pps.

High Speed, High Voltage Optical Isolator OPI1268



I_{CCH} & I_{CCL} vs. Ambient Temperature

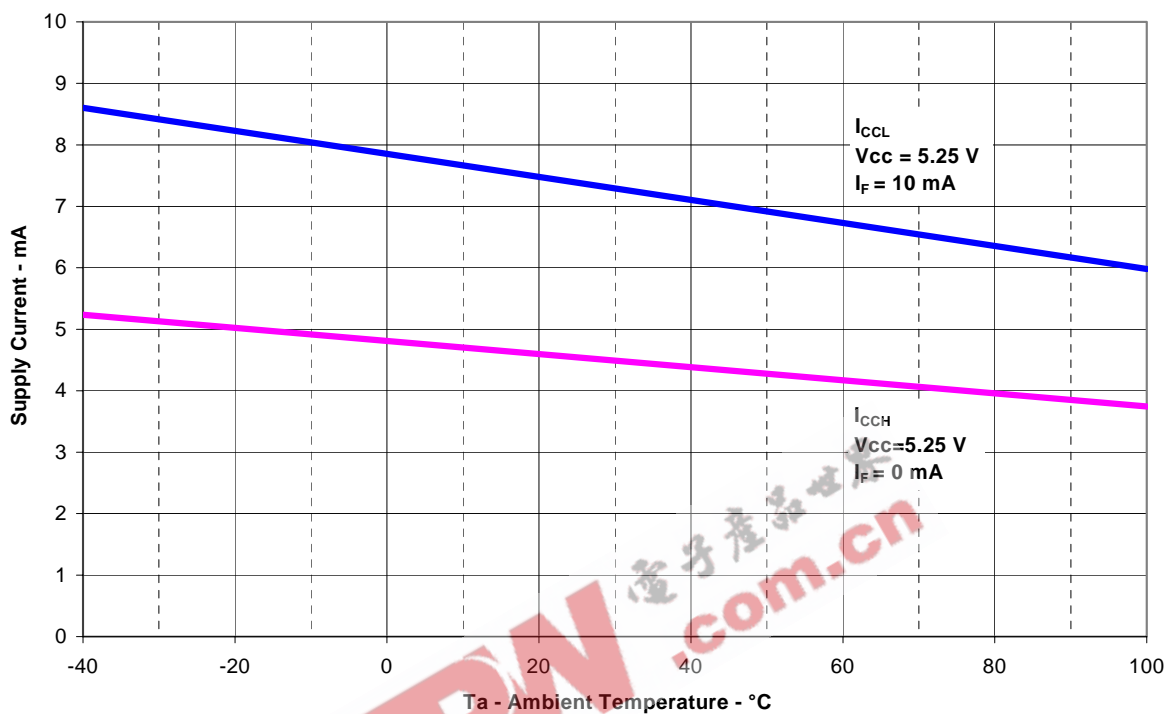

V_{OL} vs. Ambient Temperature

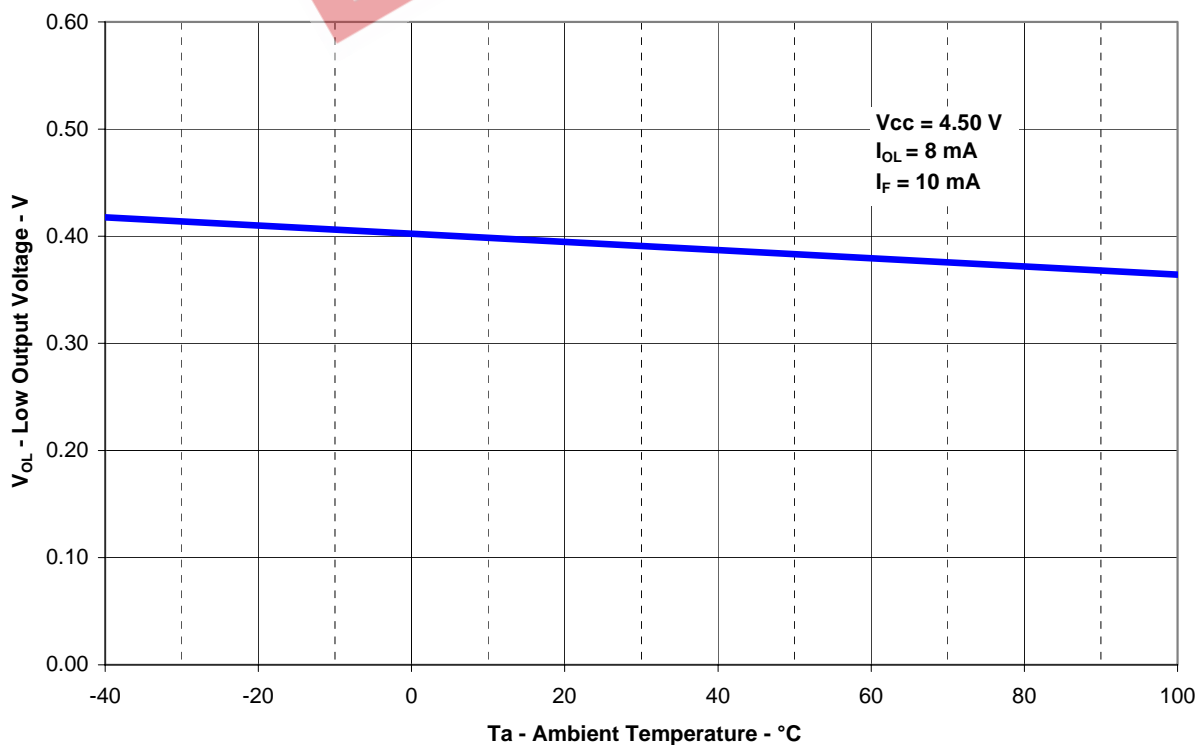

High Speed, High Voltage Optical Isolator OPI1268



$V_{(out)}$ vs I_F

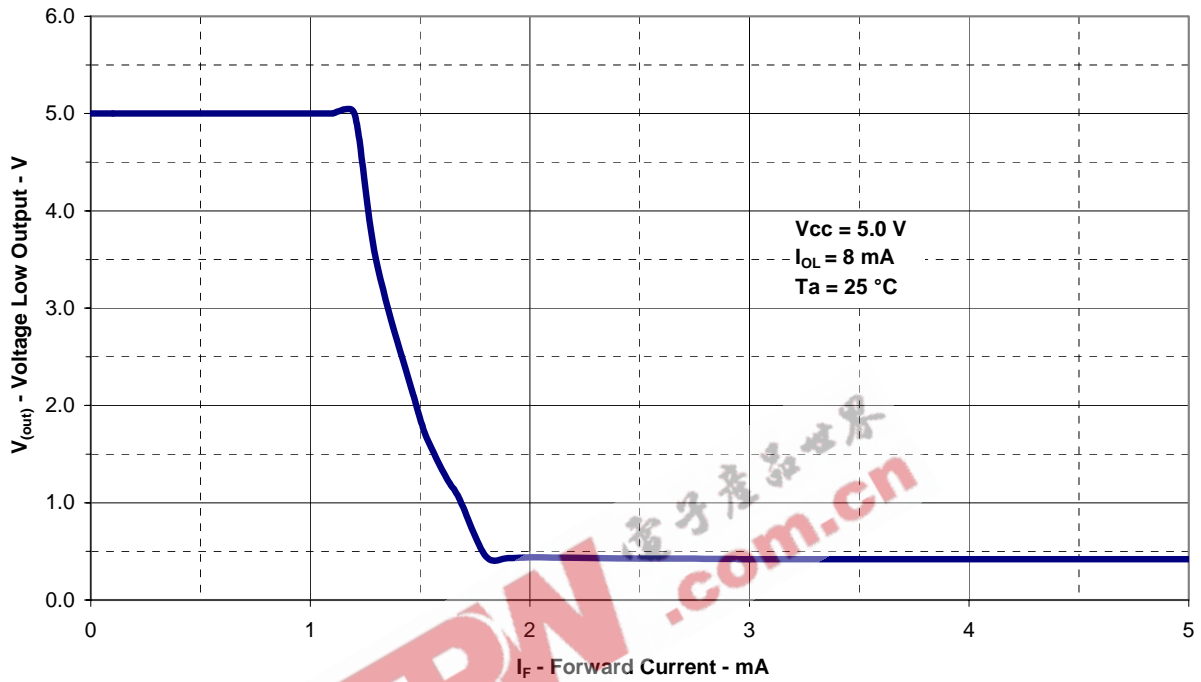

I_{OH} vs. Ambient Temperature

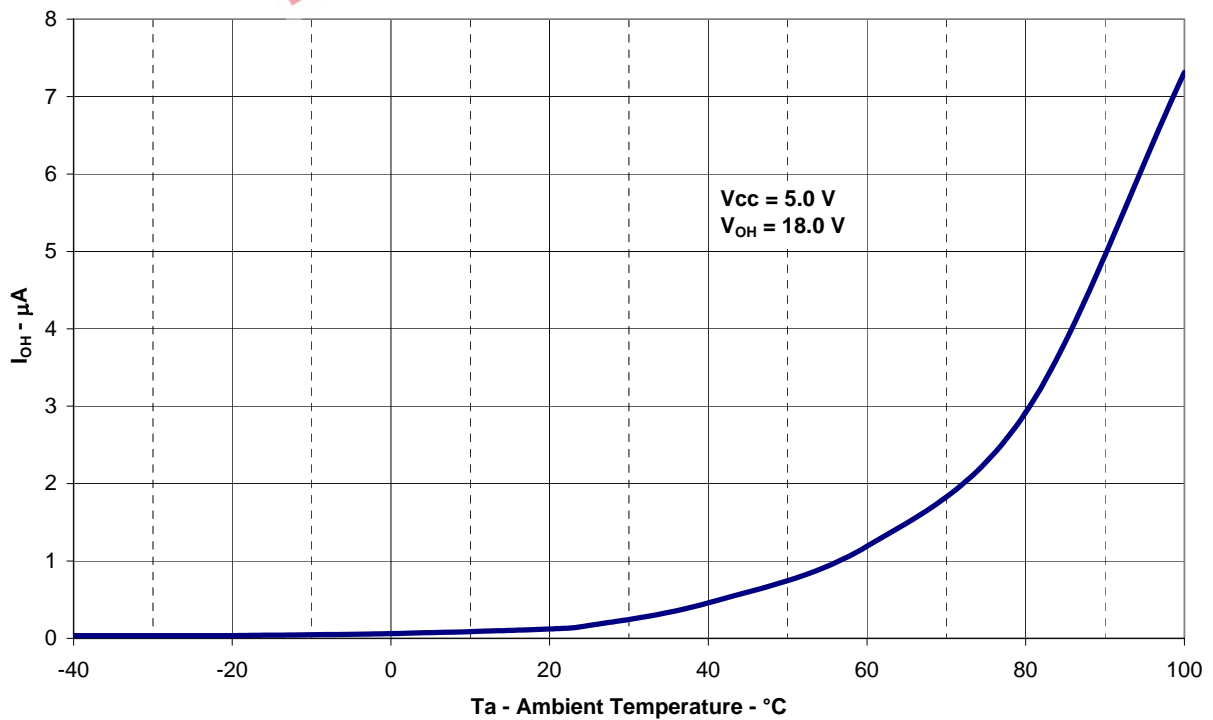

High Speed, High Voltage Optical Isolator OPI1268

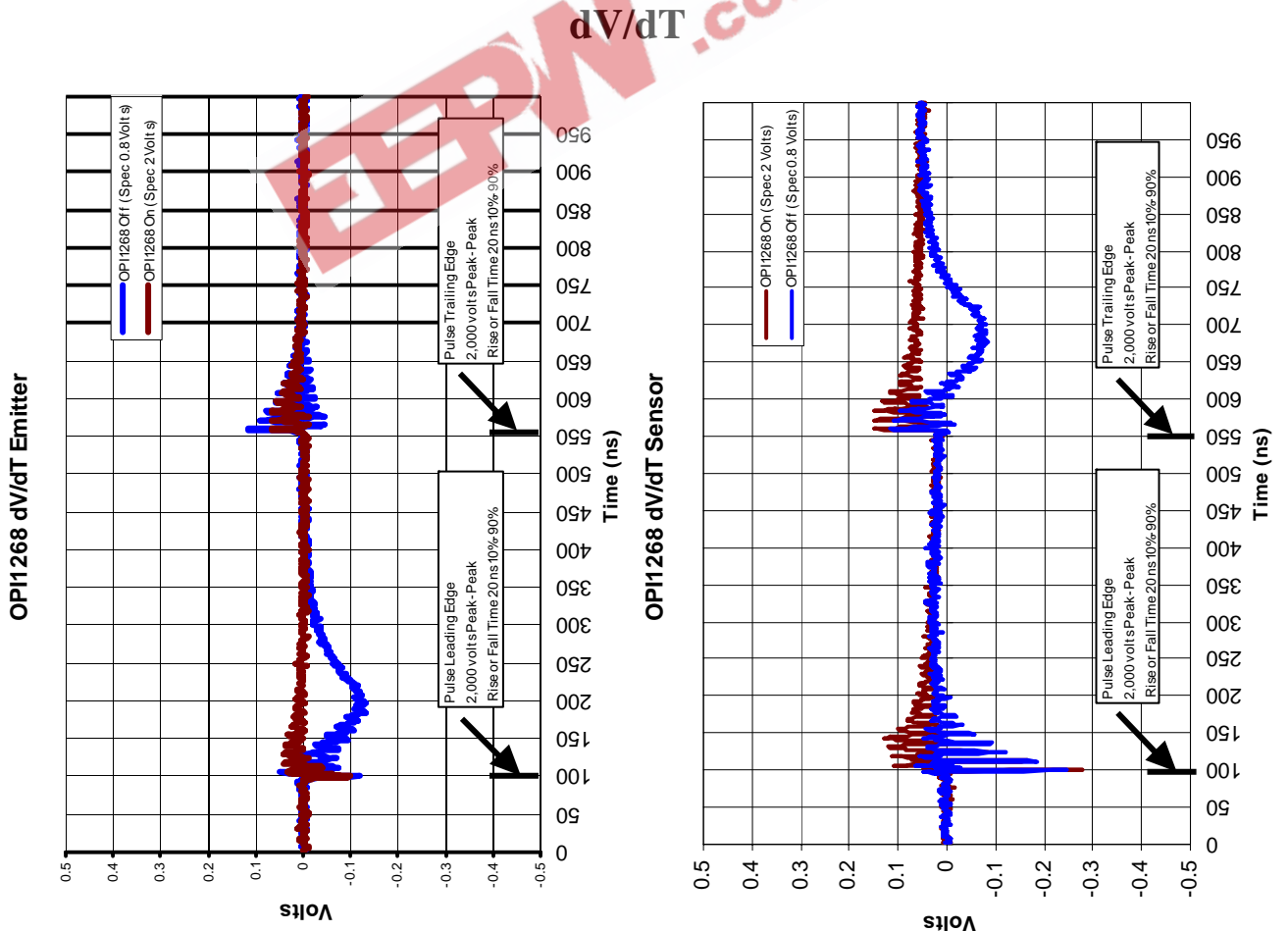
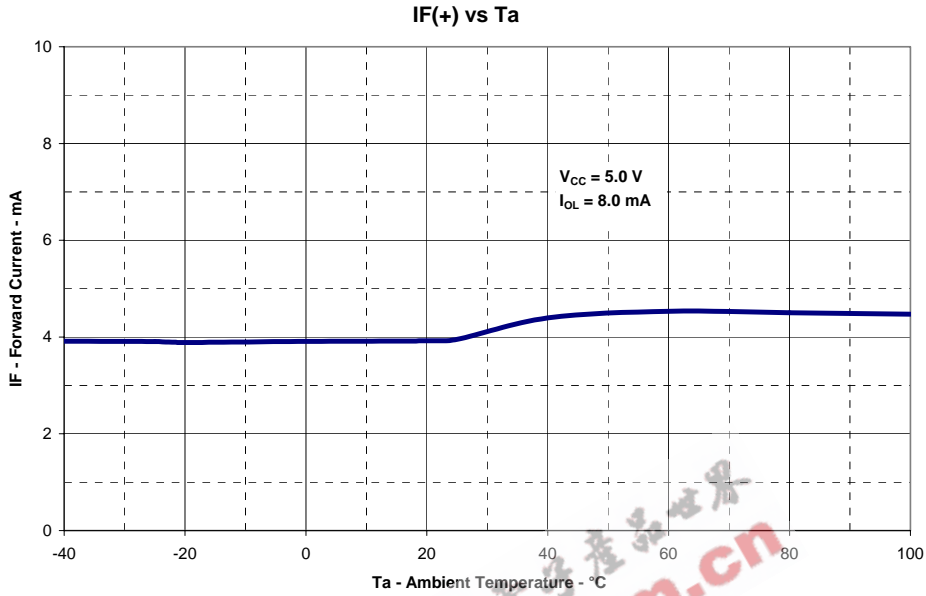

Propogation Delay vs Ambient Temperature

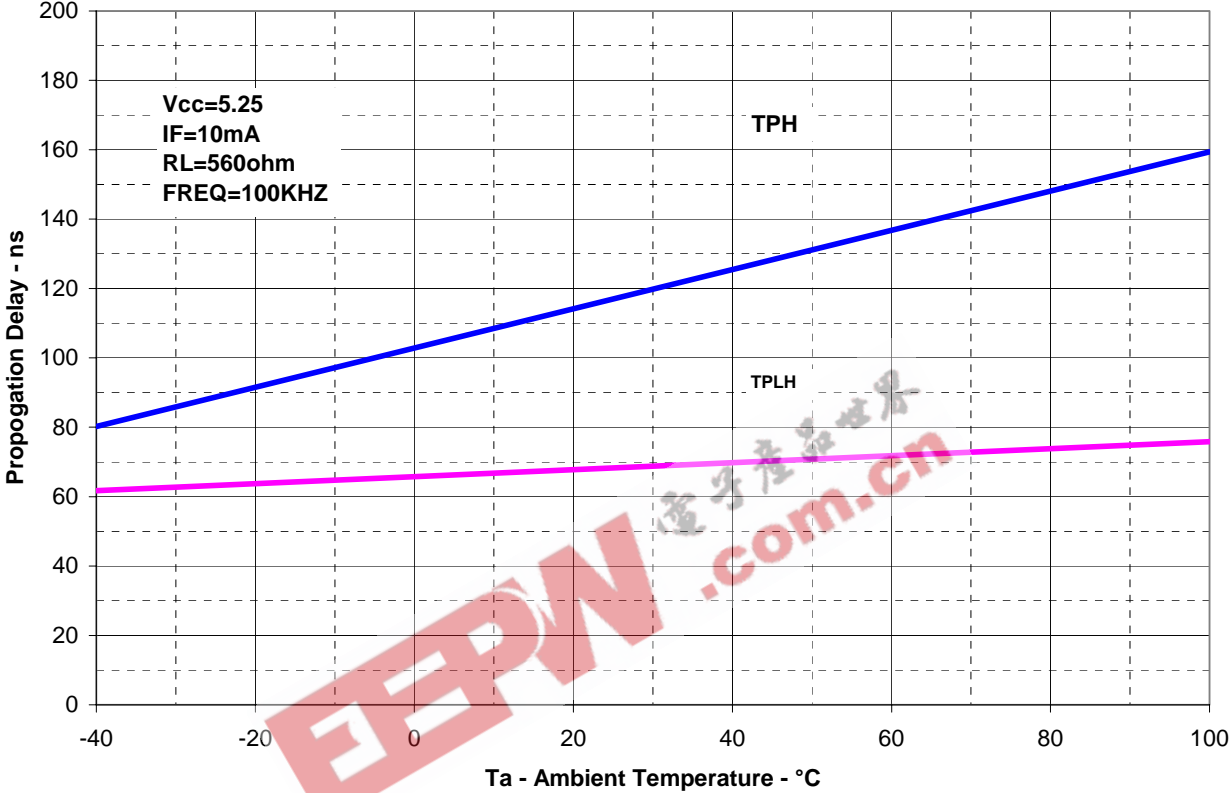

Figure 1: Propagation Delay Test Schematic

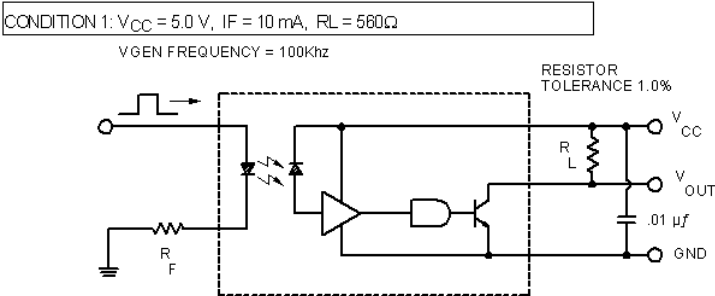
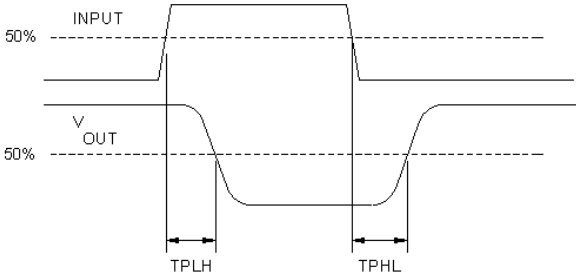

Figure 2: Input/Output Waveforms



High Speed, High Voltage Optical Isolator OPI1268



Mechanical Dimensions:

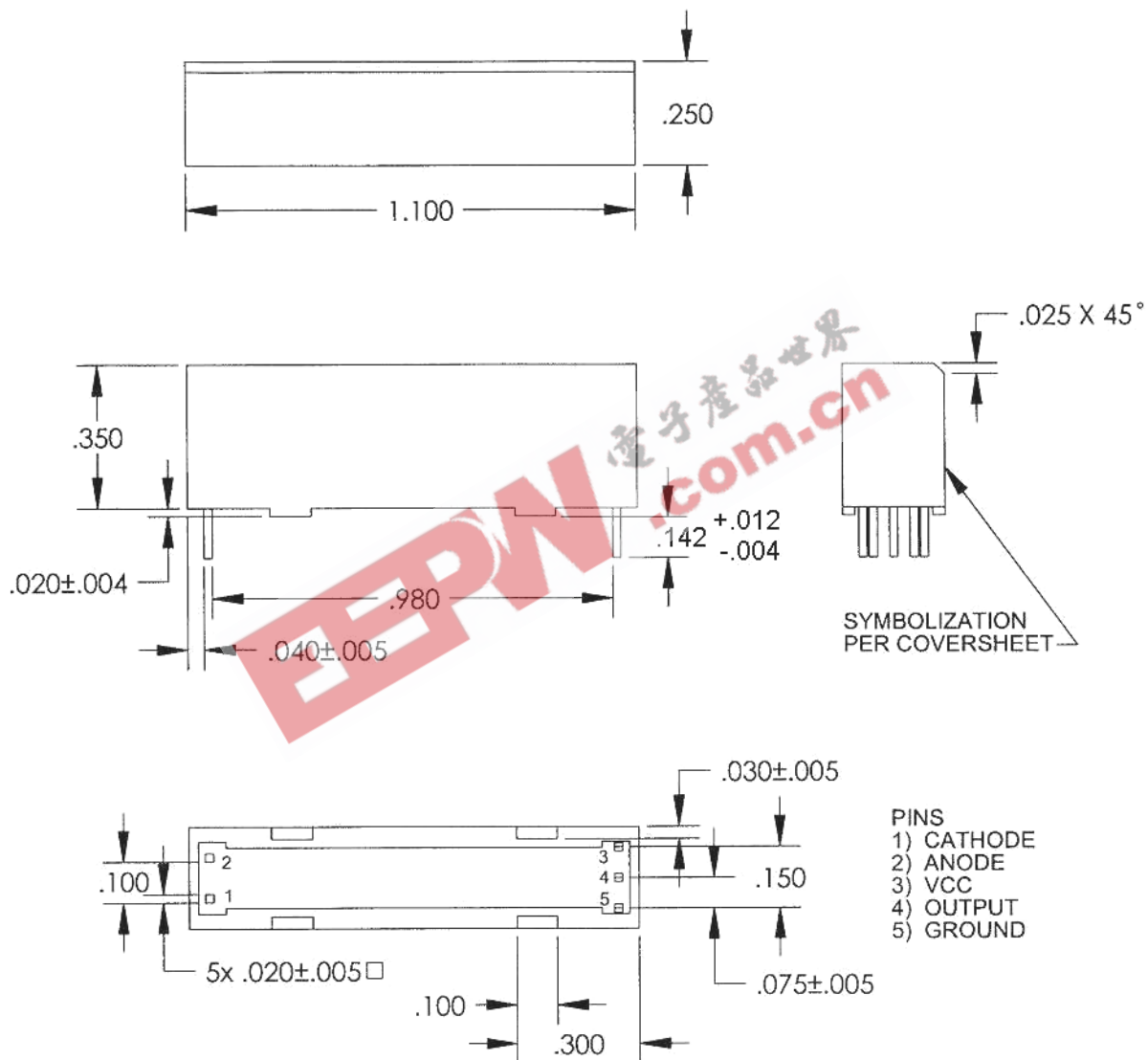

NOTE:
 1) DIMENSIONS $\pm .010$ UNLESS OTHERWISE NOTED.