



Low Power Mobile VGA EMI Reduction IC

Features

- FCC approved method of EMI attenuation
- Provides up to 15 dB EMI reduction
- Generates a low EMI spread spectrum clock and a non-spread reference clock of the input frequency
- Optimized for frequency range from 10 MHz to 160 MHz
 - P1818: 10 to 20 MHz
 - P1819: 20 to 40 MHz
 - P1820: 40 to 80 MHz
 - P1821: 10 to 40 MHz
 - P1822: 80 to 160 MHz
- Internal loop filter minimizes external components and board space
- Selectable spread options: Down Spread and Center Spread
- Low inherent cycle-to-cycle jitter
- Eight spread % selections: +/-0.625% to -3.5%
- 3.3V operating voltage
- CMOS/TTL compatible inputs and outputs
- Low power CMOS design
- Supports notebook VGA and other LCD timing controller applications
- Power down function for mobile application
- Products are available for industrial temperature range.
- Available in 8-pin SOIC and TSSOP

Product Description

The P18xx is a versatile spread spectrum frequency modulator designed specifically for a wide range of input clock frequencies from 10 to 160 MHz (see Input Frequency and Modulation Rate Selections). The P18xx can generate an EMI reduced clock from crystal, ceramic resonator, or system clock. The P18xx-A to P18xx-H offer various combinations of spread options and percentage deviations (see Spread Deviation Selections). These combinations include Down Spread, Center Spread and percentage deviation range from $\pm 0.625\%$ to -3.50% .

The P18xx reduces electromagnetic interference (EMI) at the clock source, allowing a system wide EMI reduction for all the down stream clocks and data dependent signals. The P18xx allows significant system cost savings by reducing the number of circuit board layers, ferrite beads, shielding, and other passive components that are traditionally required to pass EMI regulations.

The P18xx modulates the output of a single PLL in order to "spread" the bandwidth of a synthesized clock, thereby decreasing the peak amplitudes of its harmonics. This results in significantly lower system EMI compared to the typical narrow band signal produced by oscillators and most clock generators. Lowering EMI by increasing a signal's bandwidth is called "spread spectrum clock generation".

The P18xx uses the most efficient and optimized modulation profile approved by the FCC and is implemented by using a proprietary all-digital method.

Applications

The P18xx is targeted toward EMI management for memory and LVDS interfaces in mobile graphic chipsets and high-speed digital applications such as PC peripheral devices, consumer electronics, and embedded controller systems.



Pin Diagrams

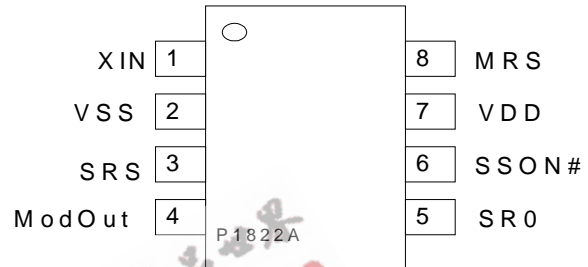
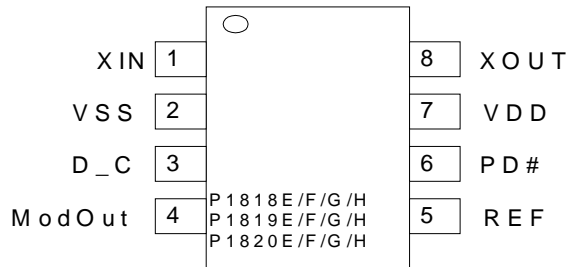
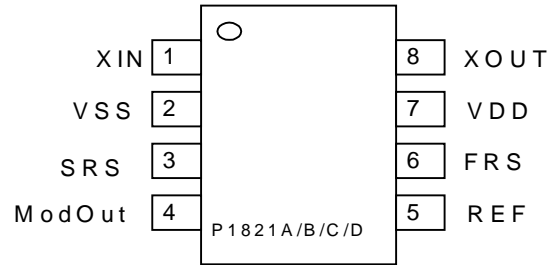
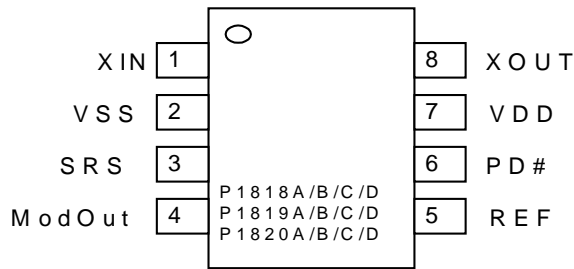

Block Diagram

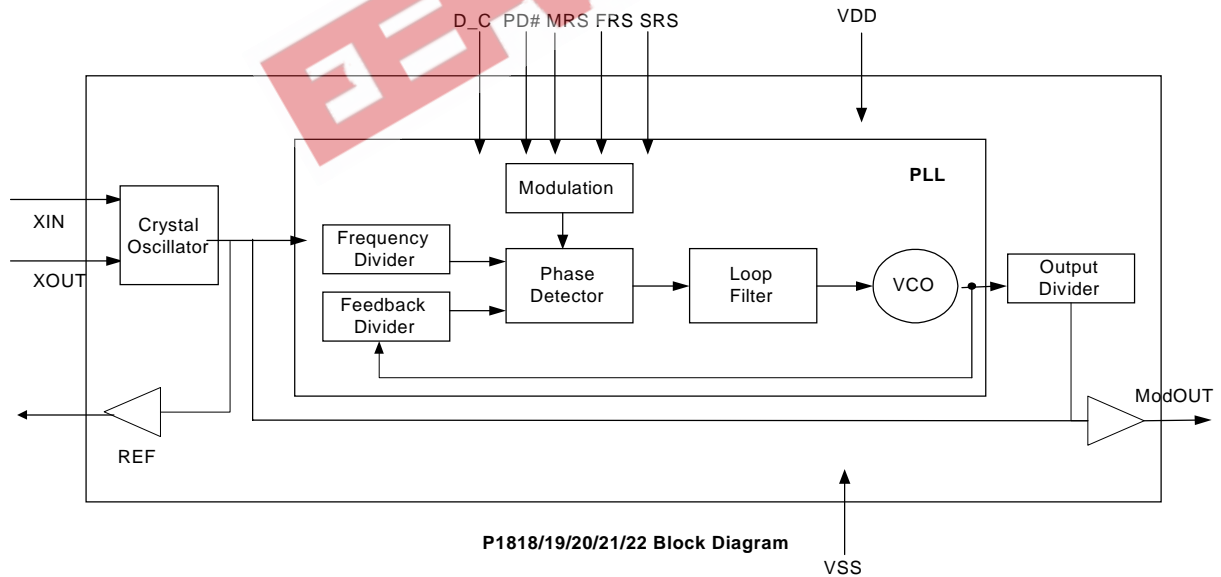



Input Frequency and Modulation Rate

Part number		Input frequency range	Output frequency range	Modulation rate
P1818		10 MHz to 20 MHz	10 MHz to 20 MHz	Input frequency / 256
P1819		20 MHz to 40 MHz	20 MHz to 40 MHz	Input frequency / 512
P1820		40 MHz to 80 MHz	40 MHz to 80 MHz	Input frequency / 2048
P1821	FRS=0	10 MHz to 20 MHz	10 MHz to 20 MHz	Input frequency / 256
	FRS=1	20 MHz to 40 MHz	20 MHz to 40 MHz	Input frequency / 512
P1822		80 MHz to 160 MHz	80 MHz to 160 MHz	Input frequency / 3584

Spread Deviation Selections

Part number ¹	SRS	SR0	D_C	Spread deviation
P1818 ² /19/20/21A	0	N/A	N/A	-2.50% (Down)
	1			-3.50% (Down)
P1818/19/20/21B	0	N/A	N/A	-1.25% (Down)
	1			-1.75% (Down)
P1818/19/20/21C	0	N/A	N/A	+/-1.25% (Center)
	1			+/-1.75% (Center)
P1818/19/20/21D	0	N/A	N/A	+/-0.625% (Center)
	1			+/-0.875% (Center)
P1818/19/20E	N/A	N/A	0	-1.25% (Down)
			1	+/-0.625% (Center)
P1818/19/20F	N/A	N/A	0	-2.5% (Down)
			1	+/-1.25% (Center)
P1818/19/20G	N/A	N/A	0	-1.75% (Down)
			1	+/-0.875% (Center)
P1818 ² /19/20H	N/A	N/A	0	-3.5% (Down)
			1	+/-1.75% (Center)
P1822A	0	0	N/A	-1.25% (Down)
	0	1		-2.50% (Down)
	1	0		-1.75% (Down)
	1	1		-3.50% (Down)
P1822B	0	0	N/A	+/-0.625% (Center)
	0	1		+/-1.25% (Center)
	1	0		+/-0.875% (Center)
	1	1		+/-1.75% (Center)

1. A through H represents various combinations of spread deviations, options, and modulation rates.
2. Refer to Frequency vs. Deviation (P1818A and P1818H).



Frequency vs. Deviation (P1818A and P1818H)

Frequency	Deviation in P1818A		Deviation in P1818H	
	SRS = 1	SRS = 0	D_C = 1	D_C = 0
10 MHz	-4.4%	-3.3%	-4.4%	±2.2%
15 MHz	-1.8%	-1.26%	-1.8%	±0.9%
20 MHz	-0.8%	-0.6%	-0.8%	±0.4%

Pin Description

Pin number	Name	Type	Description
1	XIN	I	Connect to externally generated clock signal or crystal.
2	VSS	P	Ground Connection. Connect to system ground.
3	SRS	I	Spread Range Select. Digital logic input used to select frequency deviation (see Spread Deviation Selections). This pin has an internal pull-up resistor.
3 ¹	D_C	I	Digital logic input used to select Down (LOW) or Center (HIGH) Spread Options (see Spread Deviation Selections). This pin has an internal pull-up resistor.
4	ModOut	O	Spread Spectrum clock output (see Input Frequency and Modulation Rate Selections and Spread Deviation Selections).
5	REF	O	Non-modulated reference output clock of the input frequency.
5/6 ¹	FRS	I	Frequency Range Select. Digital logic input used to select input frequency range (see Input Frequency and Modulation Rate Selections). This pin has an internal pull-up resistor.
6 ¹	PD#	I	Power-Down control pin. Pull LOW to enable Power-Down mode. This pin has an internal pull-up resistor.
7	VDD	P	Connect to +3.3V
8	XOUT	I	Connect to crystal. No connect if externally generated clock signal is used.
8 ¹	MRS	I	Modulation Rate Select. Digital logic input used to select Modulation Rate (see Spread Deviation Selections). This pin has an internal pull-up resistor.

1. Please refer to Figure 1 for pin assignment.



Absolute Maximum Ratings

Symbol	Parameter	Rating	Unit
V_{DD}, V_{IN}	Voltage on any pin with respect to GND	-0.5 to +7.0	V
T_{STG}	Storage temperature	-65 to +125	°C
T_A	Operating temperature	0 to +70	°C

DC Electrical Characteristics

3.3 V, 25° C

Symbol	Parameter	Min	Typ	Max	Unit
V_{IL}	Input low voltage	GND – 0.3	–	0.8	V
V_{IH}	Input high voltage	2.00	–	$V_{DD} + 0.3$	V
I_{IL}	Input low current (inputs D_C, PD#, MRS, FRS, SRS)	-60.0	–	-20.00	μA
I_{IH}	Input high current	–	–	1.00	μA
I_{XOL}	XOUT output low current (@ 0.4 V, $V_{DD} = 3.3$ V)	2.00	–	12.00	mA
I_{XOH}	XOUT output high current (@ 2.5 V, $V_{DD} = 3.3$ V)	–	–	12.00	mA
V_{OL}	Output low voltage ($V_{DD}=3.3$ V, $I_{OL} = 20$ mA)	–	–	0.4	V
V_{OH}	Output high voltage ($V_{DD}=3.3$ V, $I_{OH} = 20$ mA)	–	–	2.8	V
I_{DD}	Static supply current Standby mode	–	4.5	–	mA
I_{CC}	Dynamic supply current Normal mode (3.3 V and 25 pF probe loading)	7.1 f_{IN-min}	–	26.9 f_{IN-max}	mA
V_{DD}	Operating voltage	–	3.3	–	V
t_{ON}	Power up time (first locked clock cycle after power up)	–	0.18	–	mS
Z_{OUT}	Clock output impedance	–	50	–	Ω



AC Electrical Characteristics

3.3 V, 25° C

Symbol	Parameter	Min	Typ	Max	Unit
f_{IN}	Input frequency	10	–	160	MHz
f_{OUT}	Output frequency	10	–	160	MHz
t_{LH}^1	Output rise time (measured at 0.8 V to 2.0 V)	–	0.66	–	ns
t_{HL}^1	Output fall time (measured at 2.0 V to 0.8 V)	–	0.65	–	ns
t_{JC}	Jitter (cycle to cycle) at 20 MHz	-200	–	200	ps
t_D	Output duty cycle	45	50	55	%

1. t_{LH} and t_{HL} are measured into a capacitive load of 15 pF

EEPW 电子产品世界
.com.cn



Mechanical Package Outline (8-Pin SOIC)

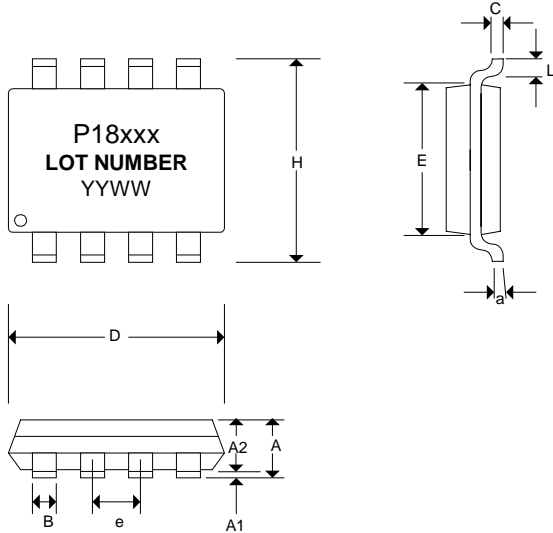

Symbol	Inches			Millimeters		
	Min	Nor	Max	Min	Nor	Max
A	0.057	0.064	0.071	1.45	1.63	1.80
A1	0.004	0.007	0.010	0.10	0.18	0.25
A2	0.053	0.061	0.069	1.35	1.55	1.75
B	0.012	0.016	0.020	0.31	0.41	0.51
C	0.004	0.006	0.01	0.10	0.15	0.25
D	0.186	0.194	0.202	4.72	4.92	5.12
E	0.148	0.156	0.164	3.75	3.95	4.15
e	0.050 BSC			1.27 BSC		
H	0.224	0.236	0.248	5.70	6.00	6.30
L	0.012	0.020	0.028	0.30	0.50	0.70
a	0°	5°	8°	0°	5°	8°

Note: Controlling dimensions are millimeters.
SOIC: 0.074 grams unit weight.

Mechanical Package Outline (8-Pin TSSOP)

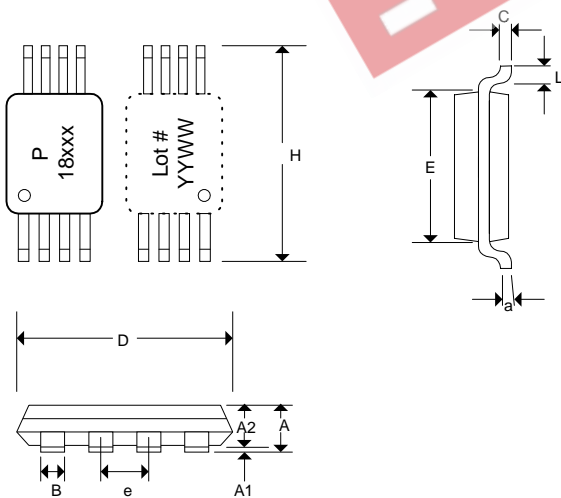

Symbol	Inches			Millimeters		
	Min	Nor	Max	Min	Nor	Max
A	-	-	0.047	-	-	1.10
A1	0.002	-	0.006	0.05	-	0.15
A2	0.031	0.039	0.041	0.80	1.00	1.05
B	0.007	-	0.012	0.19	-	0.30
C	0.004	-	0.008	0.09	-	0.20
D	0.114	0.118	0.122	2.90	3.00	3.10
E	0.169	0.173	0.177	4.30	4.40	4.50
e	0.026 BSC			0.65 BSC		
H	0.244	0.252	0.260	6.20	6.40	6.60
L	0.018	0.024	0.030	0.45	0.60	0.75
a	0°	-	8°	0°	-	8°

Note: Controlling dimensions are millimeters.
TSSOP: 0.034 grams unit weight.



Ordering Information

X	18XX	X	-08	XX
1	2	3	4	5

- Flow prefix:
I = industrial temperature range (-40° C to 85° C)
P = commercial temperature range (0° C to 70° C)
- Device number
- Deviation (%) and spread option identifier
- Device pin count
- Package identifier:
ST = SOIC in tube
SR = SOIC in tape and reel
TT = TSSOP in tube
TR = TSSOP in tape and reel

Example:

Ordering number	Marking	Input frequency (MHz)	Frequency deviation (%)	Package type	Qty. / reel	Temp ¹
P1818A-08ST	P1818A	10 – 20	-2.5, -3.5	8 PIN SOIC, TUBE		0°C to 70°C
P1818A-08SR	P1818A	10 – 20	-2.5, -3.5	8 PIN SOIC, TAPE & REEL	2,500	0°C to 70°C
P1818A-08TT	P1818A	10 – 20	-2.5, -3.5	8 PIN TSSOP, TUBE		0°C to 70°C
P1818A-08TR	P1818A	10 – 20	-2.5, -3.5	8 PIN TSSOP, TAPE & REEL	2,500	0°C to 70°C

- Products are available for industrial temperature range operation. Please contact factory for more information.

Licensed under U.S. patent numbers 5,488,627 and 5,631,920.

© Copyright 2003 Alliance Semiconductor Corporation. All rights reserved. Our three-point logo, our name and Intelliwatt are trademarks or registered trademarks of Alliance. All other brand and product names may be the trademarks of their respective companies. Alliance reserves the right to make changes to this document and its products at any time without notice. Alliance assumes no responsibility for any errors that may appear in this document. The data contained herein represents Alliance's best data and/or estimates at the time of issuance. Alliance reserves the right to change or correct this data at any time, without notice. If the product described herein is under development, significant changes to these specifications are possible. The information in this product data sheet is intended to be general descriptive information for potential customers and users, and is not intended to operate as, or provide, any guarantee or warranty to any user or customer. Alliance does not assume any responsibility or liability arising out of the application or use of any product described herein, and disclaims any express or implied warranties related to the sale and/or use of Alliance products including liability or warranties related to fitness for a particular purpose, merchantability, or infringement of any intellectual property rights, except as express agreed to in Alliance's Terms and Conditions of Sale (which are available from Alliance). All sales of Alliance products are made exclusively according to Alliance's Terms and Conditions of Sale. The purchase of products from Alliance does not convey a license under any patent rights, copyrights, mask works rights, trademarks, or any other intellectual property rights of Alliance or third parties. Alliance does not authorize its products for use as critical components in life-supporting systems where a malfunction or failure may reasonably be expected to result in significant injury to the user, and the inclusion of Alliance products in such life-supporting systems implies that the manufacturer assumes all risk of such use and agrees to indemnify Alliance against all claims arising from such use.