SIDAC[®]

电子产品世界
EPC.com.cn

Data Book and Design Guide

TECCOR ELECTRONICS

1800 Hurd Drive
Irving, Texas 75038
United States of America

Phone: +1 972-580-7777

Fax: +1 972-550-1309

Web site: <http://www.teccor.com>

E-mail: sidactor.techsales@teccor.com

An Invensys company

EEPW 电子产品世界
 .com.cn

SIDACtor[®]

Teccor Electronics is the proprietor of the *SIDACtor*[®], *Battrax*[®], and *TeleLink*[®] trademarks. All other brand names may be trademarks of their respective companies. Teccor Electronics *SIDACtor* products are covered by these and other U.S. Patents:

4,685,120
4,827,497
4,905,119
5,479,031
5,516,705



All SIDACtor products are recognized and listed under UL file E133083 as a UL 497B compliant device. All TeleLink fuses are recognized under UL file E191008 and are also listed for CSA marking by certificate LR 702828.



Teccor Electronics reserves the right to make changes at any time in order to improve designs and to supply the best products possible. The information in this catalog has been carefully checked and is believed to be accurate and reliable; however, no liability of any type shall be incurred by Teccor for the use of the circuits or devices described in this publication. Furthermore, no license of any patent rights is implied or given to any purchaser.

NOTES

EEPW 电子产品世界
.com.cn

1

Product Selection Guide

Product Description	1-2
Product Packages	1-4
Part Number Index	1-6
Description of Part Number	1-8
Electrical Parameters	1-10
Quality and Reliability	1-11
Standard Terms and Conditions	1-12

Product Description

SIDACtor components are solid state crowbar devices designed to protect telecom equipment during hazardous transient conditions. Capitalizing on the latest in thyristor advancements, Teccor makes *SIDACtor* devices with a patented ion implant technology. This technology ensures effective protection within nanoseconds, up to 5000 A surge current ratings, and simple solutions for regulatory requirements such as GR 1089, TIA-968 (formerly known as FCC Part 68), ITU-T K.20, ITU-T K.21, and UL 60950.

Operation

In the standby mode, *SIDACtor* devices exhibit a high off-state impedance, eliminating excessive leakage currents and appearing transparent to the circuits they protect. Upon application of a voltage exceeding the switching voltage (V_S), *SIDACtor* devices crowbar and simulate a short circuit condition until the current flowing through the device is either interrupted or drops below the *SIDACtor* device's holding current (I_H). Once this occurs, *SIDACtor* devices reset and return to their high off-state impedance.

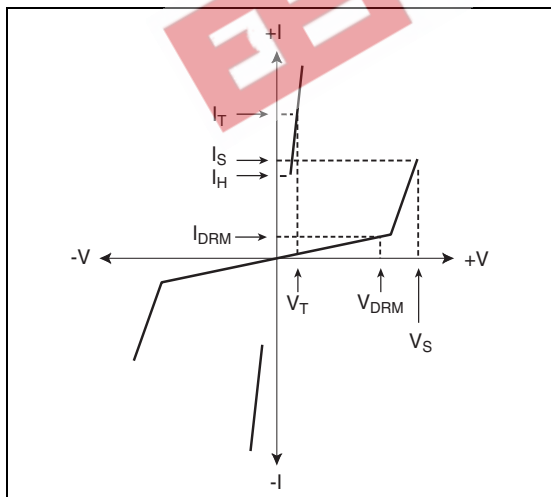

V-I Characteristics

Advantages

Compared to surge suppression using other technologies, *SIDACtor* devices offer absolute surge protection regardless of the surge current available and the rate of applied voltage (dv/dt). *SIDACtor* devices:

- Cannot be damaged by voltage
- Eliminate hysteresis and heat dissipation typically found with clamping devices
- Eliminate voltage overshoot caused by fast-rising transients
- Are non-degenerative
- Will not fatigue
- Have low capacitance, making them ideal for high-speed transmission equipment

Applications



When protecting telecommunication circuits, *SIDACTor* devices are connected across Tip and Ring for metallic protection and across Tip and Ground and Ring and Ground for longitudinal protection. They typically are placed behind some type of current-limiting device, such as Teccor's F1250T *Telelink* slow blow fuse. Common applications include:

- Central office line cards (SLICs)
- T-1/E-1, ISDN, and xDSL transmission equipment
- Customer Premises Equipment (CPE) such as phones, modems, and caller ID adjunct boxes
- PBXs, KSUs, and other switches
- Primary protection including main distribution frames, five-pin modules, building entrance equipment, and station protection modules
- Data lines and security systems
- CATV line amplifiers and power inserters
- Sprinkler systems

For more information regarding specific applications, design requirements, or surge suppression, please contact Teccor Electronics directly at +1 972-580-7777 or through our local area representative. Access Teccor's web site at <http://www.teccor.com> or e-mail us at sidactor.techsales@teccor.com.

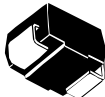
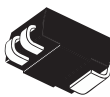
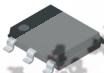
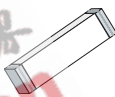
Product Packages

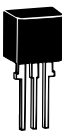
	Surface Mount Packages			
	DO-214AA	Modified DO-214AA	Modified MS-013 Six-pin	Surface Mount (Fuse)
				
Balanced <i>SIDACtor</i> Device			✓	
<i>Battrax</i> Dual Negative SLIC Protector			✓	
<i>Battrax</i> Dual Positive/Negative SLIC Protector			✓	
<i>Battrax</i> Quad Negative SLIC Protector			✓	
<i>Battrax</i> SLIC Protector		✓	✓	
CATV/HFC <i>SIDACtor</i> Device				
CATV Line Amplifiers/Power Inserters <i>SIDACtor</i> Device				
Fixed Voltage SLIC Protector	✓		✓	
Four-port Metallic Line Protector				
High Surge (D-rated) <i>SIDACtor</i> Device	✓			
LCAS Asymmetrical Device	✓		✓	
Longitudinal Protector		✓	✓	
MC Balanced <i>SIDACtor</i> Device			✓	
MC <i>SIDACtor</i> Device	✓		✓	
Multiport Balanced <i>SIDACtor</i> Device			✓	
Multiport Quad SLIC Protector			✓	
Multiport <i>SIDACtor</i> Device			✓	
<i>SIDACtor</i> Device	✓	✓	✓	
<i>TeleLink</i> Fuse				✓
Twin SLIC Protector		✓		

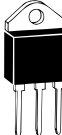
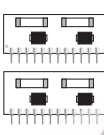
Through-hole Packages					
TO-92	Modified TO-220		TO-218	Hybrid SIP	
					
	✓			✓	Balanced <i>SIDACtor</i> Device
					<i>Battrax</i> Dual Negative SLIC Protector
					<i>Battrax</i> Dual Positive/Negative SLIC Protector
					<i>Battrax</i> Quad Negative SLIC Protector
					<i>Battrax</i> SLIC Protector
		✓	✓		CATV/HFC <i>SIDACtor</i> Device
		✓	✓		CATV Line Amplifiers/Power Inserters <i>SIDACtor</i> Device
✓					Fixed Voltage SLIC Protector
				✓	Four-port Metallic Line Protector
		✓			High Surge (D-rated) <i>SIDACtor</i> Device
					LCAS Asymmetrical Device
	✓			✓	Longitudinal Protector
	✓			✓	MC Balanced <i>SIDACtor</i> Device
✓	✓	✓		✓	MC <i>SIDACtor</i> Device
				✓	Multiport Balanced <i>SIDACtor</i> Device
					Multiport Quad SLIC Protector
				✓	Multiport <i>SIDACtor</i> Device
✓	✓	✓		✓	<i>SIDACtor</i> Device
				✓	<i>TeleLink</i> Fuse
					Twin SLIC Protector

Part Number Index

Note: For explanation of part numbers, see "Description of Part Number" on page 1-8.

Part Number	Page
A1220U_4	2-36
A1225U_4	2-36
A2106A_	2-32
A2106U_	2-20
A2106U_6	2-24
A2106Z_	2-40
A5030A_	2-32
A5030U_	2-20
A5030U_6	2-24
A5030Z_	2-40
B1100C_	2-52
B1101U_	2-54
B1101U_4	2-58
B1160C_	2-52
B1161U_	2-54
B1161U_4	2-58
B1200C_	2-52
B1201U_	2-54
B1201U_4	2-58
B2050C_	2-52
B3104U_	2-56
B3164U_	2-56
B3204U_	2-56
F0500T	2-66
F1250T	2-66
F1251T	2-66
P0080E_	2-16
P0080S_	2-4
P0080SA MC	2-8
P0080SC MC	2-6
P0080SD	2-10
P0080Z_	2-44
P0084U_	2-22
P0300E_	2-16
P0300S_	2-4
P0300SA MC	2-8
P0300SC MC	2-6
P0300SD	2-10
P0300Z_	2-44
P0304U_	2-22

Part Number	Page
P0602A_	2-28
P0602AC MC	2-30
P0602Z_	2-42
P0640E_	2-16
P0640EC MC	2-18
P0640S_	2-4
P0640SC MC	2-6
P0640SD	2-10
P0640Z_	2-44
P0641CA2	2-48
P0641S_	2-46
P0641U_	2-50
P0642S_	2-14
P0644U_	2-22
P0720E_	2-16
P0720S_	2-4
P0720SC MC	2-6
P0720SD	2-10
P0720Z_	2-44
P0721CA2	2-48
P0721S_	2-46
P0721U_	2-50
P0722S_	2-14
P0724U_	2-22
P0900E_	2-16
P0900S_	2-4
P0900SC MC	2-6
P0900SD	2-10
P0900Z_	2-44
P0901CA2	2-48
P0901S_	2-46
P0901U_	2-50
P0902S_	2-14
P0904U_	2-22
P1100E_	2-16
P1100S_	2-4
P1100SC MC	2-6
P1100SD	2-10
P1100Z_	2-44
P1101CA2	2-48

Part Number	Page
P1101S_	2-46
P1101U_	2-50
P1102S_	2-14
P1104U_	2-22
P1200S_	2-38
P1300E_	2-16
P1300S_	2-4
P1300SC MC	2-6
P1300SD	2-10
P1300Z_	2-44
P1304U_	2-22
P1400AD	2-60
P1402A_	2-28
P1402AC MC	2-30
P1402Z_	2-42
P1500E_	2-16
P1500EC MC	2-18
P1500S_	2-4
P1500SC MC	2-6
P1500SD	2-10
P1500Z_	2-44
P1504U_	2-22
P1553A_	2-32
P1553AC MC	2-34
P1553U_	2-20
P1553Z_	2-40
P1556U_	2-24
P1602A_	2-28
P1602AC MC	2-30
P1602Z_	2-42
P1800AD	2-60
P1800E_	2-16
P1800S_	2-4
P1800SC MC	2-6
P1800SD	2-10
P1800Z_	2-44
P1803A_	2-32
P1803AC MC	2-34
P1803U_	2-20
P1803Z_	2-40

Part Number	Page
P1804U_	2-22
P1806U_	2-24
P1900ME	2-64
P2000AA61	2-26
P2000S_	2-38
P2103A_	2-32
P2103AC MC	2-34
P2103U_	2-20
P2103Z_	2-40
P2106U_	2-24
P2200AA61	2-26
P2202A_	2-28
P2202AC MC	2-30
P2202Z_	2-42
P2300E_	2-16
P2300ME	2-64
P2300S_	2-4
P2300SC MC	2-6
P2300SD	2-10
P2300Z_	2-44
P2304U_	2-22
P2353A_	2-32
P2353AC MC	2-34
P2353U_	2-20
P2353Z_	2-40
P2356U_	2-24
P2400AA61	2-26
P2500AA61	2-26
P2500S_	2-38
P2600E_	2-16
P2600EC MC	2-18
P2600S_	2-4
P2600SC MC	2-6
P2600SD	2-10
P2600Z_	2-44
P2604U_	2-22
P2702A_	2-28
P2702AC MC	2-30
P2702Z_	2-42
P2703A_	2-32

Part Number	Page
P2703AC MC	2-34
P2703U_	2-20
P2703Z_	2-40
P2706U_	2-24
P3000AA61	2-26
P3002A_	2-28
P3002AC MC	2-30
P3002CA	2-12
P3002S_	2-14
P3002Z_	2-42
P3100AD	2-62
P3100E_	2-16
P3100EC MC	2-18
P3100S_	2-4
P3100SC MC	2-6
P3100SD	2-10
P3104U_	2-22
P3100Z_	2-44
P3203A_	2-32
P3203AC MC	2-34
P3203U_	2-20
P3203Z_	2-40
P3206U_	2-24
P3300AA61	2-26
P3403A_	2-32
P3403AC MC	2-34
P3403U_	2-20
P3403Z_	2-40
P3406U_	2-24
P3500E_	2-16
P3500S_	2-4
P3500SC MC	2-6
P3500SD	2-10
P3500Z_	2-44
P3504U_	2-22
P3602A_	2-28
P3602AC MC	2-30
P3602Z_	2-42
P4202A_	2-28
P4202AC MC	2-30

Part Number	Page
P4202Z_	2-42
P4802A_	2-28
P4802AC MC	2-30
P4802Z_	2-42
P5103A_	2-32
P5103AC MC	2-34
P5103U_	2-20
P5106U_	2-24
P6002A_	2-28
P6002AC MC	2-30
P6002AD	2-62
P6002CA	2-12
P6002Z_	2-42

Description of Part Number

The following illustration shows a description of a sample *SIDACtor* device part number.

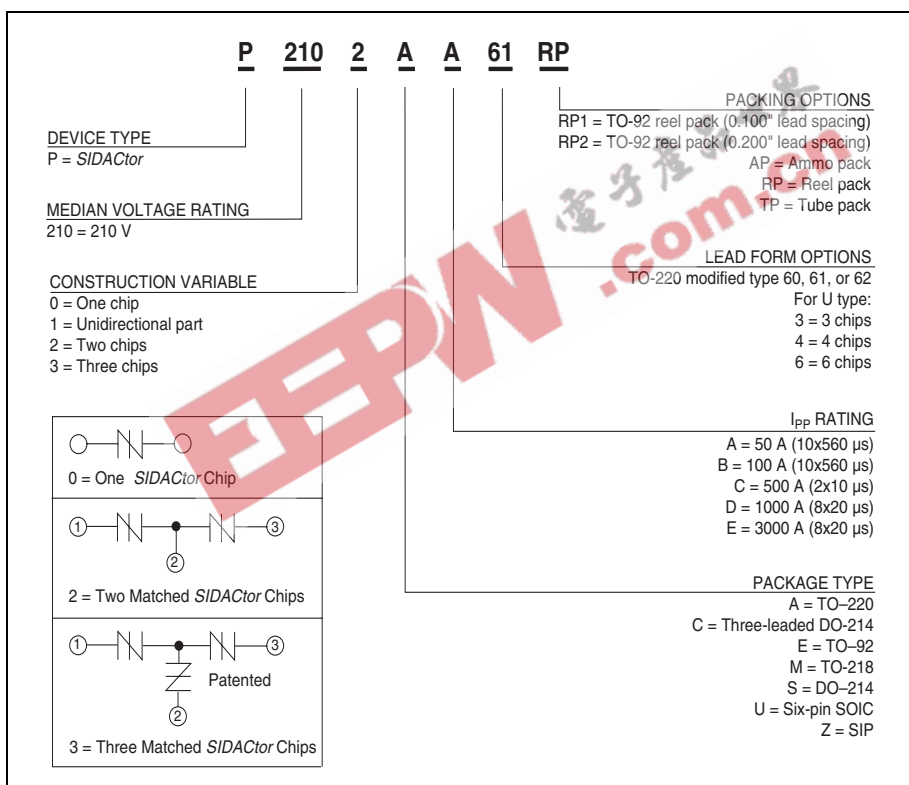

The following illustration shows a description of a sample *Batrax* device part number.

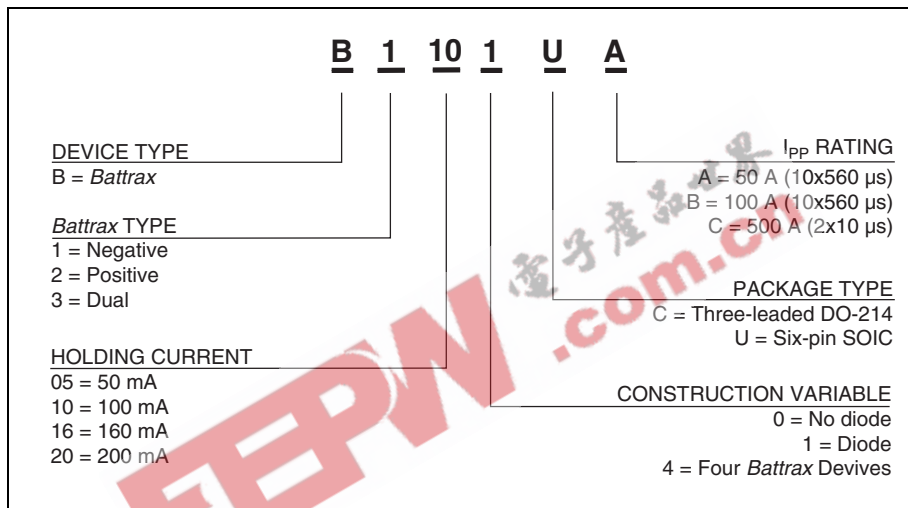

The following illustration shows a description of a sample asymmetrical *SIDACtor* device part number.

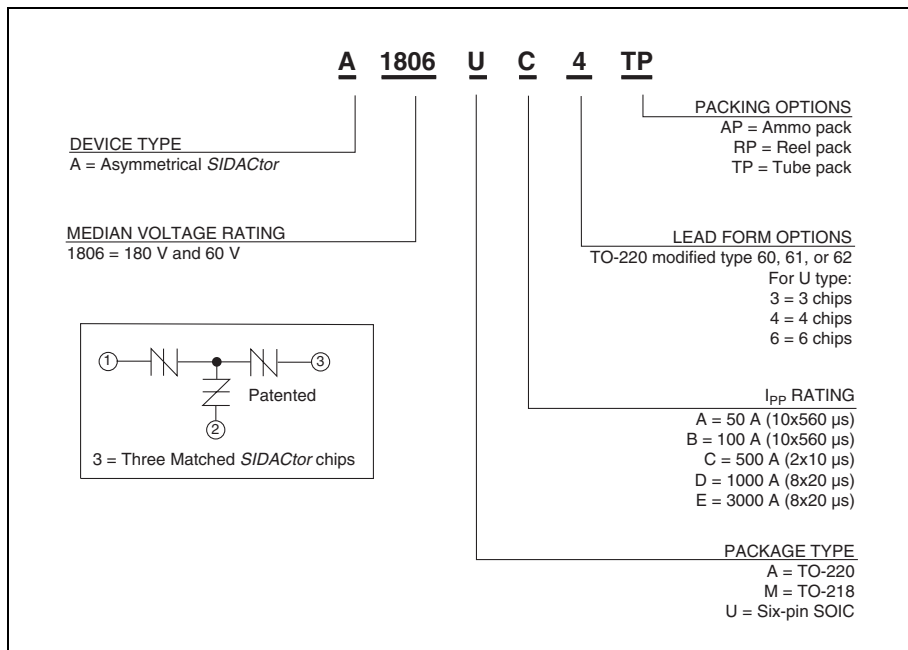

Electrical Parameters

Electrical parameters are based on the following definition of conditions:

- On state (also referred to as the crowbar condition) is the low impedance condition reached during full conduction and simulates a short circuit.
- Off state (also referred to as the blocking condition) is the high impedance condition prior to beginning conduction and simulates an open circuit.

C_O	Off-state Capacitance — typical capacitance measured in off state
di/dt	Rate of Rise of Current — maximum rated value of the acceptable rate of rise in current over time
dv/dt	Rate of Rise of Voltage — rate of applied voltage over time
I_S	Switching Current — maximum current required to switch to on state
I_{DRM}	Leakage Current — maximum peak off-state current measured at V_{DRM}
I_H	Holding Current — minimum current required to maintain on state
I_{PP}	Peak Pulse Current — maximum rated peak impulse current
I_T	On-state Current — maximum rated continuous on-state current
I_{TSM}	Peak One-cycle Surge Current — maximum rated one-cycle AC current
V_S	Switching Voltage — maximum voltage prior to switching to on state
V_{DRM}	Peak Off-state Voltage — maximum voltage that can be applied while maintaining off state
V_F	On-state Forward Voltage — maximum forward voltage measured at rated on-state current
V_T	On-state Voltage — maximum voltage measured at rated on-state current

Quality and Reliability

It is Teccor's policy to ship quality products on time. We accomplish this through Total Quality Management based on the fundamentals of customer focus, continuous improvement, and people involvement.

In support of this commitment, Teccor applies the following principles:

- Employees shall be respected, involved, informed, and qualified for their job with appropriate education, training, and experience.
- Customer expectations shall be met or exceeded by consistently shipping products that meet the agreed specifications, quality levels, quantities, schedules, and test and reliability parameters.
- Suppliers shall be selected by considering quality, service, delivery, and cost of ownership.
- Design of products and processes will be driven by customer needs, reliability, and manufacturability.

It is the responsibility of management to incorporate these principles into policies and systems.

It is the responsibility of those in leadership roles to coach their staff and to reinforce these principles.

It is the responsibility of each individual employee to follow the spirit of this statement to ensure that we meet the primary policy — to ship quality products on time.

Standard Terms and Conditions

Supplier shall not be bound by any term proposed by Buyer in the absence of written agreement to such term signed by an authorized officer of Supplier.

(1) PRICE:

- (A) Supplier reserves the right to change product prices at any time but, whenever practicable, Supplier will give Buyer at least thirty (30) days written notice before the effective date of any price change. Unless Supplier has specifically agreed in writing, signed by an authorized officer of Supplier, that a quoted price shall not be subject to change for a certain time, all products shipped on or after the effective date of a price change may be billed at the new price level.
- (B) Whenever Supplier agrees to a modification of Buyer's order (which modification must be in writing and signed by an authorized officer of Supplier), Supplier reserves the right to alter its price, whether or not such price was quoted as "firm".
- (C) Prices do not include federal, state or local taxes, now or hereafter enacted, applicable to the goods sold. Taxes will be added by Supplier to the sales prices whenever Supplier has legal obligation to collect them and will be paid by Buyer as invoiced unless Buyer provides Supplier with a proper tax exemption certificate.

(2) PRODUCTION: Supplier may, at its sole discretion and at any time, withdraw any catalog item from further production without notice or liability to Buyer.

(3) INTEREST:

- (A) All late payments shall bear interest thirty (30) days after the due date stated on the invoice until paid at the lower of one and one-half percent per month or the maximum rate permitted by law. All interest becoming due shall, if not paid when due, be added to principal and bear interest from the due date. At Supplier's option, any payment shall be applied first to interest and then to principal.
- (B) It is the intention of the parties to comply with the laws of the jurisdiction governing any agreement between the parties relating to interest. If any construction of the agreement between the parties indicates a different right given to Supplier to demand or receive any sum greater than that permissible by law as interest, such as a mistake in calculation or wording, this paragraph shall override. In any contingency which will cause the interest paid or agreed to be paid to exceed the maximum rate permitted by law, such excess will be applied to the reduction of any principal amount due, or if there is no principal amount due, shall be refunded.

(4) TITLE AND DELIVERY: Title to goods ordered by Buyer and risk of loss or damage in transit or thereafter shall pass to Buyer upon Supplier's delivery of the goods at Supplier's plant or to a common carrier for shipment to Buyer.

(5) CONTINGENCIES: Supplier shall not be responsible for any failure to perform due to causes reasonably beyond its control. These causes shall include, but not be restricted to, fire, storm, flood, earthquake, explosion, accident, acts of public enemy, war, rebellion, insurrection, sabotage, epidemic, quarantine restrictions, labor disputes, labor shortages, labor slow downs and sit downs, transportation embargoes, failure or delays in transportation, inability to secure raw materials or machinery for the manufacture of its devices, acts of God, acts of the Federal Government or any agency thereof, acts of any state or local government or agency thereof, and judicial action. Similar causes shall excuse Buyer for failure to take goods ordered by Buyer, from the time Supplier receives written notice from Buyer and for as long as the disabling cause continues, other than for goods already in transit or specially fabricated and not readily saleable to other buyers.

Supplier assumes no responsibility for any tools, dies, and other equipment furnished Supplier by Buyer.

(6) LIMITED WARRANTY AND EXCLUSIVE REMEDY: Supplier warrants all catalog products to be free from defects in materials and workmanship under normal and proper use and application for a period of twelve (12) months from the date code on the product in question (or if none, from the date of delivery to Buyer.) With respect to products assembled, prepared, or manufactured to Buyer's specifications, Supplier warrants only that such products will meet Buyer's specifications upon delivery. As the party responsible for the specifications, Buyer shall be responsible for testing and inspecting the products for adherence to specifications, and Supplier shall have no liability in the absence of such testing and inspection or if the product passes such testing or inspection. THE ABOVE WARRANTY IS THE ONLY WARRANTY EXTENDED BY SUPPLIER, AND IS IN LIEU OF AND EXCLUDES ALL OTHER WARRANTIES AND CONDITIONS, EXPRESSED OR IMPLIED (EXCEPT AS PROVIDED HEREIN AS TO TITLE), ON ANY GOODS OR SERVICES SOLD OR RENDERED BY SUPPLIER, INCLUDING ANY IMPLIED WARRANTIES OF MERCHANTABILITY AND FITNESS FOR A PARTICULAR PURPOSE. THIS WARRANTY WILL NOT CREATE WARRANTY COVERAGE FOR ANY ITEM INTO WHICH ANY PRODUCT SOLD BY SUPPLIER MAY HAVE BEEN INCORPORATED OR ADDED.

SUPPLIER'S ENTIRE LIABILITY AND BUYER'S EXCLUSIVE REMEDY UNDER THIS WARRANTY SHALL BE, AT SUPPLIER'S OPTION, EITHER THE REPLACEMENT OF, REPAIR OF, OR ISSUANCE OF CREDIT TO BUYER'S ACCOUNT WITH SUPPLIER FOR ANY PRODUCTS WHICH ARE PROPERLY RETURNED BY BUYER DURING THE WARRANTY PERIOD. All returns must comply with the following conditions:

- (A) Supplier is to be promptly notified in writing upon discovery of defects by Buyer.
- (B) Buyer must obtain a Return Material Authorization (RMA) number from the Supplier prior to returning product.
- (C) The defective product is returned to Supplier, transportation charges prepaid by Buyer.
- (D) Supplier's examination of such product discloses, to its satisfaction, that such defects have not been caused by misuse, neglect, improper installation, repair, alteration, or accident.
- (E) The product is returned in the form it was delivered with any necessary disassembly carried out by Buyer at Buyer's expense.

IN NO EVENT SHALL SUPPLIER, OR ANYONE ELSE ASSOCIATED IN THE CREATION OF ANY OF SUPPLIER'S PRODUCTS OR SERVICES, BE LIABLE TO BUYER FOR INCIDENTAL OR CONSEQUENTIAL DAMAGES OF ANY NATURE INCLUDING LOSS OF PROFITS, LOSS OF USE, BUSINESS INTERRUPTION, AND THE LIKE. BUYER ACKNOWLEDGES THAT THE ABOVE WARRANTIES AND LIMITATIONS THEREON ARE APPROPRIATE AND REASONABLE IN EFFECTUATING SUPPLIER'S AND BUYER'S MUTUAL INTENTION TO CONDUCT AN EFFICIENT TRANSACTION AT PRICES MORE ADVANTAGEOUS TO BUYER THAN WOULD BE AVAILABLE IN THE PRESENCE OF OTHER WARRANTIES AND ASSURANCES.

- (7) PATENTS: Buyer shall notify Supplier in writing of any claim that any product or any part of use thereof furnished under this agreement constitutes an infringement of any U.S. patent, copyright, trade secret, or other proprietary rights of a third party. Notice shall be given within a reasonable period of time which should in most cases be within ten (10) days of receipt by Buyer of any letter, summons, or complaint pertaining to such a claim. At its option, Supplier may defend at its expense any action brought against Buyer to the extent that it is based on such a claim. Should Supplier choose to defend any such claim, Supplier may fully participate in the defense, settlement, or appeal of any action based on such claim.

Should any product become, or in Supplier's opinion be likely to become, the subject of an action based on any such claim, Supplier may, at its option, as the Buyer's exclusive remedy, either procure for the Buyer the right to continue using the product, replace the product or modify the product to make it noninfringing. IN NO EVENT SHALL SUPPLIER BE LIABLE FOR ANY INCIDENTAL OR CONSEQUENTIAL DAMAGES BASED ON ANY CLAIM OF INFRINGEMENT.

Supplier shall have no liability for any claim based on modifications of a product made by any person or entity other than Supplier, or based on use of a product in conjunction with any other item, unless expressly approved by Supplier. Supplier does not warrant goods against claims of infringement which are assembled, prepared, or manufactured to Buyer's specifications.

- (8) NON-WAIVER OF DEFAULT: Each shipment made under any order shall be treated as a separate transaction, but in the event of any default by Buyer, Supplier may decline to make further shipments without in any way affecting its rights under such order. If, despite any default by Buyer, Supplier elects to continue to make shipments, its action shall not constitute a waiver of that or any default by Buyer or in any way affect Supplier's legal remedies for any such default. At any time, Supplier's failure to exercise any right to remedy available to it shall not constitute a waiver of that right or remedy.
- (9) TERMINATION: If the products to be furnished under this order are to be used in the performance of a Government contract or subcontract, and the Government terminates such contract in whole or part, this order may be canceled to the extent it was to be used in the canceled portion of said Government contract and the liability of Buyer for termination allowances shall be determined by the then applicable regulations of the Government regarding termination of contracts. Supplier may cancel any unfilled orders unless Buyer shall, upon written notice, immediately pay for all goods delivered or shall pay in advance for all goods ordered but not delivered, or both, at Supplier's option.
- (10) LAW: The validity, performance and construction of these terms and conditions and any sale made hereunder shall be governed by the laws of the state of Texas.
- (11) ASSIGNS: This agreement shall not be assignable by either Supplier or Buyer. However, should either Supplier or Buyer be sold or transferred in its entirety and as an ongoing business, or should Supplier or Buyer sell or transfer in its entirety and as an ongoing concern, any division, department, or subsidiary responsible in whole or in part for the performance of this Agreement, this Agreement shall be binding upon and inure to the benefit of those successors and assigns of Supplier, Buyer, or such division, department, or subsidiary.
- (12) MODIFICATION OF STANDARD TERMS AND CONDITIONS: No attempted or suggested modification of or addition to any of the provisions upon the face or reverse of this form, whether contained or arising in correspondence and/or documents passing between Supplier and Buyer, in any course of dealing between Supplier or Buyer, or in any customary usage prevalent among businesses comparable to those of Supplier and/or Buyer, shall be binding upon Supplier unless made and agreed to in writing and signed by an officer of Supplier.
- (13) QUANTITIES: Any variation in quantities of electronic components, or other goods shipped over or under the quantities ordered (not to exceed 5%) shall constitute compliance with Buyer's order and the unit price will continue to apply.

NOTES

EEPW 电子产品世界
.com.cn

2 Data Sheets

This section presents complete electrical specifications for Teccor's *SIDACTor* solid state overvoltage protection devices.

DO-214AA Package Symbolization.....	2-3
DO-214AA	
SIDACTor Device	2-4
MicroCapacitance (MC) SC SIDACTor Device	2-6
MicroCapacitance (MC) SA SIDACTor Device	2-8
High Surge Current (D-rated) SIDACTor Device.....	2-10
Compak Two-chip SIDACTor Device	2-12
Ethernet/10BaseT/100BaseT Protector	2-14
TO-92	
SIDACTor Device	2-16
MicroCapacitance (MC) SIDACTor Device	2-18
Modified MS-013 (Six-pin Surface Mount)	
Balanced Three-chip SIDACTor Device	2-20
Multiport SIDACTor Device	2-22
Multiport Balanced SIDACTor Device	2-24
Modified TO-220	
SIDACTor Device	2-26
Two-chip SIDACTor Device	2-28
Two-chip MicroCapacitance (MC) SIDACTor Device	2-30
Balanced Three-chip SIDACTor Device	2-32
Balanced Three-chip MicroCapacitance (MC) SIDACTor Device.....	2-34
LCAS	
LCAS Asymmetrical Multiport Device	2-36
LCAS Asymmetrical Discrete Device	2-38
SIP Hybrid Overvoltage and Overcurrent Protector	
Four-Port Balanced Three-chip Protector	2-40
Four-Port Longitudinal Two-chip Protector	2-42
Four-Port Metallic Line Protector	2-44
SLICs	
Fixed Voltage SLIC Protector	2-46
Twin SLIC Protector	2-48
Multiport SLIC Protector	2-50
Battrax	
Battrax SLIC Protector	2-52
Battrax Dual Negative SLIC Protector	2-54
Battrax Dual Positive/Negative SLIC Protector	2-56
Battrax Quad Negative SLIC Protector	2-58
CATVs	
CATV and HFC SIDACTor Device	2-60
High Surge Current SIDACTor Device	2-62
CATV Line Amplifiers/Power Inserters SIDACTor Device.....	2-64
TeleLink Fuse	2-66

Acronyms:	CATV	Community Antenna TV
	HFC	Hybrid Fiber Coax
	LCAS	Line Circuit Access Switch
	SIP	Single In-line Package
	SLIC	Subscriber Line Interface Circuit

EEPW 电子产品世界
 .com.cn

DO-214AA Package Symbolization

Part Number	
Catalog	Symbolized
P0080SA	P-8A
P0080SA MC	P-8AM
P0080SB	P-8B
P0080SC	P-8C
P0080SD	P-8D
P0080SC MC	P-8CM
P0300SA	P03A
P0300SA MC	P03AM
P0300SB	P03B
P0300SC	P03C
P0300SD	P03D
P0300SC MC	P03CM
P0640SA	P06A
P0640SB	P06B
P0640SC	P06C
P0640SD	P06D
P0640SC MC	P06CM
P0641CA2	P62A
P0641SA	P61A
P0641SC	P61C
P0720SA	P07A
P0720SB	P07B
P0720SC	P07C
P0720SD	P07D
P0720SC MC	P07CM
P0721CA2	P72A
P0721SA	P71A
P0721SC	P71C
P0900SA	P09A
P0900SB	P09B
P0900SC	P09C
P0900SD	P09D
P0900SC MC	P09CM
P0901CA2	P92A
P0901SA	P91A

Part Number	
Catalog	Symbolized
P0901SC	P91C
P1100SA	P11A
P1100SB	P11B
P1100SC	P11C
P1100SD	P11D
P1100SC MC	P11CM
P1101CA2	P02A
P1101SA	P01A
P1101SC	P01C
P1200SA	P12A
P1200SB	P12B
P1200SC	P12C
P1200SD	P12D
P1200SC MC	P12CM
P1300SA	P13A
P1300SB	P13B
P1300SC	P13C
P1300SD	P13D
P1300SC MC	P13CM
P1500SA	P15A
P1500SB	P15B
P1500SC	P15C
P1500SD	P15D
P1500SC MC	P15CM
P1800SA	P18A
P1800SB	P18B
P1800SC	P18C
P1800SD	P18D
P1800SC MC	P18CM
P2000SA	P20A
P2000SB	P20B
P2000SC	P20C
P2000SD	P20D
P2000SC MC	P20CM
P2300SA	P23A

Part Number	
Catalog	Symbolized
P2300SB	P23B
P2300SC	P23C
P2300SD	P23D
P2300SC MC	P23CM
P2500SA	P25A
P2500SB	P25B
P2500SC	P25C
P2500SD	P25D
P2500SC MC	P25CM
P2600SA	P26A
P2600SB	P26B
P2600SC	P26C
P2600SD	P26D
P2600SC MC	P26CM
P3002CB	P30B
P3002SB	P30B
P3100SA	P31A
P3100SB	P31B
P3100SC	P31C
P3100SD	P31D
P3100SC MC	P31CM
P3500SA	P35A
P3500SB	P35B
P3500SC	P35C
P3500SD	P35D
P3500SC MC	P35CM
P6002CB	P60B
B1100CA	B10A
B1100CC	B10C
B1160CA	B16A
B1160CC	B16C
B1200CA	B12A
B1200CC	B12C
B2050CA	B25A
B2050CC	B25C

Data Sheets

Note: Date code is located below the symbolized part number.

SIDACtor Device



DO-214AA *SIDACtor* solid state protection devices protect telecommunications equipment such as modems, line cards, fax machines, and other CPE.

SIDACtor devices are used to enable equipment to meet various regulatory requirements including GR 1089, ITU K.20, K.21 and K.45, IEC 60950, UL 60950, and TIA-968 (formerly known as FCC Part 68).

Electrical Parameters

Part Number *	V _{DRM} Volts	V _S Volts	V _T Volts	I _{DRM} μ Amps	I _S mAmps	I _T Amps	I _H mAmps	C _o pF
P0080S_	6	25	4	5	800	2.2	50	100
P0300S_	25	40	4	5	800	2.2	50	110
P0640S_	58	77	4	5	800	2.2	150	50
P0720S_	65	88	4	5	800	2.2	150	50
P0900S_	75	98	4	5	800	2.2	150	50
P1100S_	90	130	4	5	800	2.2	150	40
P1300S_	120	160	4	5	800	2.2	150	40
P1500S_	140	180	4	5	800	2.2	150	40
P1800S_	170	220	4	5	800	2.2	150	30
P2300S_	190	260	4	5	800	2.2	150	30
P2600S_	220	300	4	5	800	2.2	150	30
P3100S_	275	350	4	5	800	2.2	150	30
P3500S_	320	400	4	5	800	2.2	150	30

* For individual "SA", "SB", and "SC" surge ratings, see table below.

General Notes:

- All measurements are made at an ambient temperature of 25 °C. I_{PP} applies to -40 °C through +85 °C temperature range.
- I_{PP} is a repetitive surge rating and is guaranteed for the life of the product.
- Listed *SIDACtor* devices are bi-directional. All electrical parameters and surge ratings apply to forward and reverse polarities.
- V_{DRM} is measured at I_{DRM}.
- V_S is measured at 100 V/ μ s.
- Special voltage (V_S and V_{DRM}) and holding current (I_H) requirements are available upon request.
- Off-state capacitance is measured at 1 MHz with a 2 V bias and is a typical value for "SA" and "SB" product. "SC" capacitance is approximately 2x the listed value. The off-state capacitance of the P0080SB is equal to the "SC" device.

Surge Ratings

Series	I _{PP} 2x10 μ s Amps	I _{PP} 8x20 μ s Amps	I _{PP} 10x160 μ s Amps	I _{PP} 10x560 μ s Amps	I _{PP} 10x1000 μ s Amps	I _{TSM} 60 Hz Amps	di/dt Amps/ μ s
A	150	150	90	50	45	20	500
B	250	250	150	100	80	30	500
C	500	400	200	150	100	30	500

Thermal Considerations

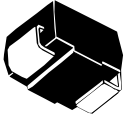
Package	Symbol	Parameter	Value	Unit
	T_J	Operating Junction Temperature Range	-40 to +150	$^{\circ}\text{C}$
	T_S	Storage Temperature Range	-65 to +150	$^{\circ}\text{C}$
	$R_{\theta JA}$	Thermal Resistance: Junction to Ambient	90	$^{\circ}\text{C/W}$

Data Sheets

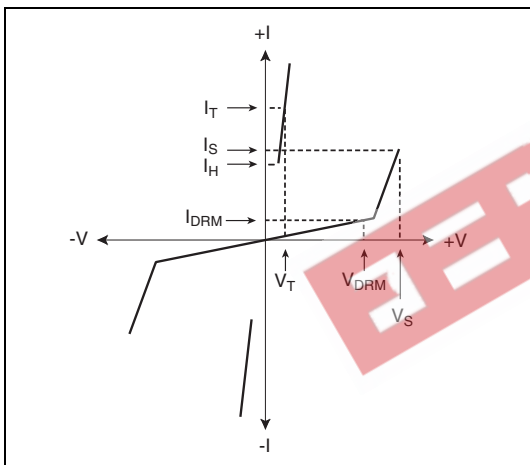

V-I Characteristics

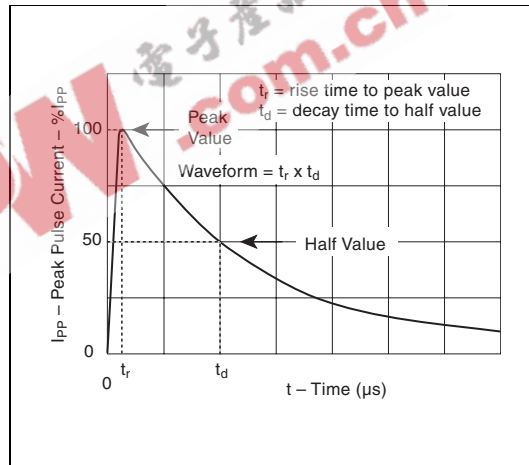

$t_r \times t_d$ Pulse Wave-form

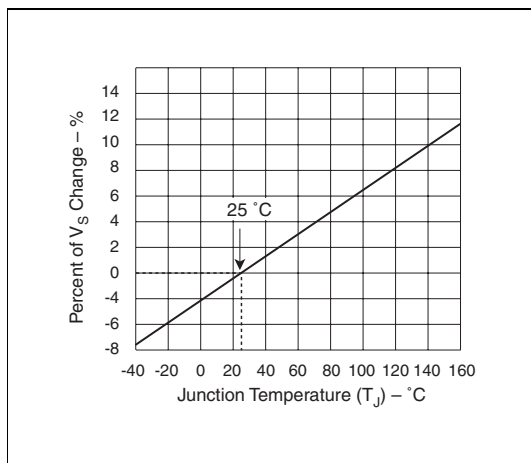

Normalized V_S Change versus Junction Temperature

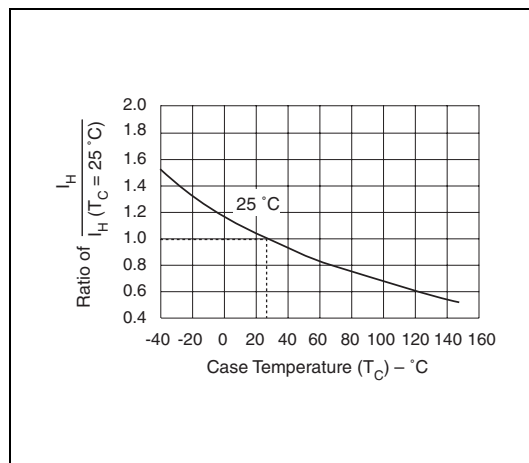

Normalized DC Holding Current versus Case Temperature

MicroCapacitance (MC) SC SIDACtor Device



The DO-214AA SC MC SIDACtor series is intended for applications sensitive to load values. Typically, high speed connections require a lower capacitance. C_O values for the MicroCapacitance device are 40% lower than a standard SC part.

This MC SIDACtor series is used to enable equipment to meet various regulatory requirements including GR 1089, IEC 60950, UL 60950, and TIA-968 (formerly known as FCC Part 68). Contact factory regarding ITU K.20, K.21, and K.45.

Electrical Parameters

Part Number *	V _{DRM} Volts	V _S Volts	V _T Volts	I _{DRM} μ Amps	I _S mAmps	I _T Amps	I _H mAmps	C _O pF
P0080SC MC **	6	25	4	5	800	2.2	50	55
P0300SC MC **	25	40	4	5	800	2.2	50	35
P0640SC MC	58	77	4	5	800	2.2	150	60
P0720SC MC	65	88	4	5	800	2.2	150	60
P0900SC MC	75	98	4	5	800	2.2	150	60
P1100SC MC	90	130	4	5	800	2.2	150	50
P1300SC MC	120	160	4	5	800	2.2	150	50
P1500SC MC	140	180	4	5	800	2.2	150	50
P1800SC MC	170	220	4	5	800	2.2	150	40
P2300SC MC	190	260	4	5	800	2.2	150	40
P2600SC MC	220	300	4	5	800	2.2	150	40
P3100SC MC	275	350	4	5	800	2.2	150	40
P3500SC MC	320	400	4	5	800	2.2	150	40

* For surge ratings, see table below.

** Contact factory for release date.

General Notes:

- All measurements are made at an ambient temperature of 25 °C. I_{PP} applies to -40 °C through +85 °C temperature range.
- I_{PP} is a repetitive surge rating and is guaranteed for the life of the product.
- Listed SIDACtor devices are bi-directional. All electrical parameters and surge ratings apply to forward and reverse polarities.
- V_{DRM} is measured at I_{DRM}.
- V_S is measured at 100 V/ μ s.
- Special voltage (V_S and V_{DRM}) and holding current (I_H) requirements are available upon request.
- Off-state capacitance is measured at 1 MHz with a 2 V bias.

Surge Ratings

Series	I _{PP} 2x10 μ s Amps	I _{PP} 8x20 μ s Amps	I _{PP} 10x160 μ s Amps	I _{PP} 10x560 μ s Amps	I _{PP} 10x1000 μ s Amps	I _{TSM} 60 Hz Amps	di/dt Amps/ μ s
C	500	400	200	150	100	30	500

Thermal Considerations

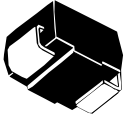
Package	Symbol	Parameter	Value	Unit
	T_J	Operating Junction Temperature Range	-40 to +150	$^{\circ}\text{C}$
	T_S	Storage Temperature Range	-65 to +150	$^{\circ}\text{C}$
	$R_{\theta JA}$	Thermal Resistance: Junction to Ambient	90	$^{\circ}\text{C}/\text{W}$

Data Sheets

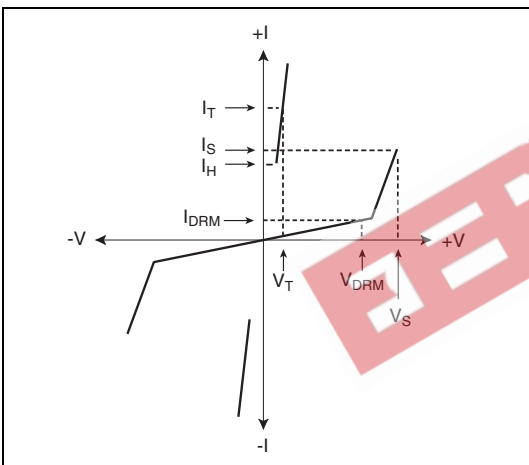

V-I Characteristics

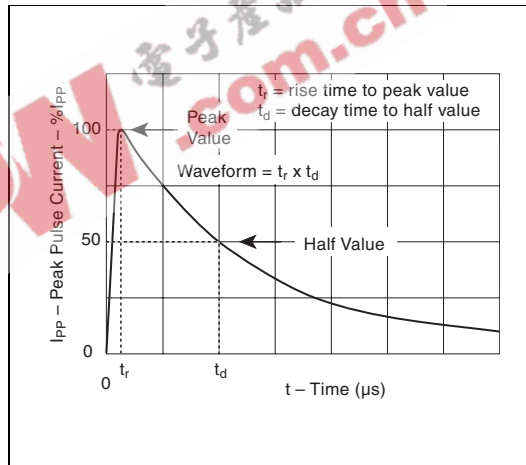

$t_r \times t_d$ Pulse Wave-form

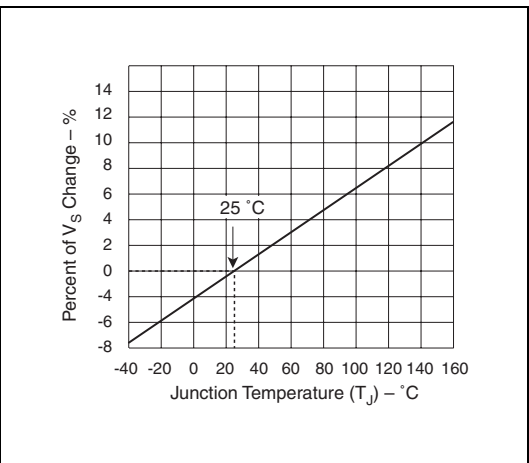

Normalized V_S Change versus Junction Temperature

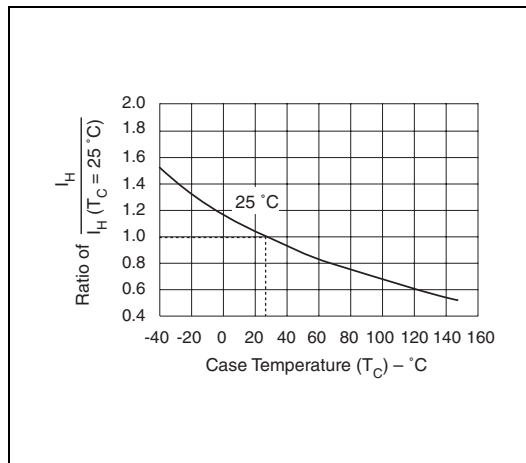

Normalized DC Holding Current versus Case Temperature

MicroCapacitance (MC) SA SIDACTor Device



The DO-214AA SA MC SIDACTor series is intended for applications sensitive to load values. Typically, high speed connections require a lower capacitance. C_O values for the MicroCapacitance device are 40% lower than a standard SA part.

This MC SIDACTor series is used to enable equipment to meet various regulatory requirements including GR 1089, ITU K.20, K.21, and K.45, IEC 60950, UL 60950, and TIA-968 (formerly known as FCC Part 68).

Electrical Parameters

Part Number *	V _{DRM} Volts	V _S Volts	V _T Volts	I _{DRM} μ Amps	I _S mAmps	I _T Amps	I _H mAmps	C _O pF
P0080SA MC	6	25	4	5	800	2.2	50	45
P0300SA MC	25	40	4	5	800	2.2	50	25

* For surge ratings, see table below.

General Notes:

- All measurements are made at an ambient temperature of 25 °C. I_{PP} applies to -40 °C through +85 °C temperature range.
- I_{PP} is a repetitive surge rating and is guaranteed for the life of the product.
- Listed SIDACTor devices are bi-directional. All electrical parameters and surge ratings apply to forward and reverse polarities.
- V_{DRM} is measured at I_{DRM}.
- V_S is measured at 100 V/ μ s.
- Special voltage (V_S and V_{DRM}) and holding current (I_H) requirements are available upon request.
- Off-state capacitance is measured at 1 MHz with a 2 V bias.

Surge Ratings

Series	I _{PP} 2x10 μ s Amps	I _{PP} 8x20 μ s Amps	I _{PP} 10x160 μ s Amps	I _{PP} 10x560 μ s Amps	I _{PP} 10x1000 μ s Amps	I _{TSM} 60 Hz Amps	di/dt Amps/ μ s
A	150	150	90	50	45	20	500

Thermal Considerations

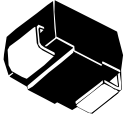
Package	Symbol	Parameter	Value	Unit
	T_J	Operating Junction Temperature Range	-40 to +150	$^{\circ}\text{C}$
	T_S	Storage Temperature Range	-65 to +150	$^{\circ}\text{C}$
	$R_{\theta JA}$	Thermal Resistance: Junction to Ambient	90	$^{\circ}\text{C}/\text{W}$

Data Sheets

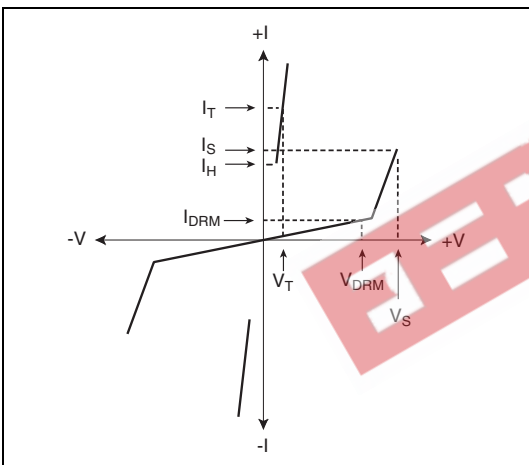

V-I Characteristics

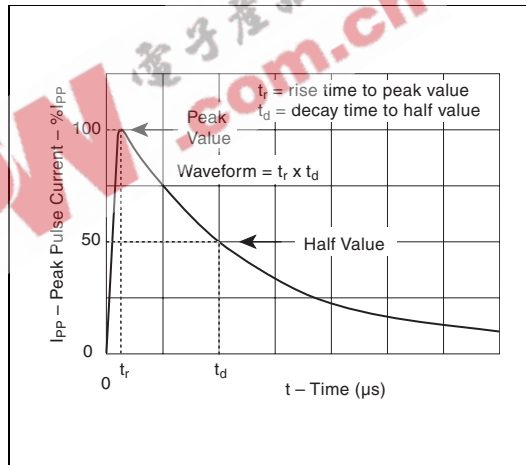

$t_r \times t_d$ Pulse Wave-form

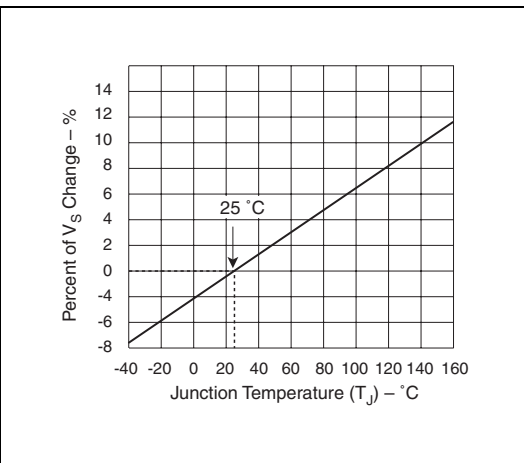

Normalized V_S Change versus Junction Temperature

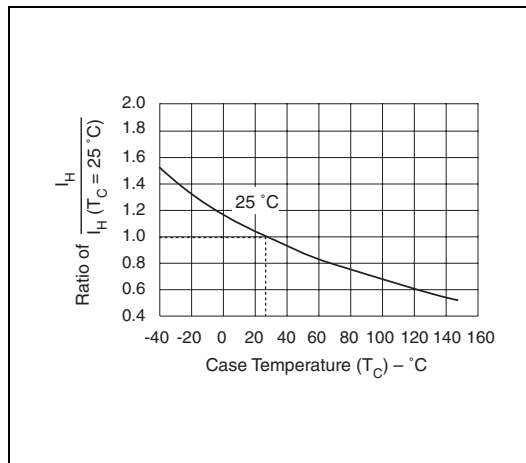

Normalized DC Holding Current versus Case Temperature

High Surge Current (D-rated) SIDACtor Device



DO-214AA SIDACtor solid state protection devices with a D surge rating protect telecommunications equipment such as modems, line cards, fax machines, and other CPE.

These SIDACtor devices withstand simultaneous surges incurred in GR 1089 lightning tests. (See "First Level Lightning Surge Test" on page 4-5.) Surge ratings are twice that of a device with a C surge rating. This allows a discrete surface mount version of Teccor's patented "Y" configuration. (US Patent 4,905,119)

SIDACtor devices are used to enable equipment to meet various regulatory requirements including GR 1089, ITU K.20, K.21 and K.45, IEC 60950, UL 60950, and TIA-968 (formerly known as FCC Part 68).

Electrical Parameters

Part Number *	V _{DRM} Volts	V _S Volts	V _T Volts	I _{DRM} μ Amps	I _S mAmps	I _T Amps	I _H mAmps	C ₀ pF
P0080SD **	6	25	4	5	800	2.2	50	200
P0300SD **	25	40	4	5	800	2.2	50	220
P0640SD **	58	77	4	5	800	2.2	50	100
P0720SD **	65	88	4	5	800	2.2	50	100
P0900SD **	75	98	4	5	800	2.2	50	100
P1100SD	90	130	4	5	800	2.2	50	80
P1300SD	120	160	4	5	800	2.2	50	80
P1500SD	140	180	4	5	800	2.2	50	80
P1800SD	170	220	4	5	800	2.2	50	60
P2300SD	190	260	4	5	800	2.2	50	60
P2600SD	220	300	4	5	800	2.2	50	60
P3100SD	275	350	4	5	800	2.2	50	60
P3500SD	320	400	4	5	800	2.2	50	60

* For surge ratings, see table below.

** Contact factory for release date.

General Notes:

- All measurements are made at an ambient temperature of 25 °C. I_{PP} applies to -40 °C through +85 °C temperature range.
- I_{PP} is a repetitive surge rating and is guaranteed for the life of the product.
- Listed SIDACtor devices are bi-directional. All electrical parameters and surge ratings apply to forward and reverse polarities.
- V_{DRM} is measured at I_{DRM}.
- V_S is measured at 100 V/ μ s.
- Special voltage (V_S and V_{DRM}) and holding current (I_H) requirements are available upon request.
- Off-state capacitance is measured at 1 MHz with a 2 V bias and is a typical value.

Surge Ratings

Series	I _{PP} 2x10 μ s Amps	I _{PP} 8x20 μ s Amps	I _{PP} 10x160 μ s Amps	I _{PP} 10x560 μ s Amps	I _{PP} 10x1000 μ s Amps	I _{TSM} 60 Hz Amps	di/dt Amps/ μ s
D	1000	800	400	300	200	50	1000

Thermal Considerations

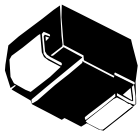
Package	Symbol	Parameter	Value	Unit
	T_J	Operating Junction Temperature Range	-40 to +150	$^{\circ}\text{C}$
	T_S	Storage Temperature Range	-65 to +150	$^{\circ}\text{C}$
	$R_{\theta JA}$	Thermal Resistance: Junction to Ambient	90	$^{\circ}\text{C/W}$

Data Sheets

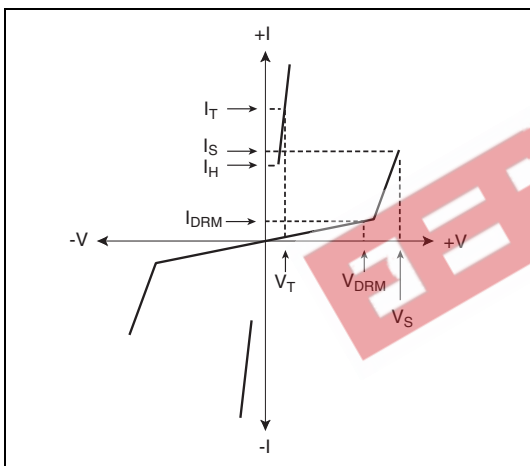

V-I Characteristics

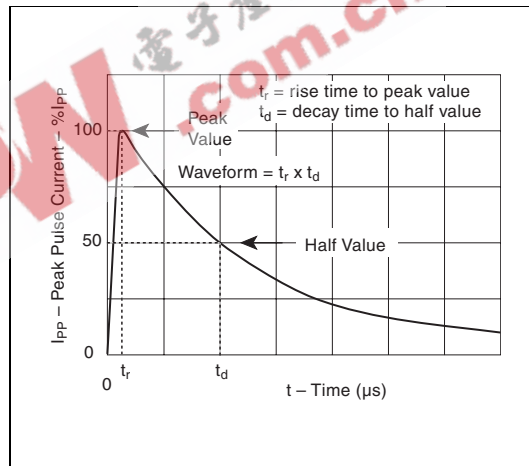

$t_r \times t_d$ Pulse Wave-form

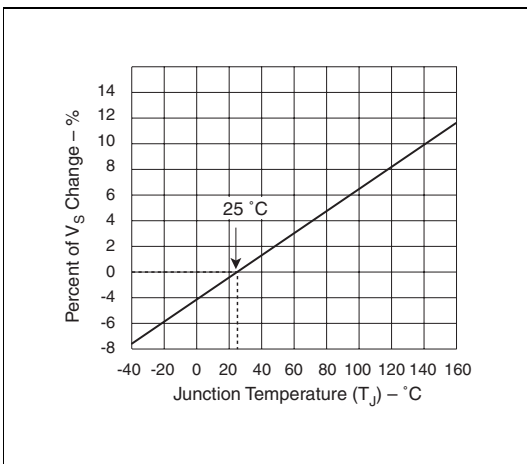

Normalized V_S Change versus Junction Temperature

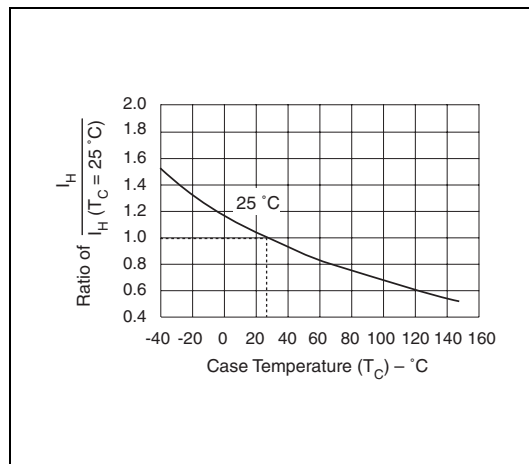

Normalized DC Holding Current versus Case Temperature

Compak Two-chip SIDACtor Device

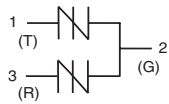

The modified DO-214AA SIDACtor device provides low-cost, longitudinal protection.

SIDACtor devices are used to enable equipment to meet various regulatory requirements including GR 1089, ITU K.20, K.21, and K.45, IEC 60950, UL 60950, and TIA-968 (formerly known as FCC Part 68).

Electrical Parameters

Part Number	V _{DRM} Volts	V _S Volts	V _{DRM} Volts	V _S Volts	V _T Volts	I _{DRM} μ Amps	I _S mAmps	I _T Amps	I _H mAmps	C _O pF
	Pins 1-2, 2-3		Pins 1-3							
P3002CA	140	180	280	360	4	5	800	1	120	15
P6002CA	275	350	550	700	4	5	800	1	120	15

* For surge ratings, see table below.

General Notes:

- All measurements are made at an ambient temperature of 25 °C. I_{PP} applies to -40 °C through +85 °C temperature range.
- I_{PP} is a repetitive surge rating and is guaranteed for the life of the product.
- Listed SIDACtor devices are bi-directional. All electrical parameters and surge ratings apply to forward and reverse polarities.
- V_{DRM} is measured at I_{DRM}.
- V_S is measured at 100 V/ μ s.
- Special voltage (V_S and V_{DRM}) and holding current (I_H) requirements are available upon request.
- Off-state capacitance is measured between Pins 1-3 at 1 MHz with a 2 V bias.
- UL 60950 creepage requirements must be considered.

Surge Ratings

Series	I _{PP} 2x10 μ s Amps	I _{PP} 8x20 μ s Amps	I _{PP} 10x160 μ s Amps	I _{PP} 10x560 μ s Amps	I _{PP} 10x1000 μ s Amps	I _{TSM} 60 Hz Amps	di/dt Amps/ μ s
A	150	150	90	50	45	20	500

Thermal Considerations

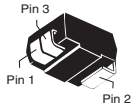
Package	Symbol	Parameter	Value	Unit
	T_J	Operating Junction Temperature Range	-40 to +150	$^{\circ}\text{C}$
	T_S	Storage Temperature Range	-65 to +150	$^{\circ}\text{C}$
	$R_{\theta JA}$	Thermal Resistance: Junction to Ambient	85	$^{\circ}\text{C}/\text{W}$

Data Sheets

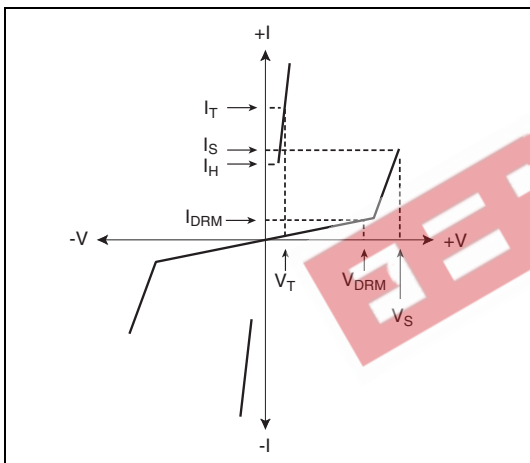

V-I Characteristics

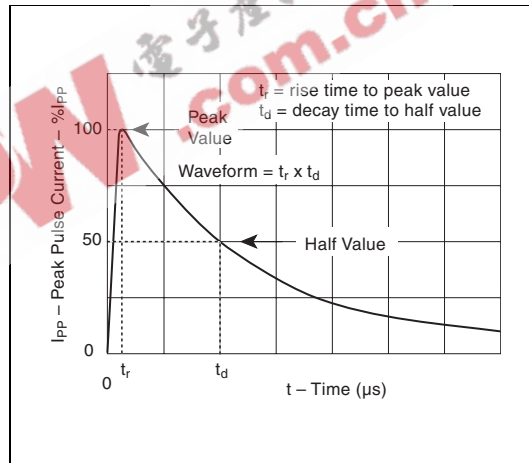

$t_r \times t_d$ Pulse Wave-form

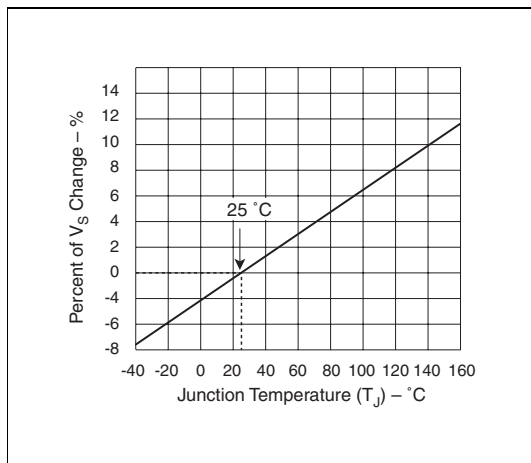

Normalized V_S Change versus Junction Temperature

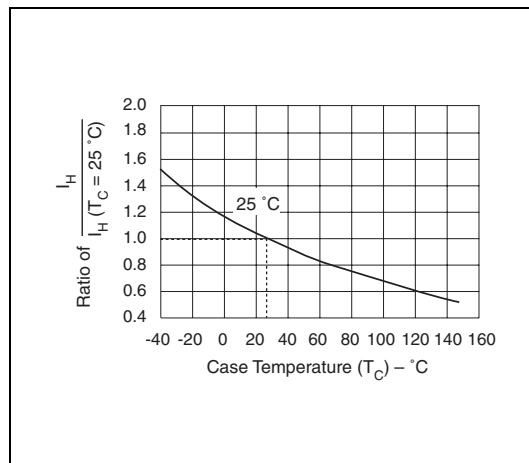

Normalized DC Holding Current versus Case Temperature

Ethernet/10BaseT/100BaseT Protector



The DO-214AA *SIDACTor* Ethernet protection series is intended for applications sensitive to load values. Typically, high speed connections require a lower capacitance. C_o values are 40% lower than standard devices.

SIDACTor devices are used to enable equipment to meet various regulatory requirements including GR 1089, ITU K.20, K.21 and K.45, IEC 60950, UL 60950, and TIA-968 (formerly known as FCC Part 68).

Electrical Parameters

Part Number *	V_{DRM} Volts	V_S Volts	V_T Volts	I_{DRM} μ Amps	I_S mAmps	I_T Amps	I_H mAmps	C_o pF
P0642S_	58	77	4	5	800	2.2	120	25
P0722S_	65	88	4	5	800	2.2	120	25
P0902S_	75	98	4	5	800	2.2	120	25
P1102S_	90	130	4	5	800	2.2	120	20
P3002S_	280	360	4	5	800	2.2	120	15

* For surge ratings, see table below.

General Notes:

- All measurements are made at an ambient temperature of 25 °C. I_{PP} applies to -40 °C through +85 °C temperature range.
- I_{PP} is a repetitive surge rating and is guaranteed for the life of the product.
- Listed *SIDACTor* devices are bi-directional. All electrical parameters and surge ratings apply to forward and reverse polarities.
- V_{DRM} is measured at I_{DRM} .
- V_S is measured at 100 V/ μ s.
- Special voltage (V_S and V_{DRM}) and holding current (I_H) requirements are available upon request.
- Off-state capacitance is measured at 1 MHz with a 2 V bias.

Surge Ratings

Series	I_{PP} 2x10 μ s Amps	I_{PP} 8x20 μ s Amps	I_{PP} 10x160 μ s Amps	I_{PP} 10x560 μ s Amps	I_{PP} 10x1000 μ s Amps	I_{TSM} 60 Hz Amps	di/dt Amps/ μ s
A	150	150	90	50	45	20	500
B**	250	250	150	100	80	30	500

** Contact factory for release date of B-rated devices.

Thermal Considerations

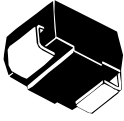
Package	Symbol	Parameter	Value	Unit
	T_J	Operating Junction Temperature Range	-40 to +150	$^{\circ}\text{C}$
	T_S	Storage Temperature Range	-65 to +150	$^{\circ}\text{C}$
	$R_{\theta JA}$	Thermal Resistance: Junction to Ambient	90	$^{\circ}\text{C/W}$

Data Sheets

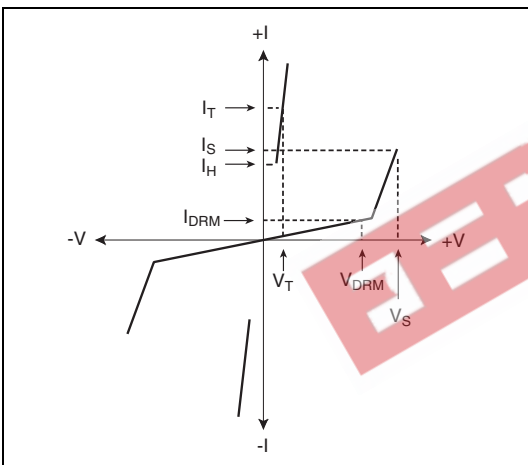

V-I Characteristics

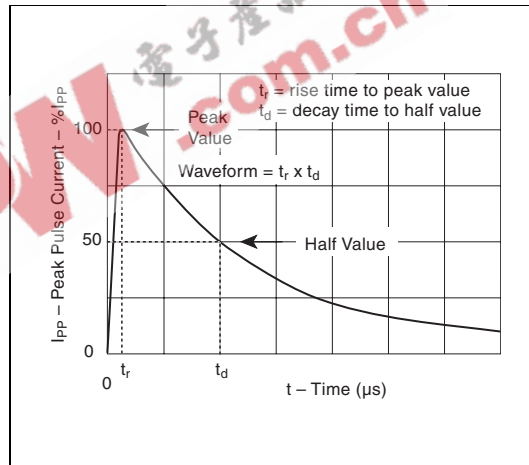

$t_r \times t_d$ Pulse Wave-form

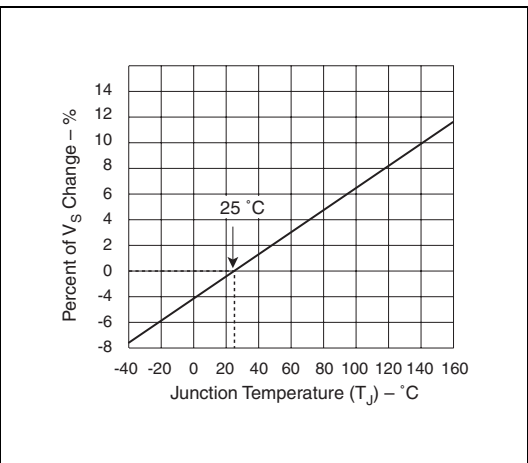

Normalized V_S Change versus Junction Temperature

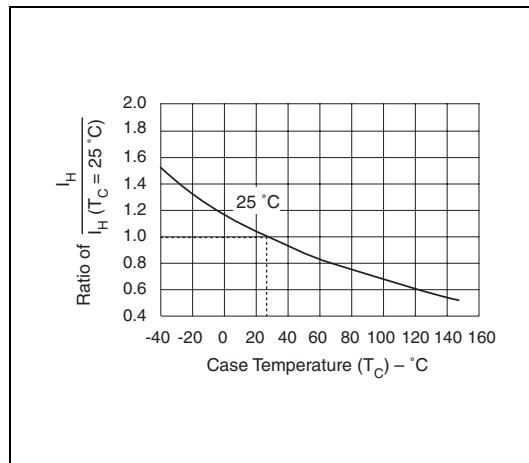

Normalized DC Holding Current versus Case Temperature

SIDACtor Device



TO-92 *SIDACtor* solid state protection devices protect telecommunications equipment such as modems, line cards, fax machines, and other CPE.

SIDACtor devices are used to enable equipment to meet various regulatory requirements including GR 1089, ITU K.20, K.21, and K.45, IEC 60950, UL 60950, and TIA-968 (formerly known as FCC Part 68)

Electrical Parameters

Part Number *	V _{DRM} Volts	V _S Volts	V _T Volts	I _{DRM} μ Amps	I _S mAmps	I _T Amps	I _H mAmps	C _o pF
P0080E_	6	25	4	5	800	2.2	50	100
P0300E_	25	40	4	5	800	2.2	50	110
P0640E_	58	77	4	5	800	2.2	150	50
P0720E_	65	88	4	5	800	2.2	150	50
P0900E_	75	98	4	5	800	2.2	150	50
P1100E_	90	130	4	5	800	2.2	150	40
P1300E_	120	160	4	5	800	2.2	150	40
P1500E_	140	180	4	5	800	2.2	150	40
P1800E_	170	220	4	5	800	2.2	150	30
P2300E_	190	260	4	5	800	2.2	150	30
P2600E_	220	300	4	5	800	2.2	150	30
P3100E_	275	350	4	5	800	2.2	150	30
P3500E_	320	400	4	5	800	2.2	150	30

* For individual "EA", "EB", and "EC" surge ratings, see table below.

General Notes:

- All measurements are made at an ambient temperature of 25 °C. I_{PP} applies to -40 °C through +85 °C temperature range.
- I_{PP} is a repetitive surge rating and is guaranteed for the life of the product.
- Listed *SIDACtor* devices are bi-directional. All electrical parameters and surge ratings apply to forward and reverse polarities.
- V_{DRM} is measured at I_{DRM}.
- V_S is measured at 100 V/ μ s.
- Special voltage (V_S and V_{DRM}) and holding current (I_H) requirements are available upon request.
- Off-state capacitance is measured at 1 MHz with a 2 V bias and is a typical value for "EA" and "EB" product. "EC" capacitance is approximately 2x the listed value. The off-state capacitance of the P0080EB is equal to the "EC" device.

Surge Ratings

Series	I _{PP} 2x10 μ s Amps	I _{PP} 8x20 μ s Amps	I _{PP} 10x160 μ s Amps	I _{PP} 10x560 μ s Amps	I _{PP} 10x1000 μ s Amps	I _{TSM} 60 Hz Amps	di/dt Amps/ μ s
A	150	150	90	50	45	20	500
B	250	250	150	100	80	30	500
C	500	400	200	150	100	50	500

Thermal Considerations

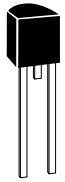
Package	Symbol	Parameter	Value	Unit
	T_J	Operating Junction Temperature Range	-40 to +150	$^{\circ}\text{C}$
	T_S	Storage Temperature Range	-65 to +150	$^{\circ}\text{C}$
	$R_{\theta JA}$	Thermal Resistance: Junction to Ambient	90	$^{\circ}\text{C/W}$

Data Sheets

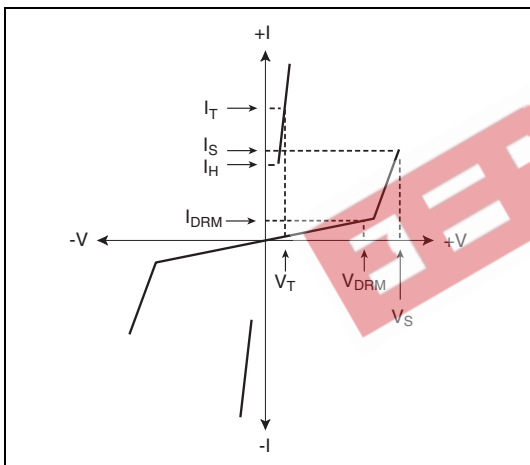

V-I Characteristics

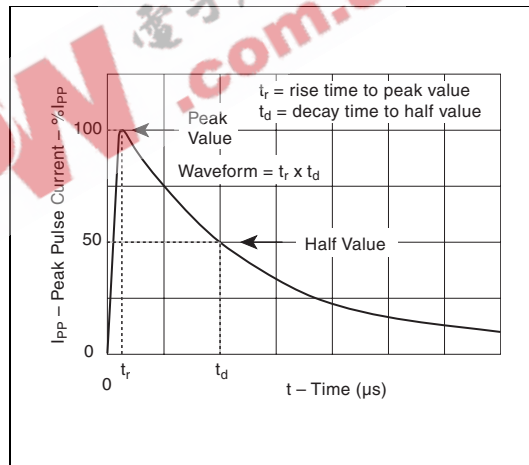

$t_r \times t_d$ Pulse Wave-form

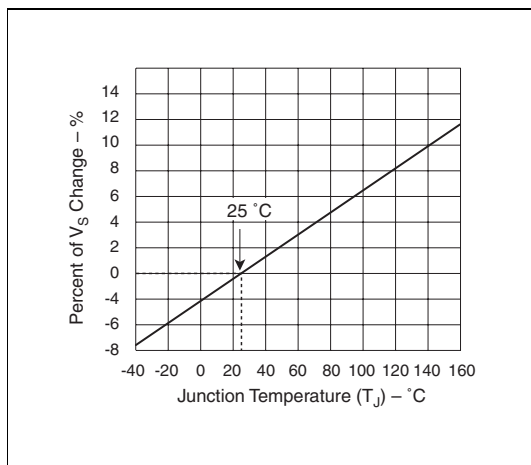

Normalized V_S Change versus Junction Temperature

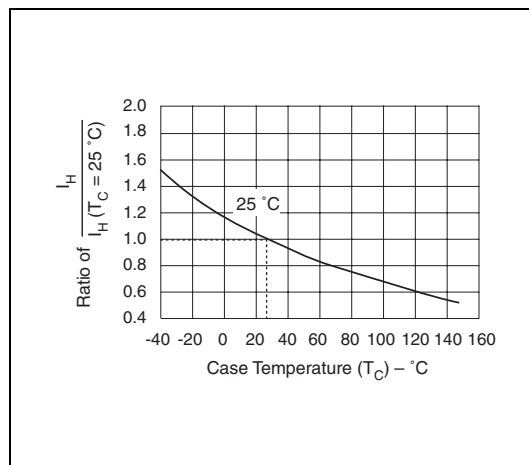

Normalized DC Holding Current versus Case Temperature

MicroCapacitance (MC) SIDACtor Device



The TO-92 MC SIDACtor series is intended for applications sensitive to load values. Typically, high speed connections require a lower capacitance. C_o values for MC devices are 40% lower than a standard EC part.

This MC SIDACtor series is used to enable equipment to meet various regulatory requirements including GR 1089, ITU K.20, K.21, and K.45, IEC 60950, UL 60950, and TIA-968 (formerly known as FCC Part 68) without the need of series resistors.

Electrical Parameters

Part Number *	V_{DRM} Volts	V_S Volts	V_T Volts	I_{DRM} μ Amps	I_S mAmps	I_T Amps	I_H mAmps	C_o pF
P0640EC MC	58	77	4	5	800	2.2	150	60
P1500EC MC	140	180	4	5	800	2.2	150	50
P2600EC MC	220	300	4	5	800	2.2	150	40
P3100EC MC	275	350	4	5	800	2.2	150	40

* For surge ratings, see table below.

General Notes:

- All measurements are made at an ambient temperature of 25 °C. I_{PP} applies to -40 °C through +85 °C temperature range.
- I_{PP} is a repetitive surge rating and is guaranteed for the life of the product.
- Listed SIDACtor devices are bi-directional. All electrical parameters and surge ratings apply to forward and reverse polarities.
- V_{DRM} is measured at I_{DRM} .
- V_S is measured at 100 V/ μ s.
- Special voltage (V_S and V_{DRM}) and holding current (I_H) requirements are available upon request.
- Off-state capacitance is measured at 1 MHz with a 2 V bias.

Surge Ratings

Series	I_{PP} 2x10 μ s Amps	I_{PP} 8x20 μ s Amps	I_{PP} 10x160 μ s Amps	I_{PP} 10x560 μ s Amps	I_{PP} 10x1000 μ s Amps	I_{TSM} 60 Hz Amps	di/dt Amps/ μ s
C	500	400	200	150	100	50	500

Thermal Considerations

Package	Symbol	Parameter	Value	Unit
	T_J	Operating Junction Temperature Range	-40 to +150	$^{\circ}\text{C}$
	T_S	Storage Temperature Range	-65 to +150	$^{\circ}\text{C}$
	$R_{\theta JA}$	Thermal Resistance: Junction to Ambient	90	$^{\circ}\text{C/W}$

Data Sheets

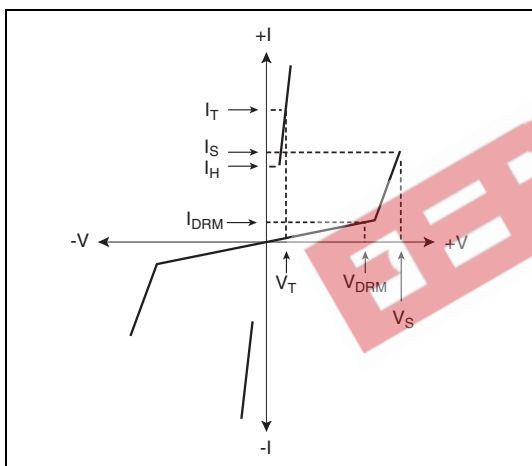

V-I Characteristics

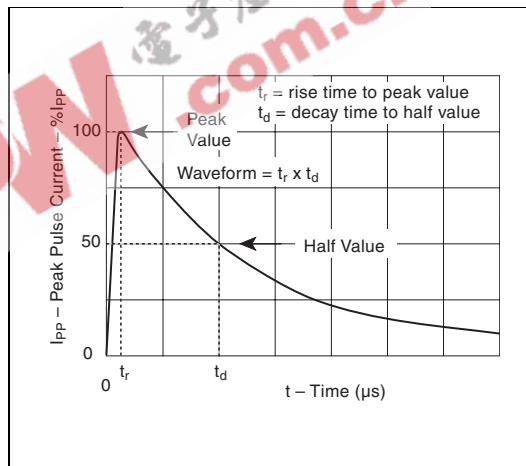

$t_r \times t_d$ Pulse Wave-form

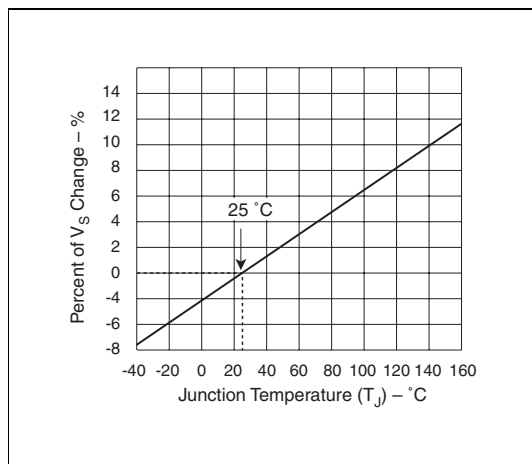

Normalized V_S Change versus Junction Temperature

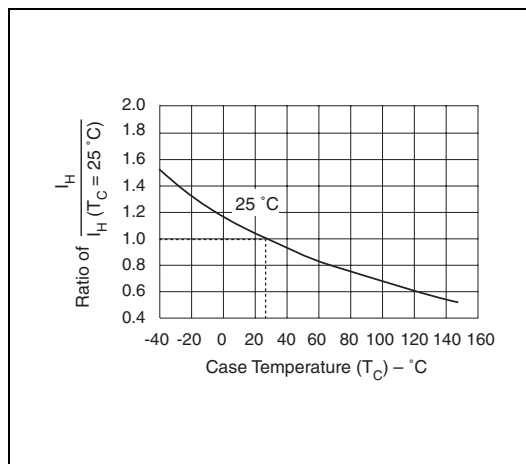

Normalized DC Holding Current versus Case Temperature

Balanced Three-chip SIDACtor Device

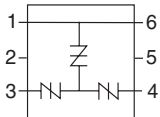

This balanced protector is a surface mount alternative to the modified TO-220 package. Based on a six-pin surface mount SOIC package, it uses Teccor's patented "Y" (US Patent 4,905,119) configuration. It is available in surge current ratings up to 500 A.

SIDACtor devices are used to enable equipment to meet various regulatory requirements including GR 1089, ITU K.20, K.21, and K.45, IEC 60950, UL 60950, and TIA-968 (formerly known as FCC Part 68).

Electrical Parameters

Part Number *	V _{DRM} Volts	V _S Volts	V _{DRM} Volts	V _S Volts	V _T Volts	I _{DRM} μ Amps	I _S mAmps	I _T Amps	I _H mAmps	C _O pF
	Pins 1-3, 1-4		Pins 3-4							
P1553U_	130	180	130	180	8	5	800	2.2	150	40
P1803U_	150	210	150	210	8	5	800	2.2	150	40
P2103U_	170	250	170	250	8	5	800	2.2	150	40
P2353U_	200	270	200	270	8	5	800	2.2	150	40
P2703U_	230	300	230	300	8	5	800	2.2	150	30
P3203U_	270	350	270	350	8	5	800	2.2	150	30
P3403U_	300	400	300	400	8	5	800	2.2	150	30
P5103U_	420	600	420	600	8	5	800	2.2	150	30
A2106U_3 **	170	250	50	80	8	5	800	2.2	120	40
A5030U_3 **	400	550	270	350	8	5	800	2.2	150	30

* For individual "UA", "UB", and "UC" surge ratings, see table below.

** Asymmetrical

General Notes:

- All measurements are made at an ambient temperature of 25 °C. I_{PP} applies to -40 °C through +85 °C temperature range.
- I_{PP} is a repetitive surge rating and is guaranteed for the life of the product.
- Listed SIDACtor devices are bi-directional. All electrical parameters and surge ratings apply to forward and reverse polarities.
- V_{DRM} is measured at I_{DRM}.
- V_S is measured at 100 V/ μ s.
- Special voltage (V_S and V_{DRM}) and holding current (I_H) requirements are available upon request.
- Off-state capacitance is measured between Pins 1-3 and 1-4 at 1 MHz with a 2 V bias and is a typical value for "UA" product. "UB" and "UC" capacitance is approximately 2x higher.
- Device is designed to meet balance requirements of GTS 8700 and GR 974.

Surge Ratings

Series	I _{PP} 2x10 μ s Amps	I _{PP} 8x20 μ s Amps	I _{PP} 10x160 μ s Amps	I _{PP} 10x560 μ s Amps	I _{PP} 10x1000 μ s Amps	I _{TSM} 60 Hz Amps	di/dt Amps/ μ s
A	150	150	90	50	45	20	500
B	250	250	150	100	80	30	500
C	500	400	200	150	100	50	500

Thermal Considerations

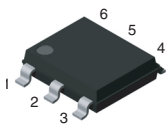
Package	Symbol	Parameter	Value	Unit
	T_J	Operating Junction Temperature Range	-40 to +125	$^{\circ}\text{C}$
	T_S	Storage Temperature Range	-65 to +150	$^{\circ}\text{C}$
	$R_{\theta JA}$	Thermal Resistance: Junction to Ambient	60	$^{\circ}\text{C/W}$

Data Sheets

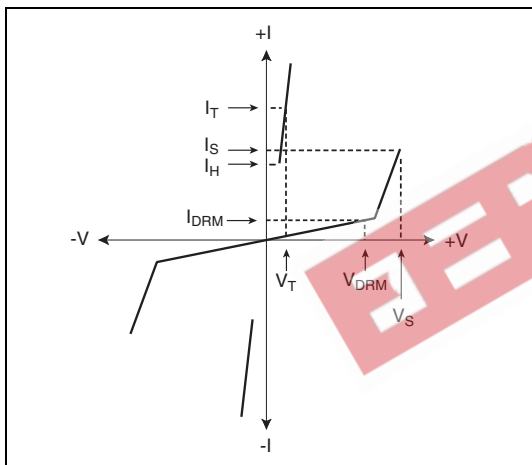

V-I Characteristics

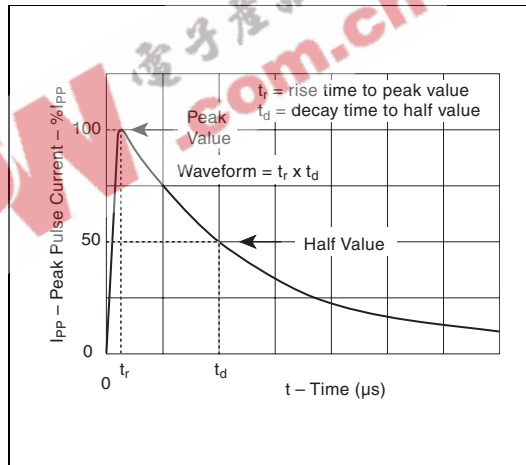

$t_r \times t_d$ Pulse Wave-form

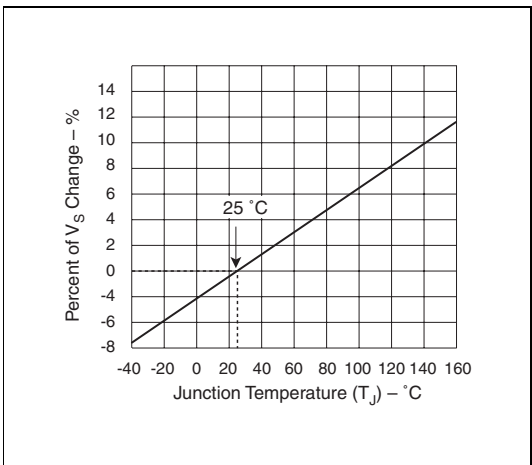

Normalized V_S Change versus Junction Temperature

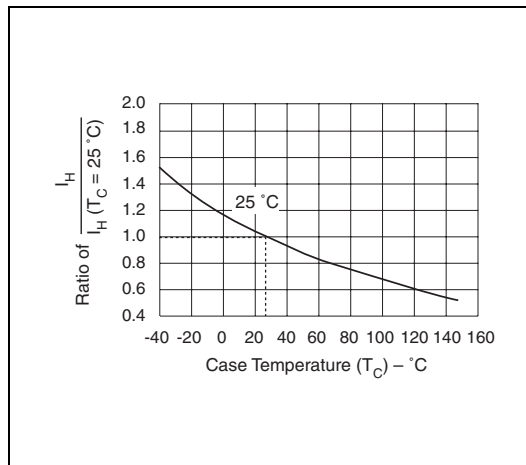

Normalized DC Holding Current versus Case Temperature

Multiport SIDACtor Device

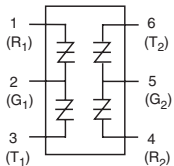

The multiport line protector is an integrated multichip solution for protecting multiple twisted pair from overvoltage conditions. Based on a six-pin surface mount SOIC package, it is equivalent to four discrete DO-214AA or two TO-220 packages. Available in surge current ratings up to 500 A, the multiport line protector is ideal for densely populated, high-speed line cards that cannot afford PCB inefficiencies or the use of series power resistors.

SIDACtor devices are used to enable equipment to meet various regulatory requirements including GR 1089, ITU K.20, K.21, and K.45, IEC 60950, UL 60950, and TIA-968 (formerly known as FCC Part 68).

Electrical Parameters

Part Number *	V _{DRM} Volts	V _S Volts	V _{DRM} Volts	V _S Volts	V _T Volts	I _{DRM} μ Amps	I _S mAmps	I _T Amps	I _H mAmps	C _O pF
	Pins 1-2, 3-2, 4-5, 6-5		Pins 1-3, 4-6							
P0084U_	6	25	12	50	4	5	800	2.2	50	100
P0304U_	25	40	50	80	4	5	800	2.2	50	110
P0644U_	58	77	116	154	4	5	800	2.2	150	50
P0724U_	65	88	130	176	4	5	800	2.2	150	50
P0904U_	75	98	150	196	4	5	800	2.2	150	50
P1104U_	90	130	180	260	4	5	800	2.2	150	40
P1304U_	120	160	240	320	4	5	800	2.2	150	40
P1504U_	140	180	280	360	4	5	800	2.2	150	40
P1804U_	170	220	340	440	4	5	800	2.2	150	30
P2304U_	190	260	380	520	4	5	800	2.2	150	30
P2604U_	220	300	440	600	4	5	800	2.2	150	30
P3104U_	275	350	550	700	4	5	800	2.2	150	30
P3504U_	320	400	640	800	4	5	800	2.2	150	30

* For individual "UA", "UB", and "UC" surge ratings, see table below.

General Notes:

- All measurements are made at an ambient temperature of 25 °C. I_{PP} applies to -40 °C through +85 °C temperature range.
- I_{PP} is a repetitive surge rating and is guaranteed for the life of the product.
- Listed SIDACtor devices are bi-directional. All electrical parameters and surge ratings apply to forward and reverse polarities.
- V_{DRM} is measured at I_{DRM}, and V_S is measured at 100 V/ μ s.
- Off-state capacitance is measured between Pins 1-2 and 3-2 at 1 MHz with a 2 V bias and is a typical value for "UA" product. "UB" and "UC" capacitance is approximately 2x higher.

Surge Ratings

Series	I _{PP} 2x10 μ s Amps	I _{PP} 8x20 μ s Amps	I _{PP} 10x160 μ s Amps	I _{PP} 10x560 μ s Amps	I _{PP} 10x1000 μ s Amps	I _{TSM} 60 Hz Amps	di/dt Amps/ μ s
A	150	150	90	50	45	20	500
B	250	250	150	100	80	30	500
C	500	400	200	150	100	50	500

Thermal Considerations

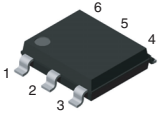
Package	Symbol	Parameter	Value	Unit
	T_J	Operating Junction Temperature Range	-40 to +150	$^{\circ}\text{C}$
	T_S	Storage Temperature Range	-65 to +150	$^{\circ}\text{C}$
	$R_{\theta JA}$	Thermal Resistance: Junction to Ambient	60	$^{\circ}\text{C/W}$

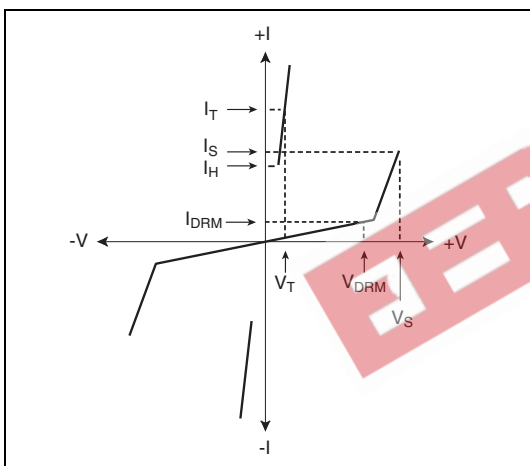

V-I Characteristics

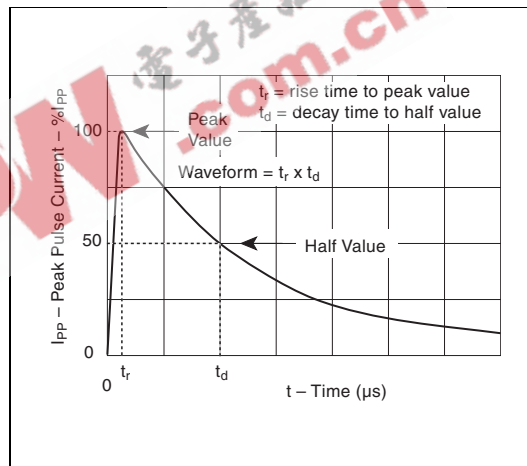

$t_r \times t_d$ Pulse Wave-form

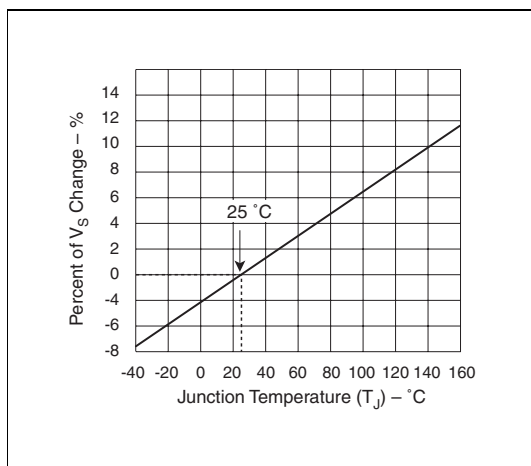

Normalized V_S Change versus Junction Temperature

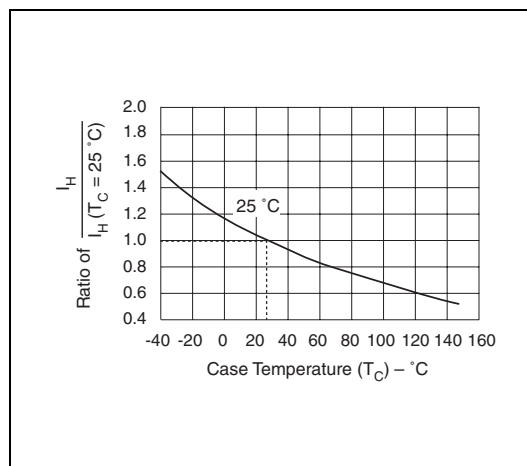

Normalized DC Holding Current versus Case Temperature

Data Sheets

Multiport Balanced SIDACtor Device

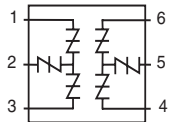

This multiport balanced protector is a surface mount alternative to the modified TO-220 package. It is based on a six-pin surface mount SOIC package and uses Teccor's patented "Y" (US Patent 4,905,119) configuration. It is available in surge current ratings up to 500 A.

SIDACtor devices are used to enable equipment to meet various regulatory requirements including GR 1089, ITU K.20, K.21, and K.45, IEC 60950, UL 60950, and TIA-968 (formerly known as FCC Part 68).

Electrical Parameters — Symmetrical

Part Number *	V _{DRM} Volts	V _S Volts	V _{DRM} Volt	V _S Volts	V _T Volts	I _{DRM} μ Amps	I _S mAmps	I _T Amps	I _H mAmps	C _O pF
	Pins 1-2, 2-3, 1-3	Pins 4-5, 5-6, 4-6	Pins 3-2, 6-5, 1-2, 4-5							
P1556U_	130	180	130	180	8	5	800	2.2	150	50
P1806U_	150	210	150	210	8	5	800	2.2	150	50
P2106U_	170	250	170	250	8	5	800	2.2	150	40
P2356U_	200	270	200	270	8	5	800	2.2	150	40
P2706U_	230	300	230	300	8	5	800	2.2	150	40
P3206U_	270	350	270	350	8	5	800	2.2	150	40
P3406U_	300	400	300	400	8	5	800	2.2	150	40
P5106U_	420	600	420	600	8	5	800	2.2	150	40

Electrical Parameters — Asymmetrical

Part Number *	V _{DRM} Volts	V _S Volts	V _{DRM} Volt	V _S Volts	V _T Volts	I _{DRM} μ Amps	I _S mAmps	I _T Amps	I _H mAmps	C _O pF
	Pins 1-2, 2-3, 4-5, 5-6	Pins 4-6, 1-3								
A2106U_6	170	250	50	80	3.5	5	800	2.2	120	40
A5030U_6	400	550	270	350	3.5	5	800	2.2	150	30

* For individual "UA", "UB", and "UC" surge ratings, see table below.

General Notes:

- All measurements are made at an ambient temperature of 25 °C. I_{PP} applies to -40 °C through +85 °C temperature range.
- I_{PP} is a repetitive surge rating and is guaranteed for the life of the product.
- Listed SIDACtor devices are bi-directional. All electrical parameters and surge ratings apply to forward and reverse polarities.
- V_{DRM} is measured at I_{DRM}.
- V_S is measured at 100 V/ μ s.
- Special voltage (V_S and V_{DRM}) and holding current (I_H) requirements are available upon request.
- Off-state capacitance is measured between Pins 1-2 and 3-2 at 1 MHz with a 2 V bias and is a typical value for "UA" product. "UB" and "UC" capacitance is approximately 10 pF higher.
- Device is designed to meet balance requirements of GTS 8700 and GR 974.

Surge Ratings

Series	I _{PP} 2x10 μ s Amps	I _{PP} 8x20 μ s Amps	I _{PP} 10x160 μ s Amps	I _{PP} 10x560 μ s Amps	I _{PP} 10x1000 μ s Amps	I _{TSM} 60 Hz Amps	di/dt Amps/ μ s
A	150	150	90	50	45	20	500
B	250	250	150	100	80	30	500
C	500	400	200	150	100	50	500

Thermal Considerations

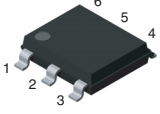
Package	Symbol	Parameter	Value	Unit
	T_J	Operating Junction Temperature Range	-40 to +125	$^{\circ}\text{C}$
	T_S	Storage Temperature Range	-65 to +150	$^{\circ}\text{C}$
	$R_{\theta JA}$	Thermal Resistance: Junction to Ambient	60	$^{\circ}\text{C}/\text{W}$

Data Sheets

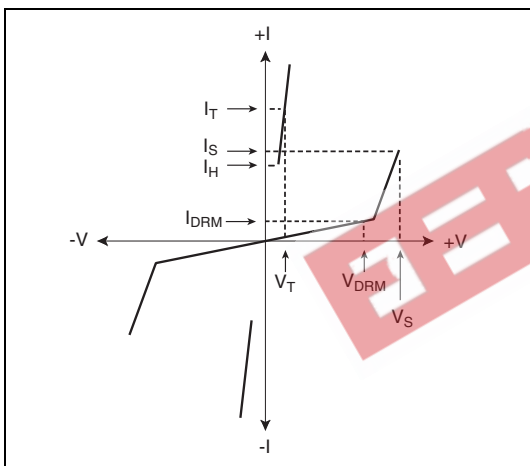

V-I Characteristics

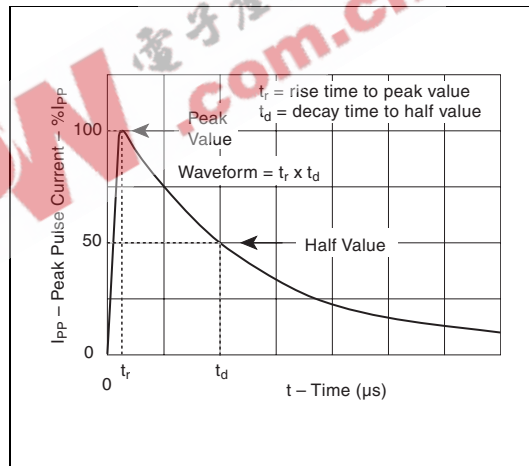

$t_r \times t_d$ Pulse Wave-form

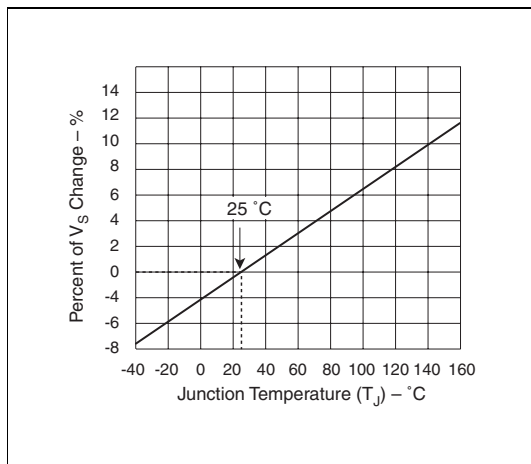

Normalized V_S Change versus Junction Temperature

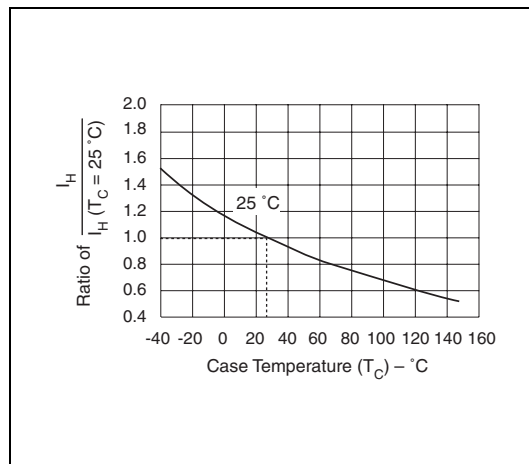

Normalized DC Holding Current versus Case Temperature

SIDACtor Device



The modified TO-220 Type 61 *SIDACtor* solid state protection device can be used in telecommunication protection applications that do not reference earth ground.

SIDACtor devices are used to enable equipment to meet various regulatory requirements including GR 1089, ITU K.20, K.21 and K.45, IEC 60950, UL 60950, and TIA-968 (formerly known as FCC Part 68).

Electrical Parameters

Part Number *	V _{DRM} Volts	V _S Volts	V _T Volts	I _{DRM} μ Amps	I _S mAmps	I _T Amps	I _H mAmps	C _o pF
P2000AA61	180	220	4	5	800	2.2	150	30
P2200AA61	200	240	4	5	800	2.2	150	30
P2400AA61	220	260	4	5	800	2.2	150	30
P2500AA61	240	290	4	5	800	2.2	150	30
P3000AA61	270	330	4	5	800	2.2	150	30
P3300AA61	300	360	4	5	800	2.2	150	30

* For surge ratings, see table below.

General Notes:

- All measurements are made at an ambient temperature of 25 °C. I_{PP} applies to -40 °C through +85 °C temperature range.
- I_{PP} is a repetitive surge rating and is guaranteed for the life of the product.
- Listed *SIDACtor* devices are bi-directional. All electrical parameters and surge ratings apply to forward and reverse polarities.
- V_{DRM} is measured at I_{DRM}.
- V_S is measured at 100 V/ μ s.
- Special voltage (V_S and V_{DRM}) and holding current (I_H) requirements are available upon request.
- Off-state capacitance is measured at 1 MHz with a 2 V bias and is a typical value.

Surge Ratings

Series	I _{PP} 0.2x310 μ s Amps	I _{PP} 2x10 μ s Amps	I _{PP} 8x20 μ s Amps	I _{PP} 10x160 μ s Amps	I _{PP} 10x560 μ s Amps	I _{PP} 5x320 μ s Amps	I _{PP} 10x1000 μ s Amps	I _{TSM} 60 Hz Amps	di/dt Amps/ μ s
A	20	150	150	90	50	75	45	20	500

Thermal Considerations

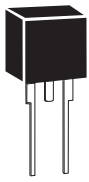
Package	Symbol	Parameter	Value	Unit
Modified TO-220 Type 61 	T_J	Operating Junction Temperature Range	-40 to +150	$^{\circ}\text{C}$
	T_S	Storage Temperature Range	-65 to +150	$^{\circ}\text{C}$
	$R_{\theta JA}$	Thermal Resistance: Junction to Ambient	50	$^{\circ}\text{C/W}$

Data Sheets

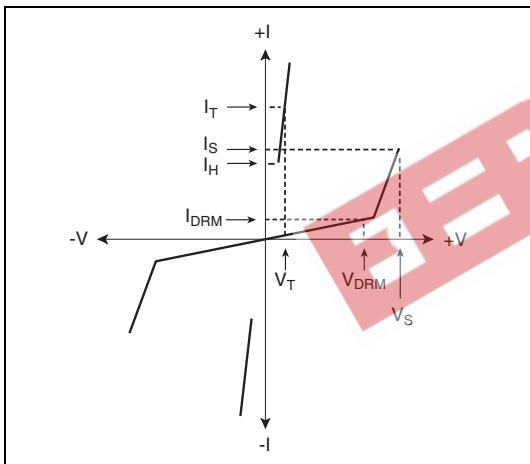

V-I Characteristics

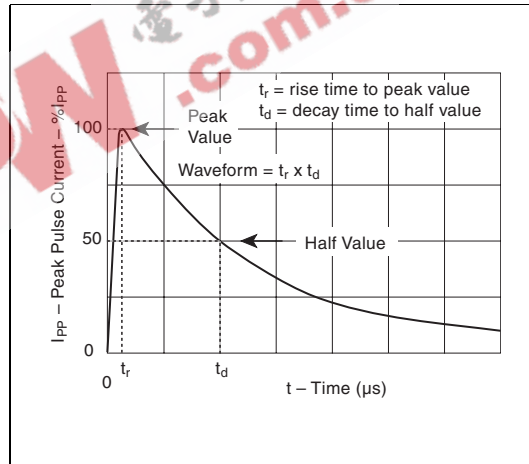

$t_r \times t_d$ Pulse Wave-form

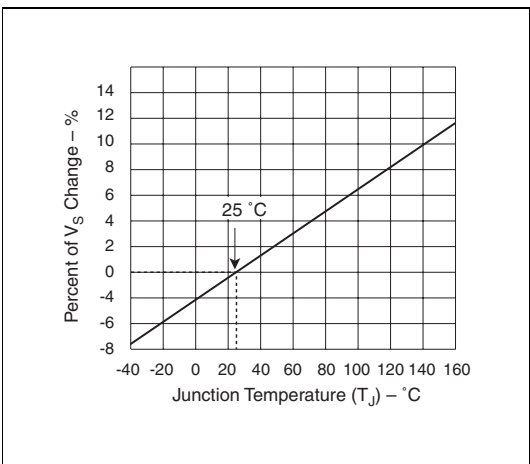

Normalized V_S Change versus Junction Temperature

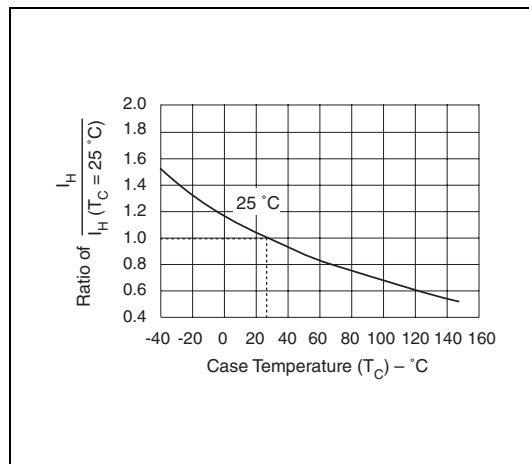

Normalized DC Holding Current versus Case Temperature

Two-chip SIDACTor Device

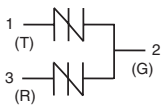

The two-chip modified TO-220 *SIDACTor* solid state device protects telecommunication equipment in applications that reference Tip and Ring to earth ground but do not require balanced protection.

SIDACTor devices are used to enable equipment to meet various regulatory requirements including GR 1089, ITU K.20, K.21 and K.45, IEC 60950, UL 60950, and TIA-968 (formerly known as FCC Part 68).

Electrical Parameters

Part Number *	V _{DRM} Volts	V _S Volts	V _{DRM} Volts	V _S Volts	V _T Volts	I _{DRM} μAmps	I _S mAmps	I _T Amps	I _H mAmps	C _o pF
	Pins 1-2, 3-2		Pins 1-3							
P0602A_	25	40	50	80	4	5	800	2.2	50	110
P1402A_	58	77	116	154	4	5	800	2.2	150	50
P1602A_	65	95	130	190	4	5	800	2.2	150	50
P2202A_	90	130	180	260	4	5	800	2.2	150	40
P2702A_	120	160	240	320	4	5	800	2.2	150	40
P3002A_	140	180	280	360	4	5	800	2.2	150	40
P3602A_	170	220	340	440	4	5	800	2.2	150	40
P4202A_	190	250	380	500	4	5	800	2.2	150	30
P4802A_	220	300	440	600	4	5	800	2.2	150	30
P6002A_	275	350	550	700	4	5	800	2.2	150	30

* For individual "AA", "AB", and "AC" surge ratings, see table below.

General Notes:

- All measurements are made at an ambient temperature of 25 °C. I_{PP} applies to -40 °C through +85 °C temperature range.
- I_{PP} is a repetitive surge rating and is guaranteed for the life of the product.
- Listed *SIDACTor* devices are bi-directional. All electrical parameters and surge ratings apply to forward and reverse polarities.
- V_{DRM} is measured at I_{DRM}.
- V_S is measured at 100 V/μs.
- Special voltage (V_S and V_{DRM}) and holding current (I_H) requirements are available upon request.
- Off-state capacitance is measured between Pins 1-2 and 3-2 at 1 MHz with a 2 V bias and is a typical value for "AA" and "AB" product. "AC" capacitance is approximately 2x the listed value.

Surge Ratings

Series	I _{PP} 2x10 μs Amps	I _{PP} 8x20 μs Amps	I _{PP} 10x160 μs Amps	I _{PP} 10x560 μs Amps	I _{PP} 10x1000 μs Amps	I _{TSM} 60 Hz Amps	di/dt Amps/μs
A	150	150	90	50	45	20	500
B	250	250	150	100	80	30	500
C	500	400	200	150	100	50	500

Thermal Considerations

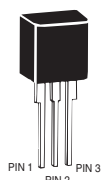
Package	Symbol	Parameter	Value	Unit
Modified TO-220 	T_J	Operating Junction Temperature Range	-40 to +150	$^{\circ}\text{C}$
	T_S	Storage Temperature Range	-65 to +150	$^{\circ}\text{C}$
	$R_{\theta JA}$	Thermal Resistance: Junction to Ambient	50	$^{\circ}\text{C}/\text{W}$

Data Sheets

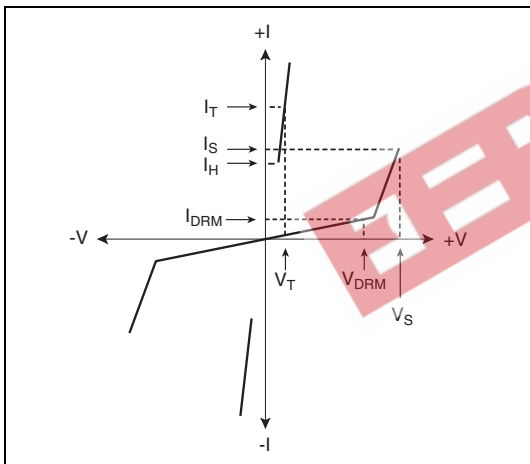

V-I Characteristics

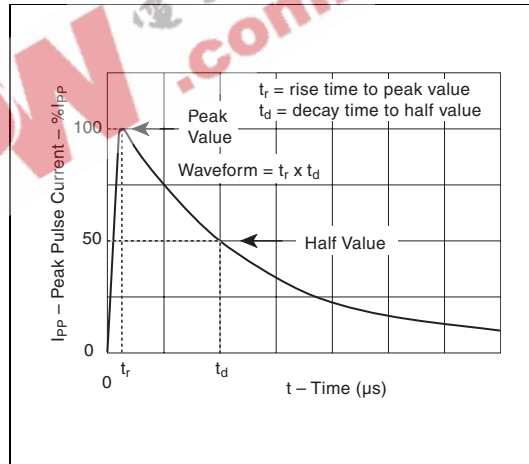

$t_r \times t_d$ Pulse Wave-form

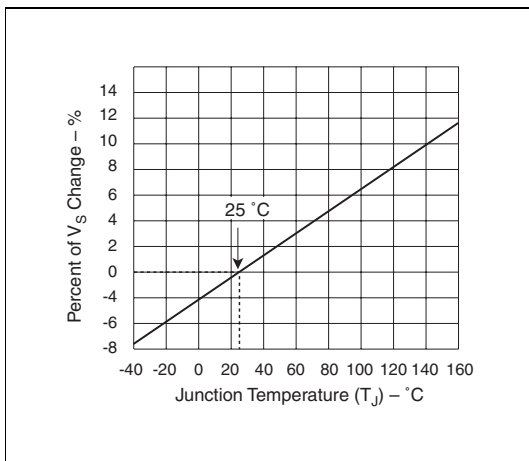

Normalized V_S Change versus Junction Temperature

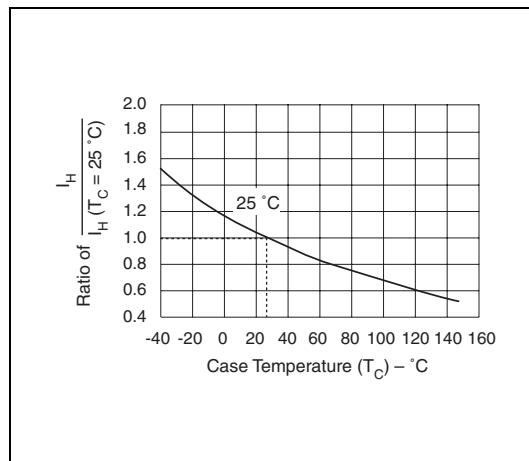

Normalized DC Holding Current versus Case Temperature

Two-chip MicroCapacitance (MC) SIDACtor Device

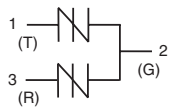

The two-chip modified TO-220 MC SIDACtor solid state device protects telecommunication equipment in applications that reference Tip and Ring to earth ground but do not require balanced protection.

SIDACtor devices are used to enable equipment to meet various regulatory requirements including GR 1089, ITU K.20, K.21 and K.45, IEC 60950, UL 60950, and TIA-968 (formerly known as FCC Part 68).

Electrical Parameters

Part Number *	V _{DRM} Volts	V _S Volts	V _{DRM} Volts	V _S Volts	V _T Volts	I _{DRM} μAmps	I _S mAmps	I _T Amps	I _H mAmps	C _O pF
	Pins 1-2, 3-2		Pins 1-3							
P0602AC MC	25	40	50	80	4	5	800	2.2	50	60
P1402AC MC	58	77	116	154	4	5	800	2.2	150	60
P1602AC MC	65	95	130	190	4	5	800	2.2	150	60
P2202AC MC	90	130	180	260	4	5	800	2.2	150	50
P2702AC MC	120	160	240	320	4	5	800	2.2	150	50
P3002AC MC	140	180	280	360	4	5	800	2.2	150	50
P3602AC MC	170	220	340	440	4	5	800	2.2	150	40
P4202AC MC	190	250	380	500	4	5	800	2.2	150	40
P4802AC MC	220	300	440	600	4	5	800	2.2	150	40
P6002AC MC	275	350	550	700	4	5	800	2.2	150	40

* For surge ratings, see table below.

General Notes:

- All measurements are made at an ambient temperature of 25 °C. I_{PP} applies to -40 °C through +85 °C temperature range.
- I_{PP} is a repetitive surge rating and is guaranteed for the life of the product.
- Listed SIDACtor devices are bi-directional. All electrical parameters and surge ratings apply to forward and reverse polarities.
- V_{DRM} is measured at I_{DRM}.
- V_S is measured at 100 V/μs.
- Special voltage (V_S and V_{DRM}) and holding current (I_H) requirements are available upon request.
- Off-state capacitance is measured between Pins 1-2 and 3-2 at 1 MHz with a 2 V bias.

Surge Ratings

Series	I _{PP} 2x10 μs Amps	I _{PP} 8x20 μs Amps	I _{PP} 10x160 μs Amps	I _{PP} 10x560 μs Amps	I _{PP} 10x1000 μs Amps	I _{TSM} 60 Hz Amps	di/dt Amps/μs
C	500	400	200	150	100	50	500

Thermal Considerations

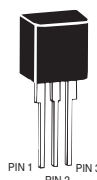
Package	Symbol	Parameter	Value	Unit
Modified TO-220 	T_J	Operating Junction Temperature Range	-40 to +150	$^{\circ}\text{C}$
	T_S	Storage Temperature Range	-65 to +150	$^{\circ}\text{C}$
	$R_{\theta JA}$	Thermal Resistance: Junction to Ambient	50	$^{\circ}\text{C/W}$

Data Sheets

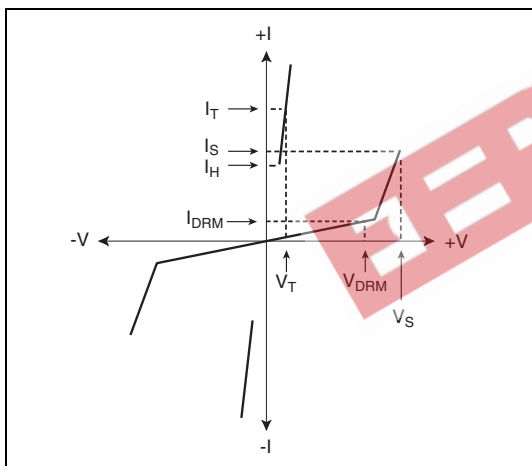

V-I Characteristics

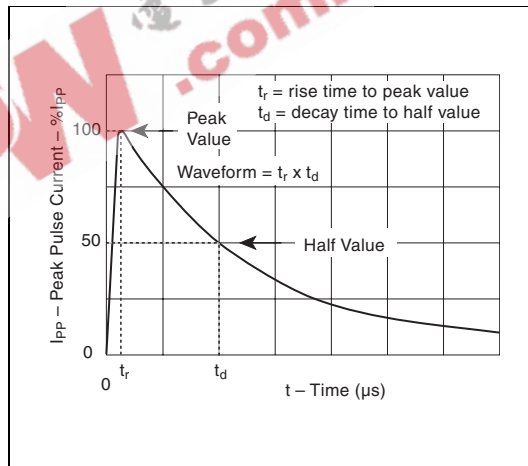

$t_r \times t_d$ Pulse Wave-form

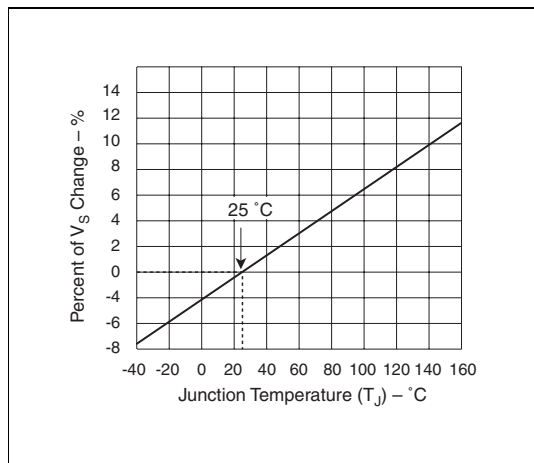

Normalized V_S Change versus Junction Temperature

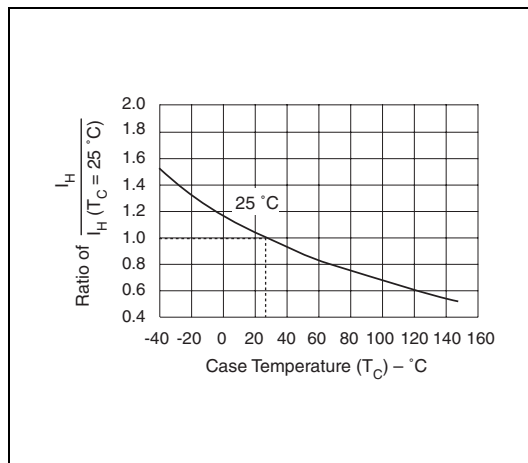

Normalized DC Holding Current versus Case Temperature

Balanced Three-chip SIDACtor Device

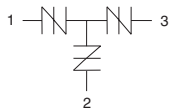

The three-chip modified TO-220 *SIDACtor* balanced solid state device is designed for telecommunication protection systems that reference Tip and Ring to earth ground. Applications include any piece of transmission equipment that requires balanced protection. This device is built using Teccor's patented "Y" (US Patent 4,905,119) configuration.

The *SIDACtor* device is used to enable equipment to meet various regulatory requirements including GR 1089, ITU K.20, K.21 and K.45, IEC 60950, UL 60950, and TIA-968 (formerly known as FCC Part 68).

Electrical Parameters

Part Number *	V _{DRM} Volts	V _S Volts	V _{DRM} Volts	V _S Volts	V _T Volts	I _{DRM} μ Amps	I _S mAmps	I _T Amps	I _H mAmps	C _O pF
	Pins 1-2, 2-3		Pins 1-3							
P1553A_	130	180	130	180	8	5	800	2.2	150	40
P1803A_	150	210	150	210	8	5	800	2.2	150	40
P2103A_	170	250	170	250	8	5	800	2.2	150	40
P2353A_	200	270	200	270	8	5	800	2.2	150	40
P2703A_	230	300	230	300	8	5	800	2.2	150	30
P3203A_	270	350	270	350	8	5	800	2.2	150	30
P3403A_	300	400	300	400	8	5	800	2.2	150	30
P5103A_	420	600	420	600	8	5	800	2.2	150	30
A2106A_3 **	170	250	50	80	8	5	800	2.2	120	40
A5030A_3 **	400	550	270	350	8	5	800	2.2	150	30

* For individual "AA", "AB", and "AC" surge ratings, see table below.

** Asymmetrical

General Notes:

- All measurements are made at an ambient temperature of 25 °C. I_{PP} applies to -40 °C through +85 °C temperature range.
- I_{PP} is a repetitive surge rating and is guaranteed for the life of the product.
- Listed *SIDACtor* devices are bi-directional. All electrical parameters and surge ratings apply to forward and reverse polarities.
- V_{DRM} is measured at I_{DRM}.
- V_S is measured at 100 V/ μ s.
- Special voltage (V_S and V_{DRM}) and holding current (I_H) requirements are available upon request.
- Off-state capacitance is measured between Pins 1-2 and 3-2 at 1 MHz with a 2 V bias and is a typical value for "AA" product. "AB" and "AC" capacitance is approximately 2x the listed value.
- Device is designed to meet balance requirements of GTS 8700 and GR 974.

Surge Ratings

Series	I _{PP} 2x10 μ s Amps	I _{PP} 8x20 μ s Amps	I _{PP} 10x160 μ s Amps	I _{PP} 10x560 μ s Amps	I _{PP} 10x1000 μ s Amps	I _{TSM} 60 Hz Amps	di/dt Amps/ μ s
A	150	150	90	50	45	20	500
B	250	250	150	100	80	30	500
C	500	400	200	150	100	50	500

Thermal Considerations

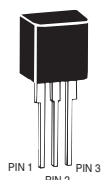
Package	Symbol	Parameter	Value	Unit
Modified TO-220 	T_J	Operating Junction Temperature Range	-40 to +150	$^{\circ}\text{C}$
	T_S	Storage Temperature Range	-65 to +150	$^{\circ}\text{C}$
	$R_{\theta JA}$	Thermal Resistance: Junction to Ambient	50	$^{\circ}\text{C/W}$

Data Sheets

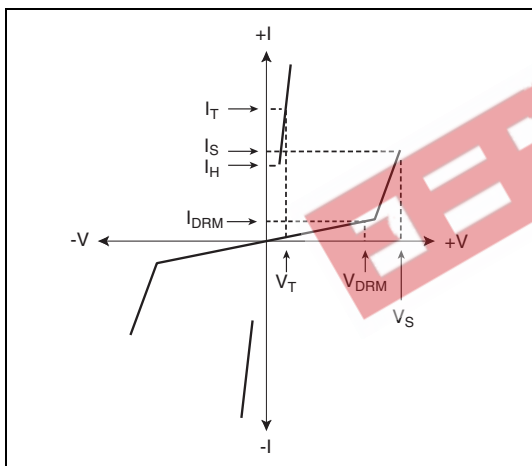

V-I Characteristics

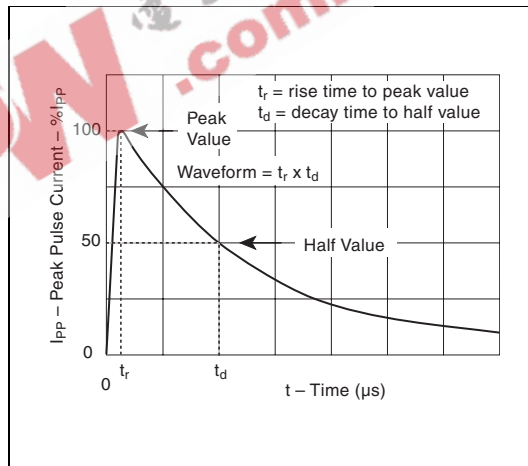

$t_r \times t_d$ Pulse Wave-form

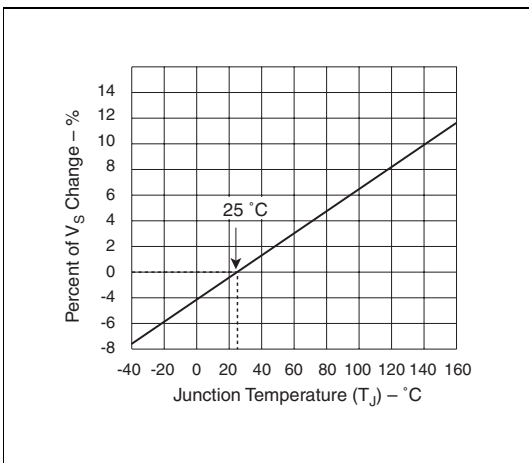

Normalized V_S Change versus Junction Temperature

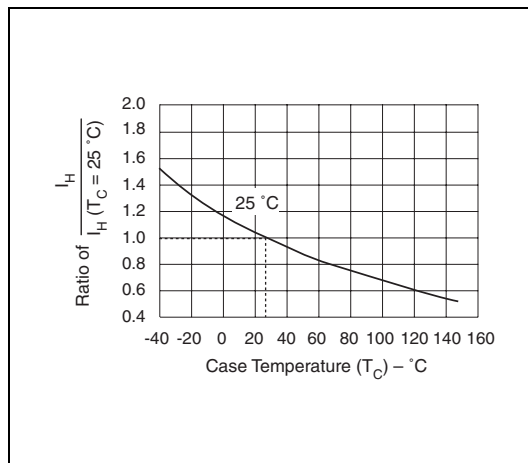

Normalized DC Holding Current versus Case Temperature

Balanced Three-chip MicroCapacitance (MC) SIDACtor Device

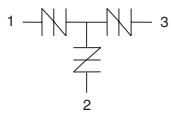

The balanced three-chip TO-220 MC SIDACtor solid state device protects telecommunication equipment in high-speed applications that are sensitive to load values and that require a lower capacitance. C_0 values for the MC are 40% lower than a standard AC part.

This MC SIDACtor series is used to enable equipment to meet various regulatory requirements including GR 1089, ITU K.20, K.21, and K.45, IEC 60950, UL 60950, and TIA-968 (formerly known as FCC Part 68) without the need of series resistors.

Electrical Parameters

Part Number *	V _{DRM} Volts	V _S Volts	V _{DRM} Volts	V _S Volts	V _T Volts	I _{DRM} μ Amps	I _S mAmps	I _T Amps	I _H mAmps	C ₀ pF
	Pins 1-2, 2-3		Pins 1-3							
P1553AC MC	130	180	130	180	8	5	800	2.2	150	40
P1803AC MC	150	210	150	210	8	5	800	2.2	150	40
P2103AC MC	170	250	170	250	8	5	800	2.2	150	40
P2353AC MC	200	270	200	270	8	5	800	2.2	150	40
P2703AC MC	230	300	230	300	8	5	800	2.2	150	30
P3203AC MC	270	350	270	350	8	5	800	2.2	150	30
P3403AC MC	300	400	300	400	8	5	800	2.2	150	30
P5103AC MC	420	600	420	600	8	5	800	2.2	150	30

* For surge ratings, see table below.

General Notes:

- All measurements are made at an ambient temperature of 25 °C. I_{PP} applies to -40 °C through +85 °C temperature range.
- I_{PP} is a repetitive surge rating and is guaranteed for the life of the product.
- Listed SIDACtor devices are bi-directional. All electrical parameters and surge ratings apply to forward and reverse polarities.
- V_{DRM} is measured at I_{DRM}.
- V_S is measured at 100 V/ μ s.
- Special voltage (V_S and V_{DRM}) and holding current (I_H) requirements are available upon request.
- Off-state capacitance is measured between Pins 1-2 and 3-2 at 1 MHz with a 2 V bias.
- Device is designed to meet balance requirements of GTS 8700 and GR 974.

Surge Ratings

Series	I _{PP} 2x10 μ s Amps	I _{PP} 8x20 μ s Amps	I _{PP} 10x160 μ s Amps	I _{PP} 10x560 μ s Amps	I _{PP} 10x1000 μ s Amps	I _{TSM} 60 Hz Amps	di/dt Amps/ μ s
C	500	400	200	150	100	50	500

Thermal Considerations

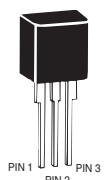
Package	Symbol	Parameter	Value	Unit
Modified TO-220 	T_J	Operating Junction Temperature Range	-40 to +150	$^{\circ}\text{C}$
	T_S	Storage Temperature Range	-65 to +150	$^{\circ}\text{C}$
	$R_{\theta JA}$	Thermal Resistance: Junction to Ambient	50	$^{\circ}\text{C/W}$

Data Sheets

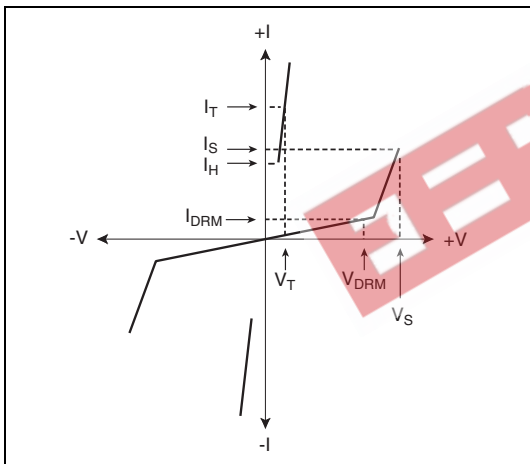

V-I Characteristics

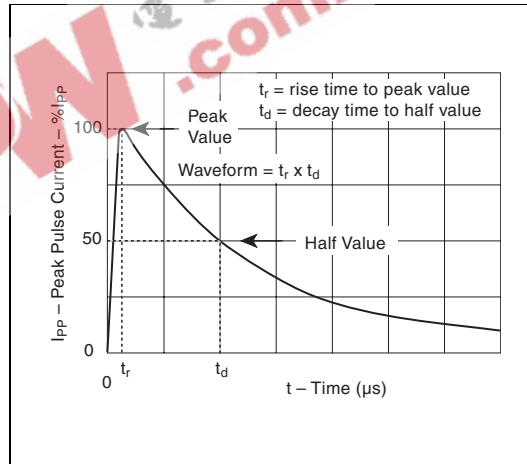

$t_r \times t_d$ Pulse Wave-form

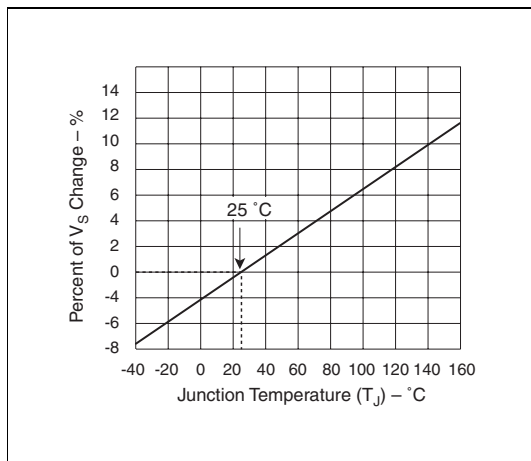

Normalized V_S Change versus Junction Temperature

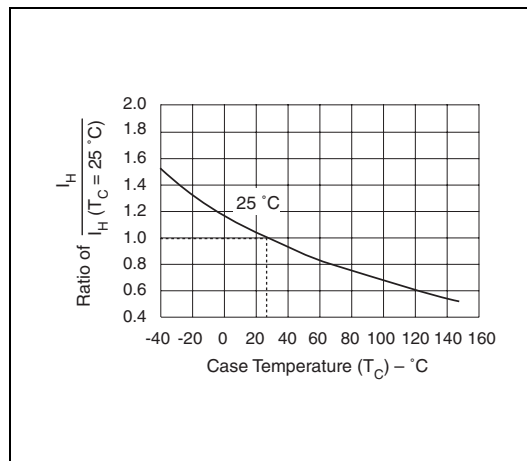

Normalized DC Holding Current versus Case Temperature

LCAS Asymmetrical Multiport Device

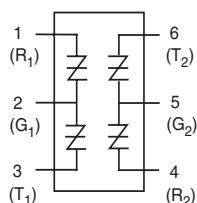

This is an integrated multichip solution for protecting multiple twisted pair from overvoltage conditions. Based on a six-pin surface mount SOIC package, it is equivalent to four discrete DO-214AA or two TO-220 packages. Available in surge current ratings up to 500 A, the multiport line protector is ideal for densely populated line cards that cannot afford PCB inefficiencies or the use of series power resistors.

For a diagram of an LCAS (Line Circuit Access Switch) application, see Figure 3.21.

Electrical Parameters

Part Number *	V _{DRM} Volts	V _S Volts	V _{DRM} Volts	V _S Volts	V _T Volts	I _{DRM} μAmps	I _S mAmps	I _T Amps	I _H mAmps	C _O pF
	Pins 3-2, 6-5		Pins 1-2, 4-5							
A1220U_4	100	130	180	220	4	5	800	2.2	120	30
A1225U_4	100	130	230	290	4	5	800	2.2	120	30

* For individual "UA", "UB", and "UC" surge ratings, see table below.

General Notes:

- All measurements are made at an ambient temperature of 25 °C. I_{PP} applies to -40 °C through +85 °C temperature range.
- I_{PP} is a repetitive surge rating and is guaranteed for the life of the product.
- Listed *SIDACTor* devices are bi-directional. All electrical parameters and surge ratings apply to forward and reverse polarities.
- V_{DRM} is measured at I_{DRM}.
- V_S is measured at 100 V/μs.
- Special voltage (V_S and V_{DRM}) and holding current (I_H) requirements are available upon request.
- Off-state capacitance is measured between Pins 1-2 and 3-2 at 1 MHz with a 2 V bias and is a typical value for "UA" product. "UB" and "UC" capacitance is approximately 2x higher.

Surge Ratings

Series	I _{PP} 2x10 μs Amps	I _{PP} 8x20 μs Amps	I _{PP} 10x160 μs Amps	I _{PP} 10x560 μs Amps	I _{PP} 10x1000 μs Amps	I _{TSM} 60 Hz Amps	di/dt Amps/μs
A	150	150	90	50	45	20	500
B	250	250	150	100	80	30	500
C	500	400	200	150	100	50	500

Thermal Considerations

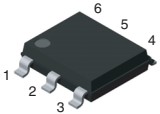
Package	Symbol	Parameter	Value	Unit
	T_J	Operating Junction Temperature Range	-40 to +125	$^{\circ}\text{C}$
	T_S	Storage Temperature Range	-65 to +150	$^{\circ}\text{C}$
	$R_{\theta JA}$	Thermal Resistance: Junction to Ambient	60	$^{\circ}\text{C/W}$

Data Sheets

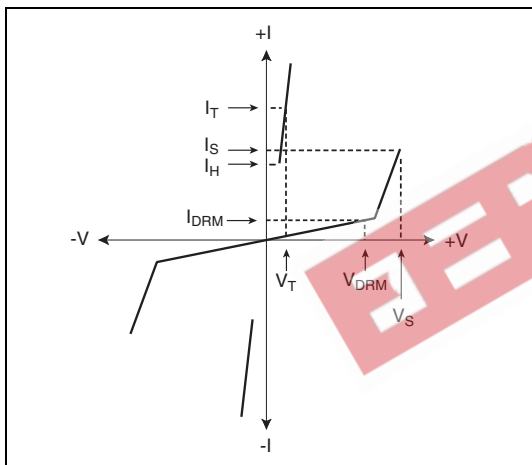

V-I Characteristics

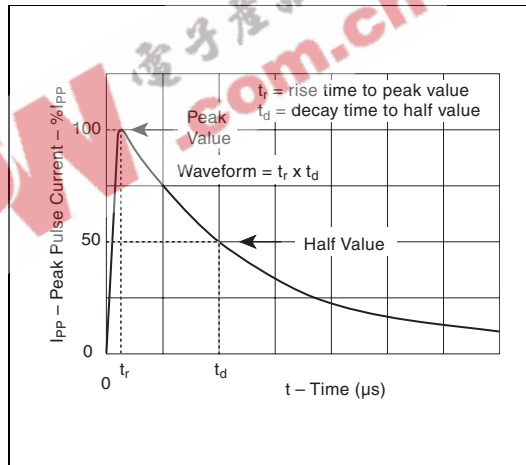

$t_r \times t_d$ Pulse Wave-form

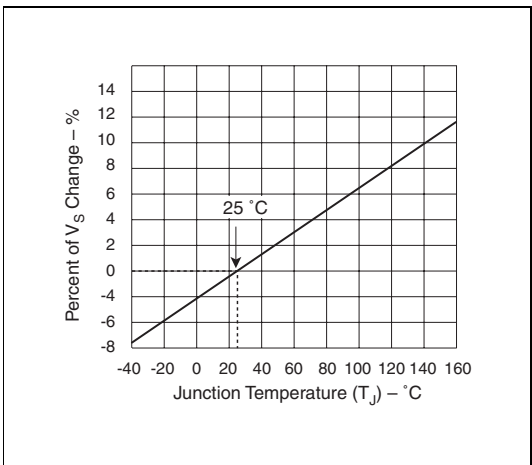

Normalized V_S Change versus Junction Temperature

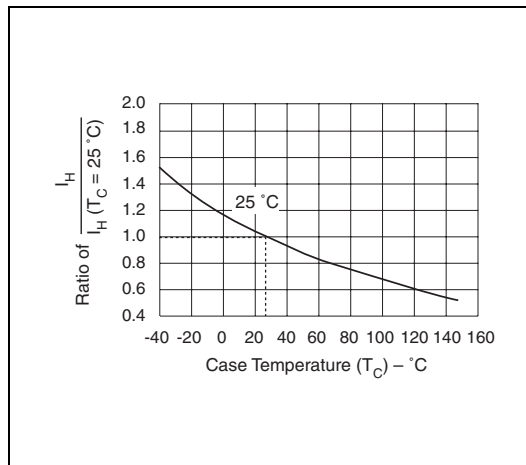

Normalized DC Holding Current versus Case Temperature

LCAS Asymmetrical Discrete Device



These DO-214AA *SIDACTor* devices are intended for LCAS (Line Circuit Access Switch) applications that require asymmetrical protection in discrete (individual) packages. They enable the protected equipment to meet various regulatory requirements including GR 1089, ITU K.20, K.21, K.45, IEG 60950, UL 60950, and TIA-968.

Electrical Parameters

Part Number *	V _{DRM} Volts	V _S Volts	V _T Volts	I _{DRM} μ Amps	I _S mAmps	I _T Amps	I _H mAmps	C _O pF
P1200S_	100	130	4	5	800	2.2	120	40
P2000S_	180	220	4	5	800	2.2	120	30
P2500S_	230	290	4	5	800	2.2	120	30

* For individual "SA", "SB", and "SC" surge ratings, see table below.

General Notes:

- All measurements are made at an ambient temperature of 25 °C. I_{PP} applies to -40 °C through +85 °C temperature range.
- I_{PP} is a repetitive surge rating and is guaranteed for the life of the product.
- Listed *SIDACTor* devices are bi-directional. All electrical parameters and surge ratings apply to forward and reverse polarities.
- V_{DRM} is measured at I_{DRM}.
- V_S is measured at 100 V/ μ s.
- Special voltage (V_S and V_{DRM}) and holding current (I_H) requirements are available upon request.
- Off-state capacitance is measured between Pins 1-2 and 3-2 at 1 MHz with a 2 V bias and is a typical value for "SA" and "SB" product. "SC" capacitance is approximately 10 pF higher.

Surge Ratings

Series	I _{PP} 2x10 μ s Amps	I _{PP} 8x20 μ s Amps	I _{PP} 10x160 μ s Amps	I _{PP} 10x560 μ s Amps	I _{PP} 10x1000 μ s Amps	I _{TSM} 60 Hz Amps	di/dt Amps/ μ s
A	150	150	90	50	45	20	500
B	250	250	150	100	80	30	500
C	500	400	200	150	100	50	500

Thermal Considerations

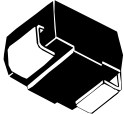
Package	Symbol	Parameter	Value	Unit
	T_J	Operating Junction Temperature Range	-40 to +125	$^{\circ}\text{C}$
	T_S	Storage Temperature Range	-65 to +150	$^{\circ}\text{C}$
	$R_{\theta JA}$	Thermal Resistance: Junction to Ambient	60	$^{\circ}\text{C/W}$

Data Sheets

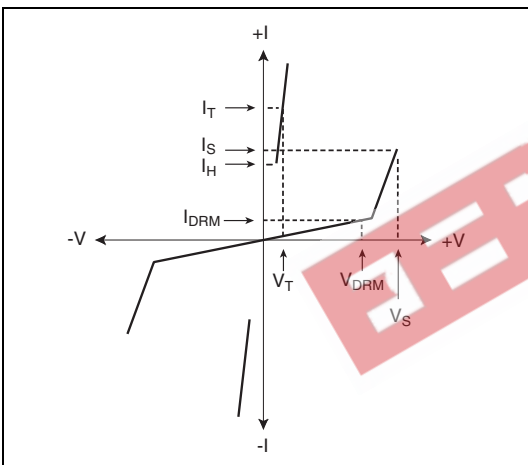

V-I Characteristics

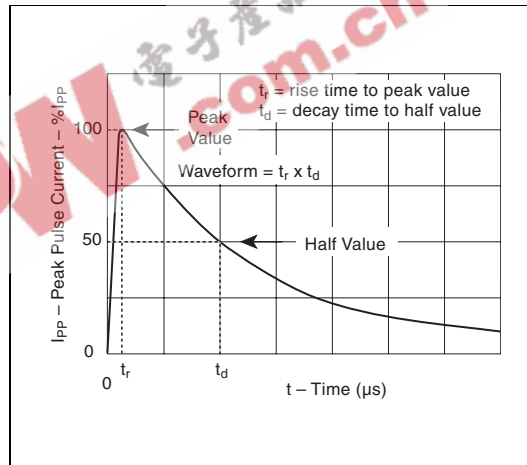

$t_r \times t_d$ Pulse Wave-form

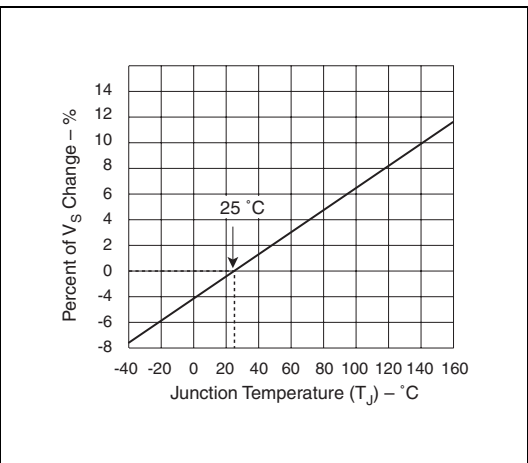

Normalized V_S Change versus Junction Temperature

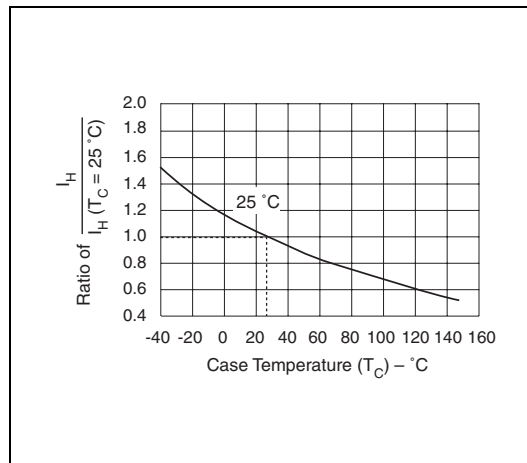

Normalized DC Holding Current versus Case Temperature

Four-Port Balanced Three-chip Protector

This hybrid Single In-line Package (SIP) protects four twisted pairs from overcurrent and overvoltage conditions. Comprised of twelve discrete DO-214AA *SIDACTor* devices and eight *TeleLink* surface mount fuses, it is ideal for densely populated line cards that cannot afford PCB inefficiencies or the use of series power resistors. Surge current ratings up to 500 A are available.

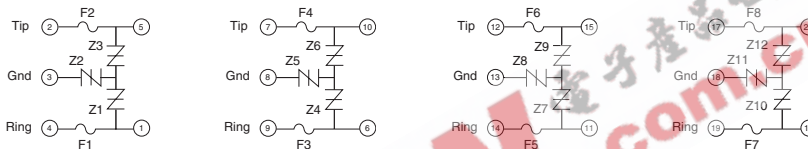

Electrical Parameters

Part Number *	V _{DRM} Volts	V _S Volts	V _{DRM} Volts	V _S Volts	V _T Volts	I _{DRM} μAmps	I _S mAmps	I _T Amps	I _H mAmps	C _O pF
	Pins 2-3, 4-3, 7-8, 9-8, 12-13, 14-13, 17-18, 19-18		Pins 2-4, 7-9, 12-14, 17-19							Pins 1-3
P1553Z_	130	180	130	180	8	5	800	2.2	150	40
P1803Z_	150	210	150	210	8	5	800	2.2	150	40
P2103Z_	170	250	170	250	8	5	800	2.2	150	40
P2353Z_	200	270	200	270	8	5	800	2.2	150	40
P2703Z_	230	300	230	300	8	5	800	2.2	150	30
P3203Z_	270	350	270	350	8	5	800	2.2	150	30
P3403Z_	300	400	300	400	8	5	800	2.2	150	30
A2106Z_ **	170	250	50	80	8	5	800	2.2	120	40
A5030Z_ **	400	550	270	350	8	5	800	2.2	150	30

* For individual "ZA," "ZB," and "ZC" surge ratings, see table below.

** Asymmetrical

General Notes:

- All measurements are made at an ambient temperature of 25 °C. I_{PP} applies to -40 °C through +85 °C temperature range.
- I_{PP} is a repetitive surge rating and is guaranteed for the life of the product.
- Listed *SIDACTor* devices are bi-directional. All electrical parameters and surge ratings apply to forward and reverse polarities.
- V_{DRM} is measured at I_{DRM}.
- V_S is measured at 100 V/μs.
- Special voltage (V_S and V_{DRM}) and holding current (I_H) requirements are available upon request.
- Off-state capacitance is measured between Pins 4-3 and Pins 2-3 at 1 MHz with a 2 V bias and is a typical value for "ZA" product. "ZB" and "ZC" capacitance is approximately 10 pF higher.
- Device is designed to meet balance requirements of GTS 8700 and GR 974.

Surge Ratings

Series	I _{PP} 2x10 μs Amps	I _{PP} 8x20 μs Amps	I _{PP} 10x160 μs Amps	I _{PP} 10x560 μs Amps	I _{PP} 10x1000 μs Amps	I _{TSM} 60 Hz Amps	di/dt Amps/μs
A	150	150	90	50	45	20	500
B	250	250	150	100	80	30	500
C	500	400	200	150	100	50	500

Thermal Considerations

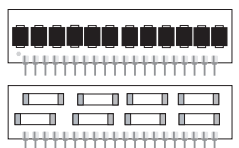
Package	Symbol	Parameter	Value	Unit
	T_J	Operating Junction Temperature Range	-40 to +150	$^{\circ}\text{C}$
	T_S	Storage Temperature Range	-65 to +150	$^{\circ}\text{C}$
	$R_{\theta JA}$	Thermal Resistance: Junction to Ambient	90	$^{\circ}\text{C}/\text{W}$

Data Sheets

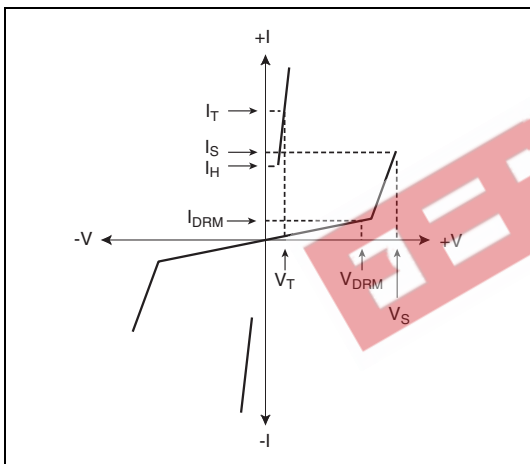

V-I Characteristics

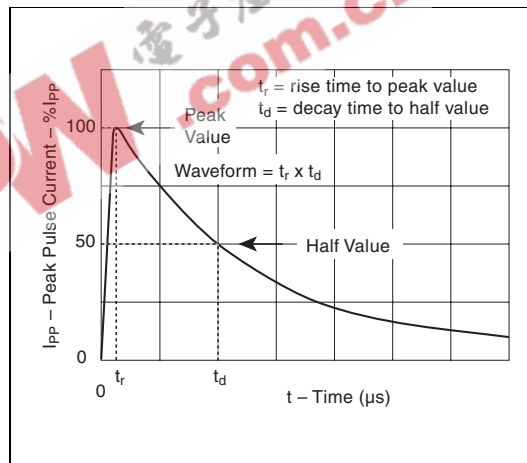

$t_r \times t_d$ Pulse Waveform

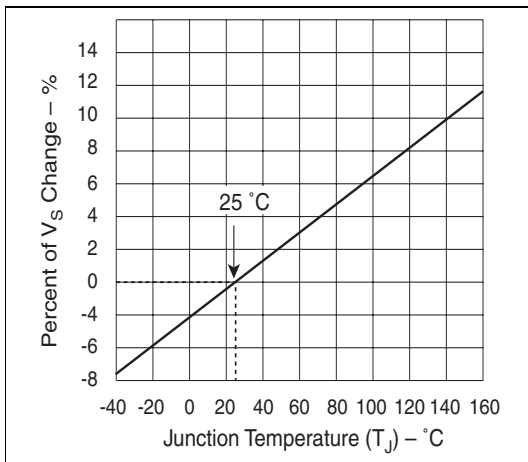

Normalized V_S Change versus Junction Temperature

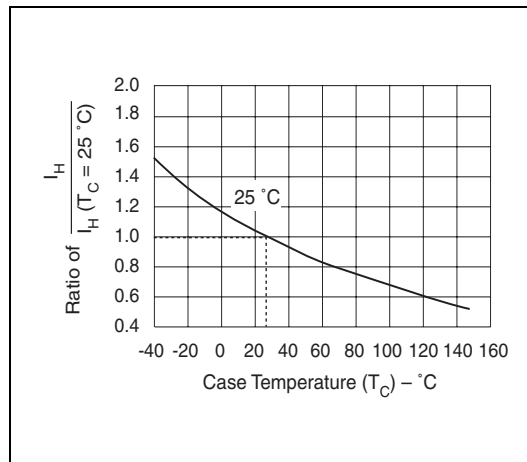

Normalized DC Holding Current versus Case Temperature

Four-Port Longitudinal Two-chip Protector

This hybrid Single In-line Package (SIP) protects four twisted pairs from overcurrent and overvoltage conditions. Comprised of eight discrete DO-214AA *SIDACTor* devices and eight *TeleLink* surface mount fuses, it is ideal for densely populated line cards that cannot afford PCB inefficiencies or the use of series power resistors. Surge current ratings up to 500 A are available.

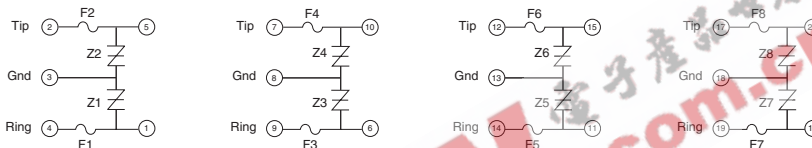

Electrical Parameters

Part Number *	V _{DRM} Volts	V _S Volts	V _{DRM} Volts	V _S Volts	V _T Volts	I _{DRM} μAmps	I _S mAmps	I _T Amps	I _H mAmps	Co pF
	Pins 2-3, 4-3, 7-8, 9-8, 12-13, 14-13, 17-18, 19-18		Pins 2-4, 7-9, 12-14, 17-19							Pins 2-3, 3-4
P0602Z_	25	40	50	80	4	5	800	2.2	50	110
P1402Z_	58	77	116	154	4	5	800	2.2	150	50
P1602Z_	65	95	130	190	4	5	800	2.2	150	50
P2202Z_	90	130	180	260	4	5	800	2.2	150	40
P2702Z_	120	160	240	320	4	5	800	2.2	150	40
P3002Z_	140	180	280	360	4	5	800	2.2	150	40
P3602Z_	160	220	320	440	4	5	800	2.2	150	40
P4202Z_	190	250	380	500	4	5	800	2.2	150	30
P4802Z_	220	300	440	600	4	5	800	2.2	150	30
P6002Z_	275	350	550	700	4	5	800	2.2	150	30

* For individual "ZA," "ZB," and "ZC" surge ratings, see table below.

General Notes:

- All measurements are made at an ambient temperature of 25 °C. I_{PP} applies to -40 °C through +85 °C temperature range.
- I_{PP} is a repetitive surge rating and is guaranteed for the life of the product.
- Listed *SIDACTor* devices are bi-directional. All electrical parameters and surge ratings apply to forward and reverse polarities.
- V_{DRM} is measured at I_{DRM}.
- V_S is measured at 100 V/μs.
- Special voltage (V_S and V_{DRM}) and holding current (I_H) requirements are available upon request.
- Off-state capacitance is measured between Pins 4-3 and Pins 2-3 at 1 MHz with a 2 V bias and is a typical value for "ZA" product. "ZB" and "ZC" capacitance is approximately 2x higher.
- Device is designed to meet balance requirements of GTS 8700 and GR 974.
- Lower capacitance MC versions may be available. Contact factory for further information.

Surge Ratings

Series	I _{PP} 2x10 μs Amps	I _{PP} 8x20 μs Amps	I _{PP} 10x160 μs Amps	I _{PP} 10x560 μs Amps	I _{PP} 10x1000 μs Amps	I _{TSM} 60 Hz Amps	di/dt Amps/μs
A	150	150	90	50	45	20	500
B	250	250	150	100	80	30	500
C	500	400	200	150	100	50	500

Thermal Considerations

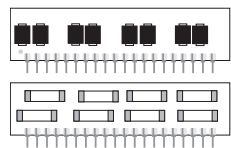
Package	Symbol	Parameter	Value	Unit
	T_J	Operating Junction Temperature Range	-40 to +150	$^{\circ}\text{C}$
	T_S	Storage Temperature Range	-65 to +150	$^{\circ}\text{C}$
	$R_{\theta JA}$	Thermal Resistance: Junction to Ambient	90	$^{\circ}\text{C/W}$

Data Sheets

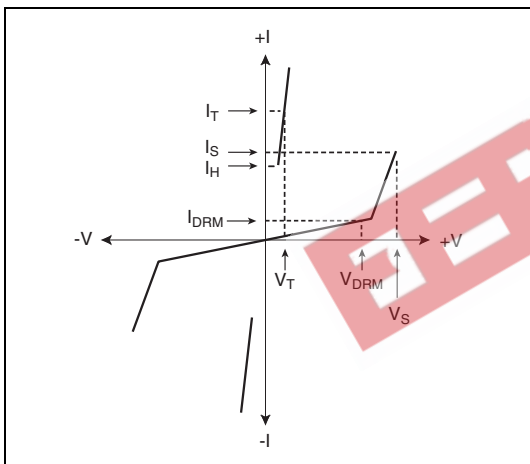

V-I Characteristics

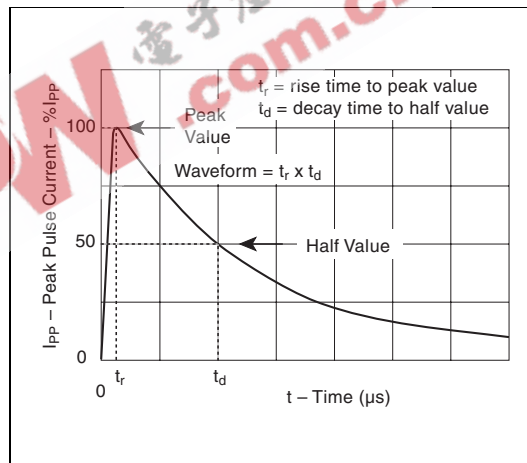

$t_r \times t_d$ Pulse Waveform

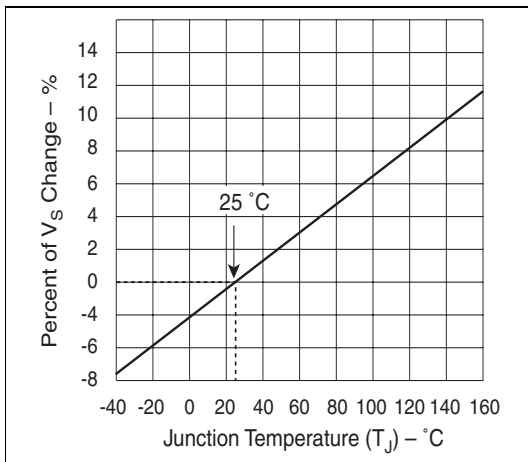

Normalized V_S Change versus Junction Temperature

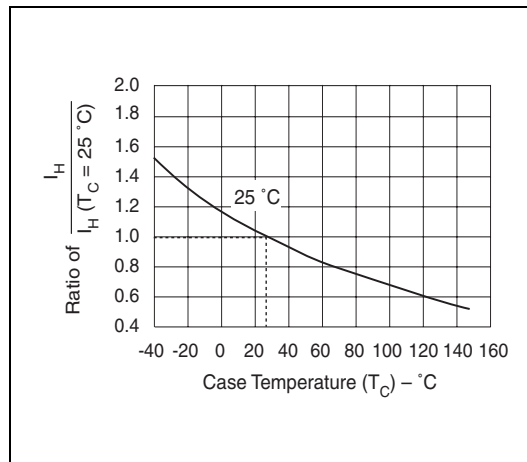

Normalized DC Holding Current versus Case Temperature

Four-Port Metallic Line Protector

The four-port hybrid Single In-line Package (SIP) line protector protects multiple twisted pair from overcurrent and overvoltage conditions. Based on a SIP, it is equivalent to four discrete DO-214AA *SIDACtor* devices and four surface mount fuses. Available in surge current ratings up to 500 A, this four-port SIP line protector is ideal for densely populated line cards that cannot afford PCB inefficiencies or the use of series power resistors.

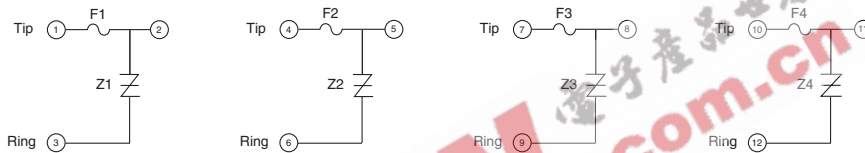

Electrical Parameters

Part Number *	V _{DRM} Volts	V _S Volts	V _T Volts	I _{DRM} μ Amps	I _S mAmps	I _T Amps	I _H mAmps	C _o pF
P0080Z_	6	25	4	5	800	2.2	50	100
P0300Z_	25	40	4	5	800	2.2	50	110
P0640Z_	58	77	4	5	800	2.2	150	50
P0720Z_	65	88	4	5	800	2.2	150	50
P0900Z_	75	98	4	5	800	2.2	150	50
P1100Z_	90	130	4	5	800	2.2	150	40
P1300Z_	120	160	4	5	800	2.2	150	40
P1500Z_	140	180	4	5	800	2.2	150	40
P1800Z_	170	220	4	5	800	2.2	150	30
P2300Z_	190	260	4	5	800	2.2	150	30
P2600Z_	220	300	4	5	800	2.2	150	30
P3100Z_	275	350	4	5	800	2.2	150	30
P3500Z_	320	400	4	5	800	2.2	150	30

* For individual "ZA," "ZB," and "ZC" surge ratings, see table below.

General Notes:

- All measurements are made at an ambient temperature of 25 °C. I_{PP} applies to -40 °C through +85 °C temperature range.
- I_{PP} is a repetitive surge rating and is guaranteed for the life of the product.
- Listed *SIDACtor* devices are bi-directional. All electrical parameters and surge ratings apply to forward and reverse polarities.
- V_{DRM} is measured at I_{DRM}.
- V_S is measured at 100 V/ μ s.
- Special voltage (V_S and V_{DRM}) and holding current (I_H) requirements are available upon request.
- Off-state capacitance is measured at 1 MHz with a 2 V bias and is a typical value for "ZA" and "ZB" product. "ZC" capacitance is approximately 2x the listed value.
- Lower capacitance MC versions may be available. Contact factory for further information.

Surge Ratings

Series	I _{PP} 2x10 μ s Amps	I _{PP} 8x20 μ s Amps	I _{PP} 10x160 μ s Amps	I _{PP} 10x560 μ s Amps	I _{PP} 10x1000 μ s Amps	I _{TSM} 60 Hz Amps	di/dt Amps/ μ s
A	150	150	90	50	45	20	500
B	250	250	150	100	80	30	500
C	500	400	200	150	100	50	500

Thermal Considerations

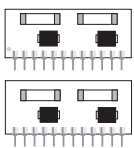
Package	Symbol	Parameter	Value	Unit
	T_J	Operating Junction Temperature Range	-40 to +150	$^{\circ}\text{C}$
	T_S	Storage Temperature Range	-65 to +150	$^{\circ}\text{C}$
	$R_{\theta JA}$	Thermal Resistance: Junction to Ambient	90	$^{\circ}\text{C/W}$

Data Sheets

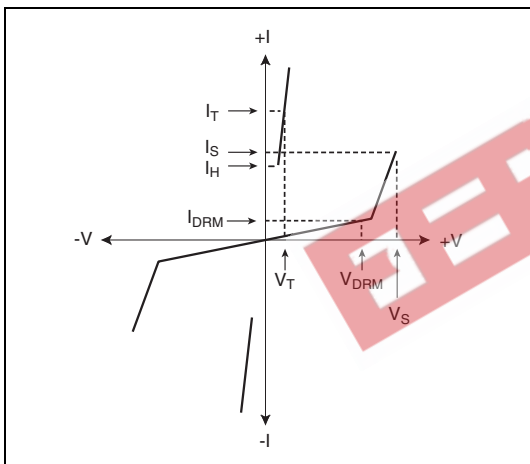

V-I Characteristics

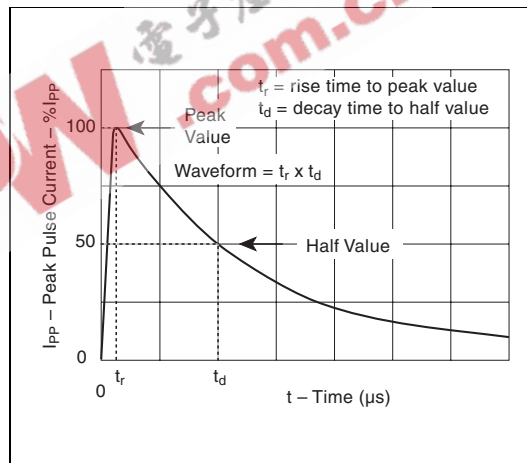

$t_r \times t_d$ Pulse Waveform

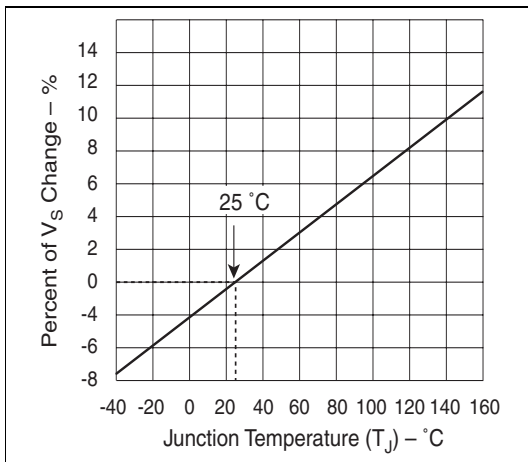

Normalized V_S Change versus Junction Temperature

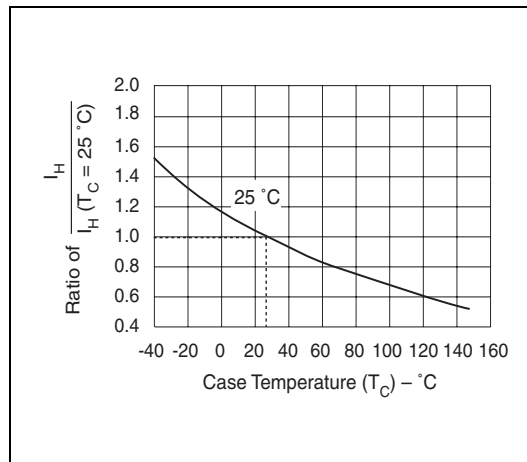

Normalized DC Holding Current versus Case Temperature

Fixed Voltage SLIC Protector

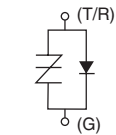

These DO-214AA unidirectional protectors are constructed with a *SIDACTor* device and an integrated diode. They protect SLICs (Subscriber Line Interface Circuits) from damage during transient voltage activity and enable line cards to meet various regulatory requirements including GR 1089, ITU K.20, K.21 and K.45, IEC 60950, UL 60950, and TIA-968 (formerly known as FCC Part 68).

For specific design criteria, see details in Figure 3.21.

Electrical Parameters

Part Number *	V _{DRM} Volts	V _S Volts	V _T Volts	V _F Volts	I _{DRM} μ Amps	I _S mAmps	I _T Amps	I _H mAmps	C _O pF
P0641S_	58	77	4	5	5	800	1	120	70
P0721S_	65	88	4	5	5	800	1	120	70
P0901S_	75	98	4	5	5	800	1	120	70
P1101S_	95	130	4	5	5	800	1	120	70

* For individual "SA" and "SC" surge ratings, see table below.

General Notes:

- All measurements are made at an ambient temperature of 25 °C. I_{PP} applies to -40 °C through +85 °C temperature range.
- I_{PP} is a repetitive surge rating and is guaranteed for the life of the product.
- V_{DRM} is measured at I_{DRM}.
- V_S and V_F are measured at 100 V/ μ s.
- Special voltage (V_S and V_{DRM}) and holding current (I_H) requirements are available upon request.
- Off-state capacitance is measured at 1 MHz with a 2 V bias and is a typical value for "SA" and "SB" product. "SC" capacitance is approximately 2x the listed value.
- Parallel capacitive loads may affect electrical parameters.

Surge Ratings (Preliminary Data)

Series	I _{PP} 2x10 μ s Amps	I _{PP} 8x20 μ s Amps	I _{PP} 10x160 μ s Amps	I _{PP} 10x560 μ s Amps	I _{PP} 10x1000 μ s Amps	I _{RSM} 60 Hz Amps	di/dt Amps/ μ s
A	150	150	90	50	45	20	500
C	500	400	200	120	100	50	500

Thermal Considerations

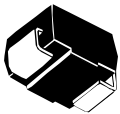
Package	Symbol	Parameter	Value	Unit
	T_J	Operating Junction Temperature Range	-40 to +150	$^{\circ}\text{C}$
	T_S	Storage Temperature Range	-65 to +150	$^{\circ}\text{C}$
	$R_{\theta JA}$	Thermal Resistance: Junction to Ambient	90	$^{\circ}\text{C/W}$

Data Sheets

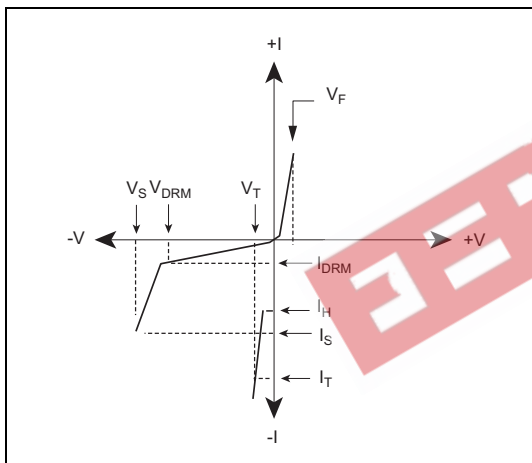

V-I Characteristics

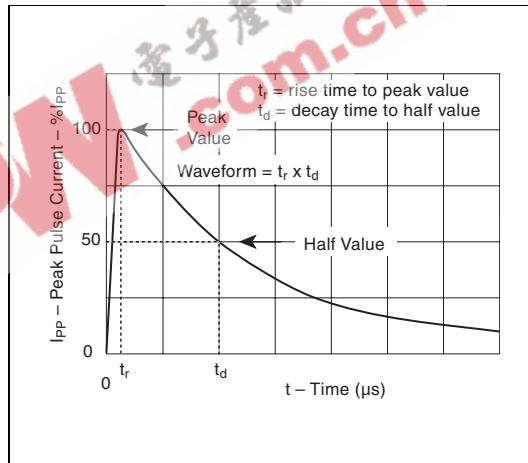

$t_r \times t_d$ Pulse Wave-form

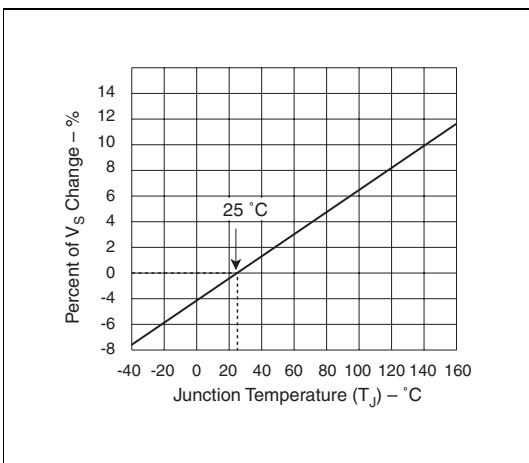

Normalized V_S Change versus Junction Temperature

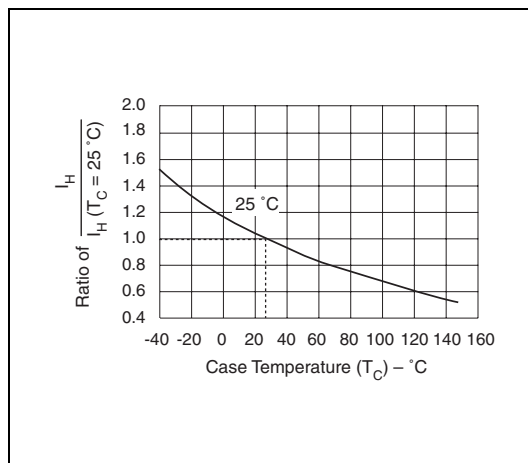

Normalized DC Holding Current versus Case Temperature

Twin SLIC Protector

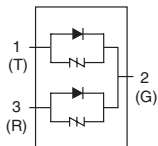

Subscriber Line Interface Circuits (SLIC) are highly susceptible to transient voltages, such as lightning and power cross conditions. To minimize this threat, Teccor provides this dual-chip, fixed-voltage SLIC protector device.

For specific design criteria, see details in Figure 3.23.

Electrical Parameters

Part Number *	V _{DRM} Volts	V _S Volts	V _{DRM} Volts	V _S Volts	V _T Volts	V _F Volts	I _{DRM} μ Amps	I _S mAmps	I _T Amps	I _H mAmps	C _O pF
	Pins 1-2, 2-3		Pins 1-3								
P0641CA2	58	77	58	77	4	5	5	800	1	120	60
P0721CA2	65	88	65	88	4	5	5	800	1	120	60
P0901CA2	75	98	75	98	4	5	5	800	1	120	60
P1101CA2	95	130	95	130	4	5	5	800	1	120	60

* For surge ratings, see table below.

General Notes:

- All measurements are made at an ambient temperature of 25 °C. I_{PP} applies to -40 °C through +85 °C temperature range.
- I_{PP} is a repetitive surge rating and is guaranteed for the life of the product.
- V_{DRM} is measured at I_{DRM}.
- V_S and V_F are measured at 100 V/ μ s.
- Special voltage (V_S and V_{DRM}) and holding current (I_H) requirements are available upon request.
- Off-state capacitance is measured across pins 1-2 or 2-3 at 1 MHz with a 2 V bias. Capacitance across pins 1-3 is approximately half.
- Parallel capacitive loads may affect electrical parameters.
- Compliance with GR 1089 or UL 60950 power cross tests may require special design considerations. Contact the factory for further information.

Surge Ratings (Preliminary Data)

Series	I _{PP} 2x10 μ s Amps	I _{PP} 8x20 μ s Amps	I _{PP} 10x160 μ s Amps	I _{PP} 10x560 μ s Amps	I _{PP} 10x1000 μ s Amps	I _{TSM} 60 Hz Amps	di/dt Amps/ μ s
A	150	150	90	50	45	20	500

Thermal Considerations

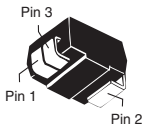
Package	Symbol	Parameter	Value	Unit
 Modified DO-214AA	T_J	Operating Junction Temperature Range	-40 to +150	$^{\circ}\text{C}$
	T_S	Storage Temperature Range	-65 to +150	$^{\circ}\text{C}$
	$R_{\theta JA}$	Thermal Resistance: Junction to Ambient	85	$^{\circ}\text{C/W}$

Data Sheets

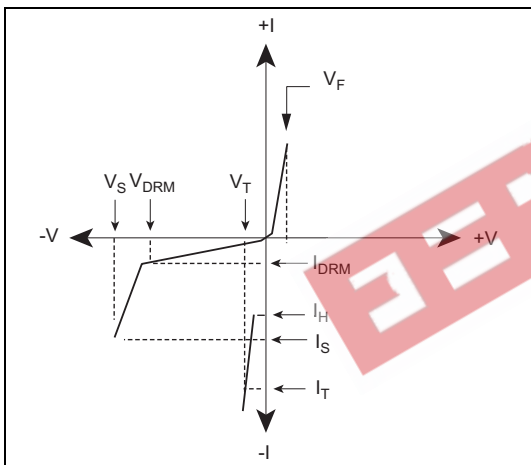

V-I Characteristics

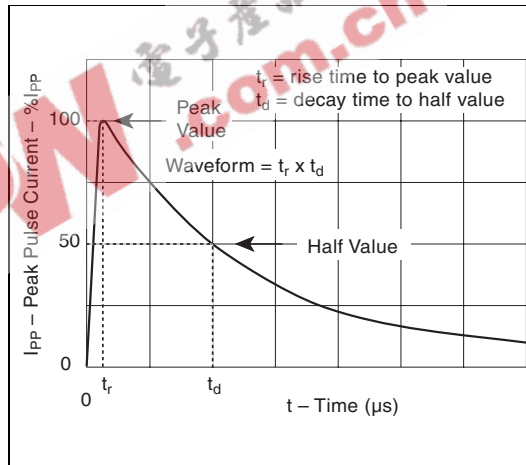

$t_r \times t_d$ Pulse Wave-form

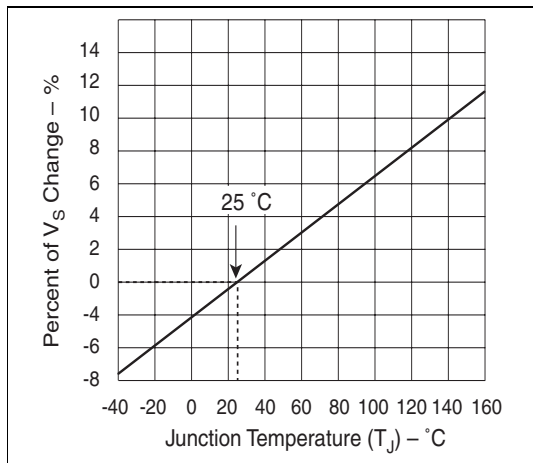

Normalized V_S Change versus Junction Temperature

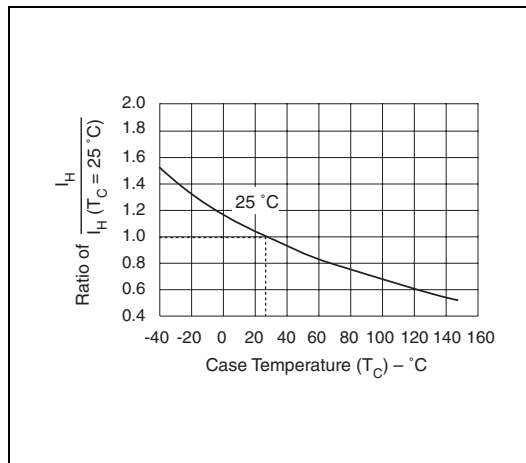

Normalized DC Holding Current versus Case Temperature

Multiport SLIC Protector

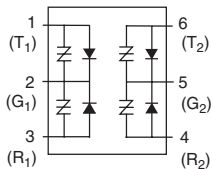

This multiport line protector is designed as a single-package solution for protecting multiple twisted pair from overvoltage conditions. Based on a six-pin SOIC package, it is equivalent to four discrete DO-214AA packages. Available in surge current ratings up to 500 A for a 2x10 μ s event, the multiport line protector is ideal for densely populated line cards that cannot afford PCB inefficiencies or the use of series power resistors.

For specific design criteria, see details in Figure 3.24.

Electrical Parameters

Part Number *	V _{DRM} Volts	V _S Volts	V _{DRM} Volts	V _S Volts	V _T Volts	V _F Volts	I _{DRM} μ Amps	I _S mAmps	I _T Amps	I _H mAmps	C _O pF
	Pins 1-2, 2-3, 4-5, 5-6		Pins 1-3, 4-6								
P0641U_	58	77	58	77	4	5	5	800	1	120	70
P0721U_	65	88	65	88	4	5	5	800	1	120	70
P0901U_	75	98	75	98	4	5	5	800	1	120	70
P1101U_	95	130	95	130	4	5	5	800	1	120	70

* For individual "UA" and "UC" surge ratings, see table below.

General Notes:

- All measurements are made at an ambient temperature of 25 °C. I_{PP} applies to -40 °C through +85 °C temperature range.
- I_{PP} is a repetitive surge rating and is guaranteed for the life of the product.
- V_{DRM} is measured at I_{DRM}.
- V_S and V_F are measured at 100 V/ μ s.
- Special voltage (V_S and V_{DRM}) and holding current (I_H) requirements are available upon request.
- Off-state capacitance is measured across pins 1-2, 2-3, 4-5, or 5-6 at 1 MHz with a 2 V bias and is a typical value. Capacitance across pins 1-3 or 4-6 is approximately half. "UC" capacitance is approximately 2x the listed value for "UA" product.
- Parallel capacitive loads may affect electrical parameters.

Surge Ratings

Series	I _{PP} 2x10 μ s Amps	I _{PP} 8x20 μ s Amps	I _{PP} 10x160 μ s Amps	I _{PP} 10x560 μ s Amps	I _{PP} 10x1000 μ s Amps	I _{TSM} 60 Hz Amps	di/dt Amps/ μ s
A	150	150	90	50	45	20	500
C	500	400	200	120	100	50	500

Thermal Considerations

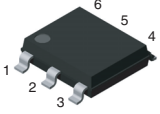
Package	Symbol	Parameter	Value	Unit
	T_J	Operating Junction Temperature Range	-40 to +150	$^{\circ}\text{C}$
	T_S	Storage Temperature Range	-65 to +150	$^{\circ}\text{C}$
	$R_{\theta JA}$	Thermal Resistance: Junction to Ambient	60	$^{\circ}\text{C}/\text{W}$

Data Sheets

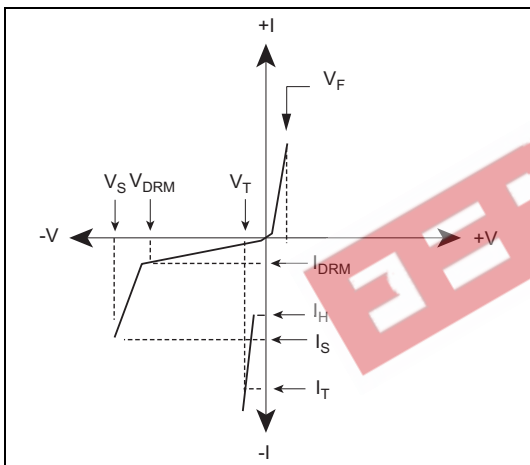

V-I Characteristics

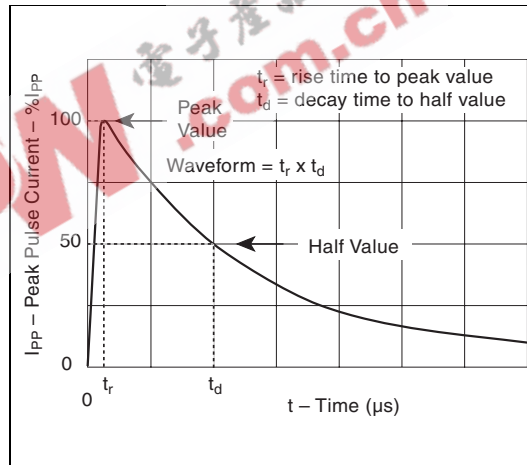

$t_r \times t_d$ Pulse Wave-form

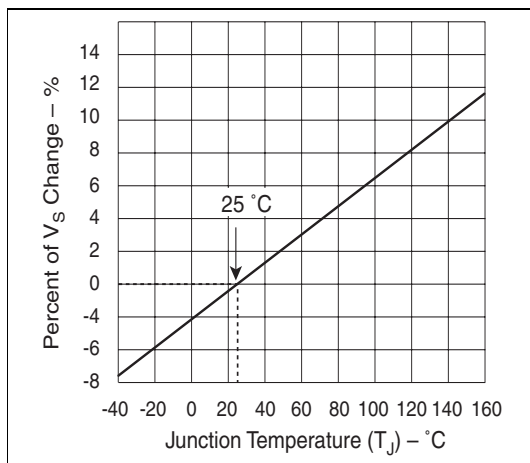

Normalized V_S Change versus Junction Temperature

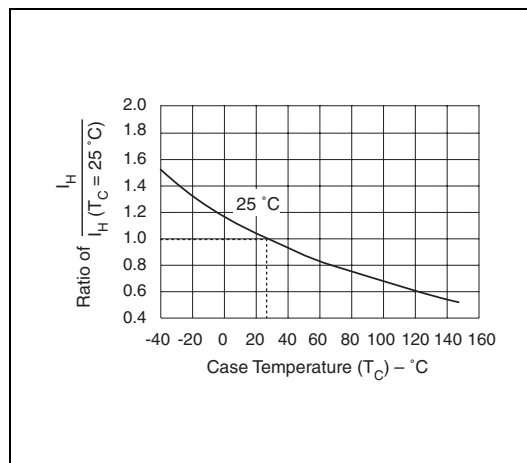

Normalized DC Holding Current versus Case Temperature

Battrax SLIC Protector

This solid state protection device can be referenced to either a positive or negative voltage source. The B1xx0C_ is for a $-V_{REF}$ and the B2050C_ is for a $+V_{REF}$. Designed using an SCR and a gate diode, the B1xx0C_ Battrax begins to conduct at $|-V_{REF}| + |-1.2 V|$ while the B2050C_ Battrax begins to conduct at $|+V_{REF}| + |1.2 V|$.

For a diagram of a Battrax application, see Figure 3.29.

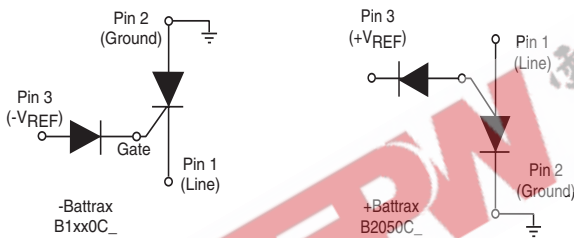

Electrical Parameters

Part Number *	V_{DRM} Volts	V_S Volts	V_T Volts	I_{DRM} μ Amps	I_{GT} mAmps	I_T Amps	I_H mAmps	C_O pF
B1100C_	$ -V_{REF} + -1.2 V $	$ -V_{REF} + -10 V $	4	5	100	1	100	50
B1160C_	$ -V_{REF} + -1.2 V $	$ -V_{REF} + -10 V $	4	5	100	1	160	50
B1200C_	$ -V_{REF} + -1.2 V $	$ -V_{REF} + -10 V $	4	5	100	1	200	50
B2050C_	$ +V_{REF} + 1.2 V $	$ +V_{REF} + 10 V $	4	5	50	1	5	50

* For individual "CA" and "CC" surge ratings, see table below.

General Notes:

- All measurements are made at an ambient temperature of 25 °C. I_{PP} applies to -40 °C through +85 °C temperature range.
- I_{PP} is a repetitive surge rating and is guaranteed for the life of the product.
- I_{PP} ratings assume $V_{REF} = \pm 48 V$.
- V_{DRM} is measured at I_{DRM} .
- V_S is measured at 100 V/ μ s.
- Off-state capacitance is measured at 1 MHz with a 2 V bias and is a typical value. "CC" product is approximately 2x the listed value.
- Positive Battrax information is preliminary data.
- V_{REF} maximum value for the negative Battrax is -200 V.
- V_{REF} maximum value for the positive Battrax is 110 V.

Surge Ratings

Series	I_{PP} 2x10 μ s Amps	I_{PP} 8x20 μ s Amps	I_{PP} 10x160 μ s Amps	I_{PP} 10x560 μ s Amps	I_{PP} 10x1000 μ s Amps	I_{TSM} 60 Hz Amps	di/dt Amps/ μ s
A	150	150	90	60	50	40	500
C	500	400	200	150	100	50	500

Thermal Considerations

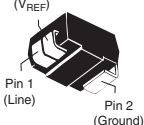
Package	Symbol	Parameter	Value	Unit
Modified DO-214AA 	T_J	Operating Junction Temperature Range	-40 to +150	$^{\circ}\text{C}$
	T_S	Storage Temperature Range	-65 to +150	$^{\circ}\text{C}$
	$R_{\theta JA}$	Thermal Resistance: Junction to Ambient	85	$^{\circ}\text{C/W}$

Data Sheets

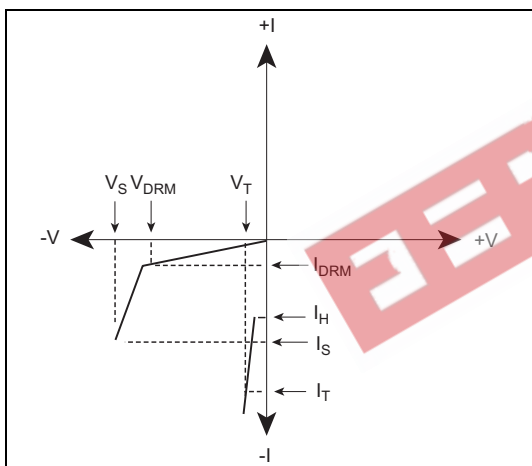

V-I Characteristics for Negative Batrax

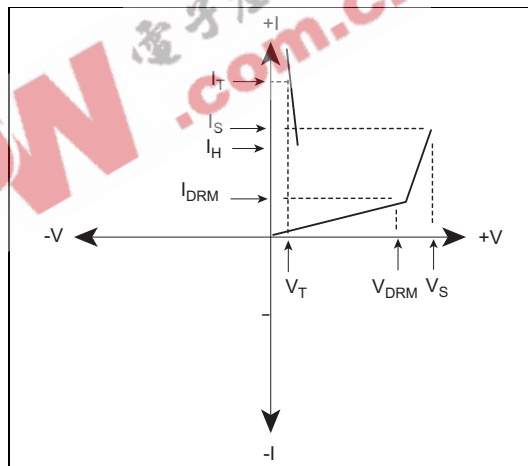

V-I Characteristics for Positive Batrax

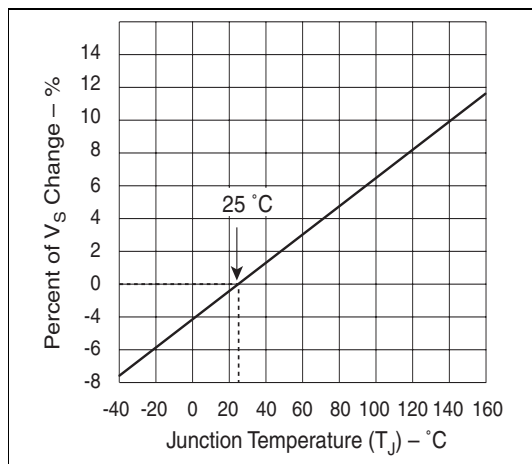

Normalized V_S Change versus Junction Temperature

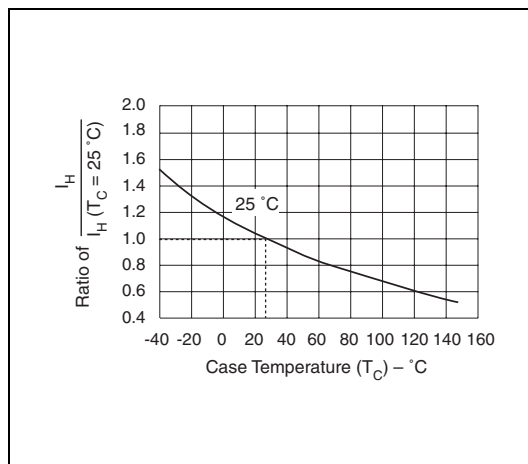

Normalized DC Holding Current versus Case Temperature

Batrax Dual Negative SLIC Protector

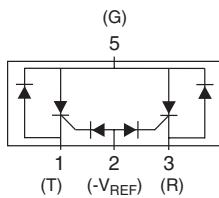

This solid state *Batrax* protection device is referenced to a negative voltage source. Its dual-chip package also includes internal diodes for transient protection from positive surge events.

For a diagram of a *Batrax* application, see Figure 3.27.

Electrical Parameters

Part Number *	V _{DRM} Volts	V _S Volts	V _T Volts	V _F Volts	I _{DRM} μ Amps	I _{GT} mAmps	I _T Amps	I _H mAmps	C _O pF
B1101U_	-V _{REF} + -1.2V	-V _{REF} + -10V	4	5	5	100	1	100	50
B1161U_	-V _{REF} + -1.2V	-V _{REF} + -10V	4	5	5	100	1	160	50
B1201U_	-V _{REF} + -1.2V	-V _{REF} + -10V	4	5	5	100	1	200	50

* For individual "UA" and "UC" surge ratings, see table below.

General Notes:

- All measurements are made at an ambient temperature of 25 °C. I_{PP} applies to -40 °C through +85 °C temperature range.
- I_{PP} is a repetitive surge rating and is guaranteed for the life of the product.
- I_{PP} ratings assume a V_{REF} = -48 V.
- V_{DRM} is measured at I_{DRM}.
- V_S is measured at 100 V/ μ s.
- Off-state capacitance is measured at 1 MHz with a 2 V bias and is a typical value. "UC" product is approximately 2x the listed value.
- V_{REF} maximum value for the B1101, B1161, and/or B1201 is -200 V.

Surge Ratings

Series	I _{PP} 2x10 μ s Amps	I _{PP} 8x20 μ s Amps	I _{PP} 10x160 μ s Amps	I _{PP} 10x560 μ s Amps	I _{PP} 10x1000 μ s Amps	I _{TSM} 60 Hz Amps	di/dt Amps/ μ s
A	150	150	90	50	45	20	500
C**	500	400	200	120	100	50	500

** Call factory for release date.

Thermal Considerations

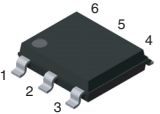
Package	Symbol	Parameter	Value	Unit
	T_J	Operating Junction Temperature Range	-40 to +125	$^{\circ}\text{C}$
	T_S	Storage Temperature Range	-65 to +150	$^{\circ}\text{C}$
	$R_{\theta JA}$	Thermal Resistance: Junction to Ambient	60	$^{\circ}\text{C/W}$

Data Sheets

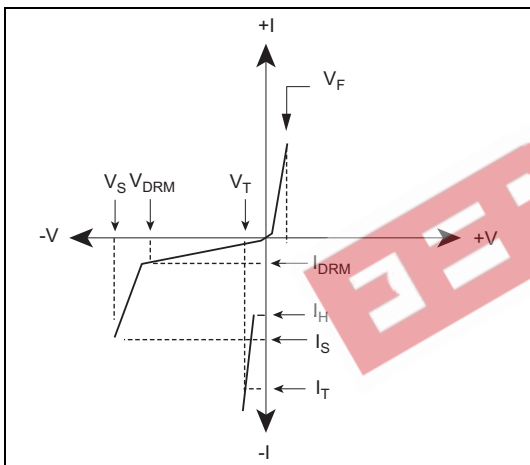

V-I Characteristics

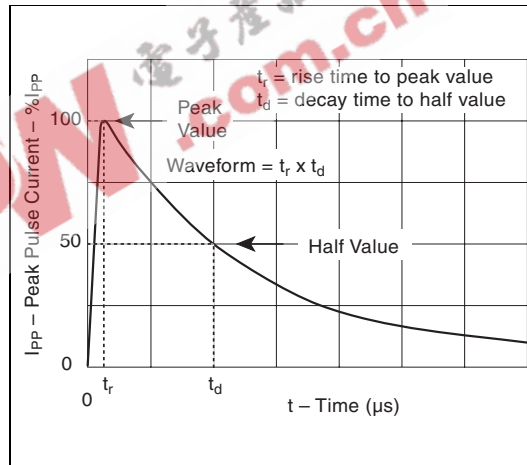

$t_r \times t_d$ Pulse Wave-form

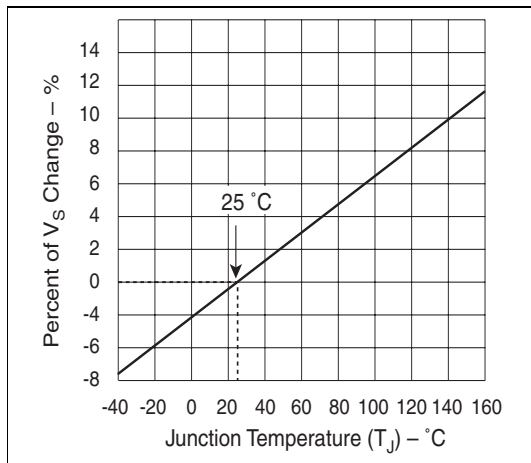

Normalized V_S Change versus Junction Temperature

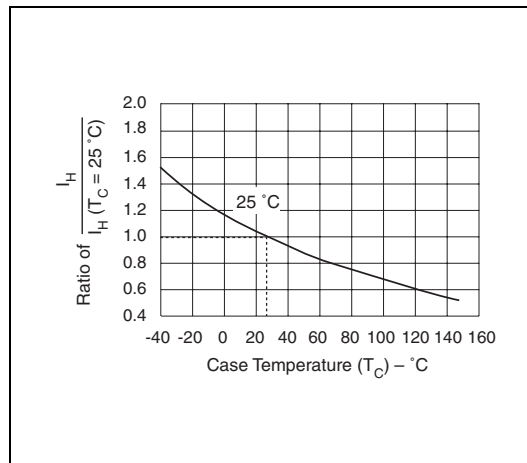

Normalized DC Holding Current versus Case Temperature

Battrax Dual Positive/Negative SLIC Protector

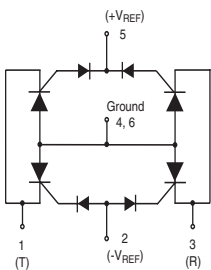

This *Battrax* device protects Subscriber Line Interface Circuits (SLIC) that use both a positive and negative Ring voltage. It limits transient voltages with rise times of 100 V/μs to $V_{REF} \pm 10$ V.

Teccor's six-pin *Battrax* devices are constructed using four SCRs and four gate diodes. The SCRs conduct when a voltage that is more negative than $-V_{REF}$ (and/or more positive than $+V_{REF}$) is applied to the cathode (Pins 1 and 3) of the SCR. During conduction, the SCRs appear as a low-resistive path which forces all transients to be shorted to ground.

For a diagram of a *Battrax* application, see Figure 3.30.

Electrical Parameters

Part Number *	V_{DRM} Volts	V_S Volts	V_T Volts	I_{DRM} μAmps	I_{GT} mAmps	I_T Amps	I_H mAmps	C_O pF
B3104U_	$ -V_{REF} + \pm 1.2V $	$ -V_{REF} + \pm 10V $	4	5	100	1	100	50
B3164U_	$ -V_{REF} + \pm 1.2V $	$ -V_{REF} + \pm 10V $	4	5	100	1	160	50
B3204U_	$ -V_{REF} + \pm 1.2V $	$ -V_{REF} + \pm 10V $	4	5	100	1	200	50

* For individual "UA" and "UC" surge ratings, see table below.

General Notes:

- All measurements are made at an ambient temperature of 25 °C. I_{PP} applies to -40 °C through +85 °C temperature range.
- I_{PP} is a repetitive surge rating and is guaranteed for the life of the product.
- I_{PP} ratings assume a $V_{REF} = \pm 48$ V.
- V_{DRM} is measured at I_{DRM} .
- V_S is measured at 100 V/μs.
- Off-state capacitance is measured at 1 MHz with a 2 V bias and is a typical value. "UC" product is approximately 2x the listed value.
- Positive *Battrax* information is preliminary data.
- V_{REF} maximum value for the negative *Battrax* is -200 V.
- V_{REF} maximum value for the positive *Battrax* is 110 V.

Surge Ratings

Series	I_{PP} 2x10 μs Amps	I_{PP} 8x20 μs Amps	I_{PP} 10x160 μs Amps	I_{PP} 10x560 μs Amps	I_{PP} 10x1000 μs Amps	I_{TSM} 60 Hz Amps	di/dt Amps/μs
A	150	150	90	50	45	20	500
C**	500	400	200	120	100	50	500

** Call factory for release date.

Thermal Considerations

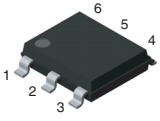
Package	Symbol	Parameter	Value	Unit
	T_J	Operating Junction Temperature Range	-40 to +125	$^{\circ}\text{C}$
	T_S	Storage Temperature Range	-65 to +150	$^{\circ}\text{C}$
	$R_{\theta JA}$	Thermal Resistance: Junction to Ambient	60	$^{\circ}\text{C/W}$

Data Sheets

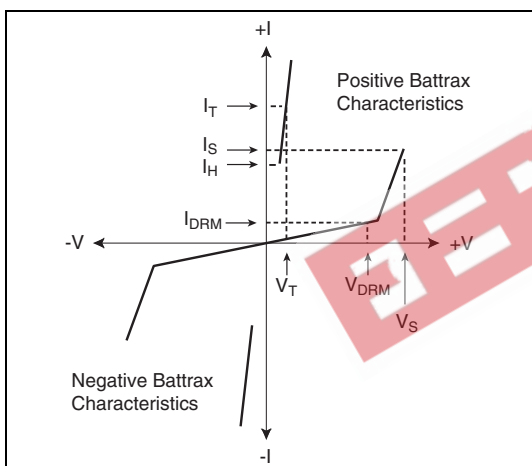

V-I Characteristics

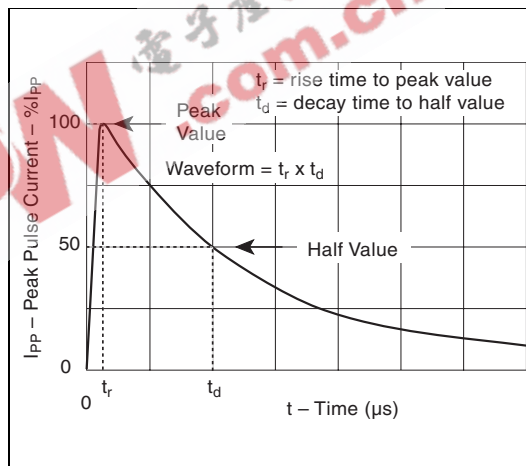

$t_r \times t_d$ Pulse Wave-form

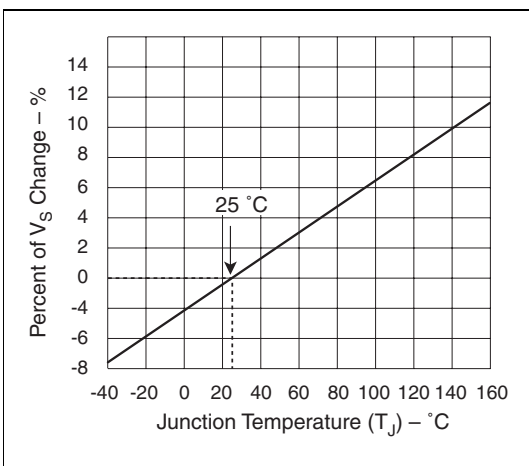

Normalized V_S Change versus Junction Temperature

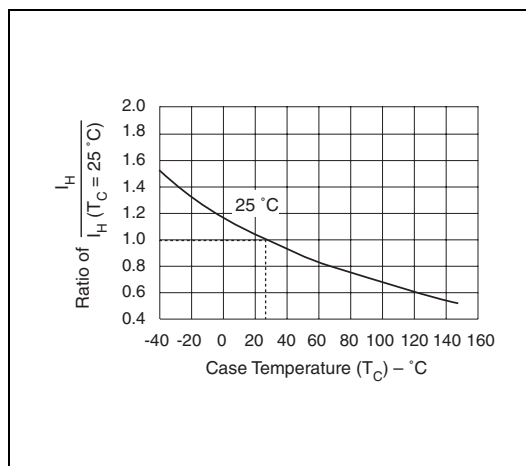

Normalized DC Holding Current versus Case Temperature

Batrax Quad Negative SLIC Protector

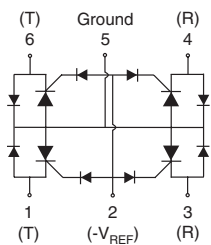

This *Batrax* device is an integrated overvoltage protection solution for SLIC-based (Subscriber Line Interface Circuit) line cards. This six-pin device is constructed using four SCRs and four gate diodes.

The device is referenced to V_{BAT} and conducts when a voltage that is more negative than $-V_{REF}$ is applied to the cathode (pins 1, 3, 4, or 6) of the SCR. During conduction, all negative transients are shorted to Ground. All positive transients are passed to Ground by steering diodes.

For specific diagrams showing these *Batrax* applications, see Figure 3.28.

Electrical Parameters

Part Number *	V_{DRM} Volts	V_S Volts	V_T Volts	I_{DRM} μ Amps	I_{GT} mAmps	I_T Amps	I_H mAmps	C_O pF
B1101U_4	$ -V_{REF} + -1.2V $	$ -V_{REF} + -10V $	4	5	100	1	100	50
B1161U_4	$ -V_{REF} + -1.2V $	$ -V_{REF} + -10V $	4	5	100	1	160	50
B1201U_4	$ -V_{REF} + -1.2V $	$ -V_{REF} + -10V $	4	5	100	1	200	50

* For individual "UA" and "UC" surge ratings, see table below.

General Notes:

- All measurements are made at an ambient temperature of 25 °C. I_{PP} applies to -40 °C through +85 °C temperature range.
- I_{PP} is a repetitive surge rating and is guaranteed for the life of the product.
- I_{PP} ratings assume a $V_{REF} = \pm 48$ V.
- V_{DRM} is measured at I_{DRM} .
- V_S is measured at 100 V/ μ s.
- Off-state capacitance is measured at 1 MHz with a 2 V bias and is a typical value. "UC" product is approximately 2x the listed value.
- V_{REF} maximum value for the negative Batrax is -200 V.

Surge Ratings

Series	I_{PP} 2x10 μ s Amps	I_{PP} 8x20 μ s Amps	I_{PP} 10x160 μ s Amps	I_{PP} 10x560 μ s Amps	I_{PP} 10x1000 μ s Amps	I_{TSM} 60 Hz Amps	di/dt Amps/ μ s
A	150	150	90	50	45	20	500
C	500	400	200	120	100	50	500

Thermal Considerations

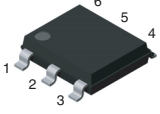
Package	Symbol	Parameter	Value	Unit
	T_J	Operating Junction Temperature Range	-40 to +125	$^{\circ}\text{C}$
	T_S	Storage Temperature Range	-65 to +150	$^{\circ}\text{C}$
	$R_{\theta JA}$	Thermal Resistance: Junction to Ambient	60	$^{\circ}\text{C/W}$

Data Sheets

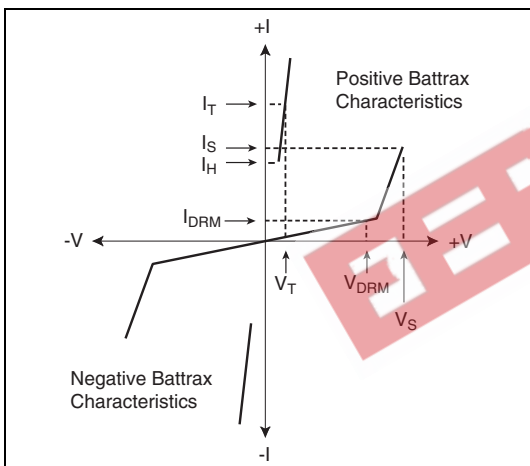

V-I Characteristics

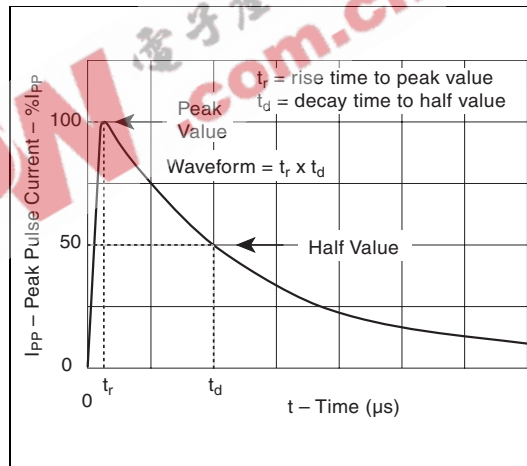

$t_r \times t_d$ Pulse Wave-form

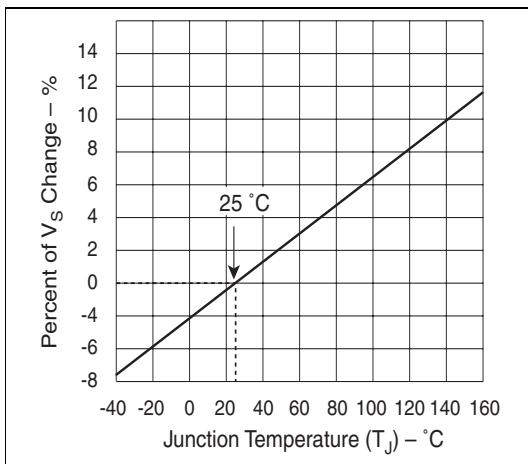

Normalized V_S Change versus Junction Temperature

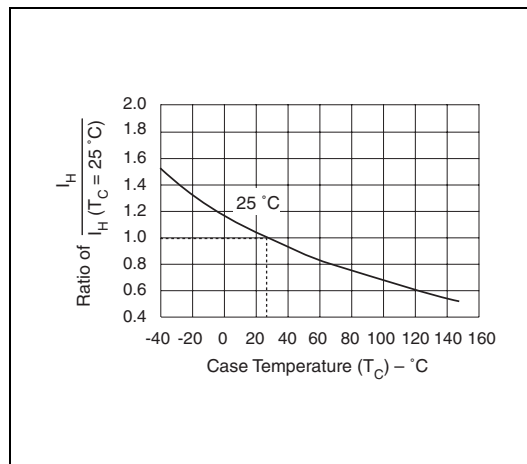

Normalized DC Holding Current versus Case Temperature

CATV and HFC SIDACtor Device



This *SIDACtor* device is a 1000 A solid state protection device offered in a TO-220 package. It protects equipment located in the severe surge environment of Community Antenna TV (CATV) applications.

Used in Hybrid Fiber Coax (HFC) applications, this device replaces the gas tube traditionally used for station protection, because a *SIDACtor* device has a much tighter voltage tolerance.

Electrical Parameters

Part Number *	V _{DRM} Volts	V _S Volts	V _T Volts	I _{DRM} μ Amps	I _S mAmps	I _T Amps	I _H mAmps	C _O pF
								Pins 1-3
P1400AD	120	160	3	5	800	2.2	50	200
P1800AD	170	220	5.5	5	800	2.2	50	150

* For surge ratings, see table below.

General Notes:

- All measurements are made at an ambient temperature of 25 °C. I_{PP} applies to -40 °C through +85 °C temperature range.
- I_{PP} is a repetitive surge rating and is guaranteed for the life of the product.
- Listed *SIDACtor* devices are bi-directional. All electrical parameters and surge ratings apply to forward and reverse polarities.
- V_{DRM} is measured at I_{DRM}.
- V_S is measured at 100 V/ μ s.
- Special voltage (V_S and V_{DRM}) and holding current (I_H) requirements are available upon request.
- Off-state capacitance is measured at 1 MHz with a 2 V bias and is a typical value.

Surge Ratings

Series	I _{PP} 8x20 μ s Amps	I _{PP} 10x1000 μ s Amps	I _{TSM} 60 Hz Amps	di/dt Amps/ μ s
D	1000	250	120	500

Thermal Considerations

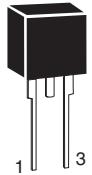
Package	Symbol	Parameter	Value	Unit
Modified TO-220 	T_J	Operating Junction Temperature Range	-40 to +150	$^{\circ}\text{C}$
	T_S	Storage Temperature Range	-65 to +150	$^{\circ}\text{C}$
	$R_{\theta JA}$	Thermal Resistance: Junction to Ambient	60	$^{\circ}\text{C/W}$

Data Sheets

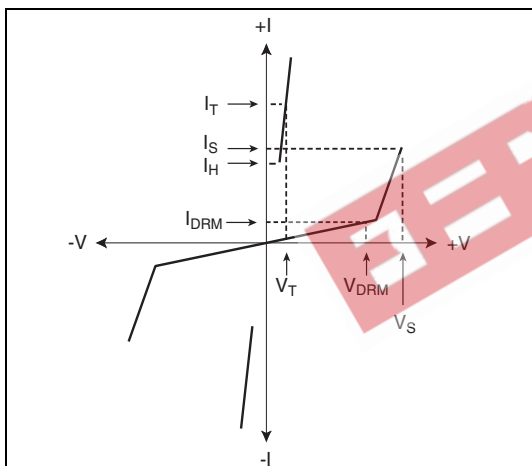

V-I Characteristics

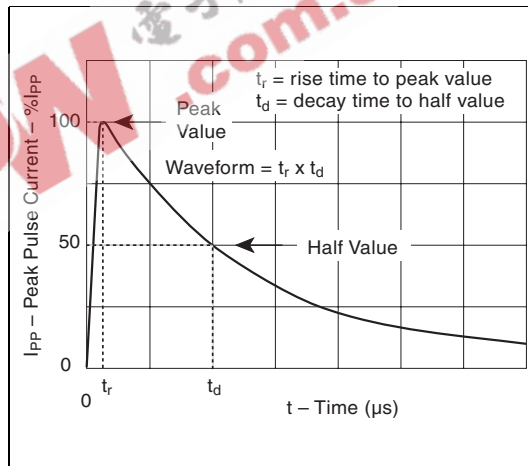

$t_r \times t_d$ Pulse Wave-form

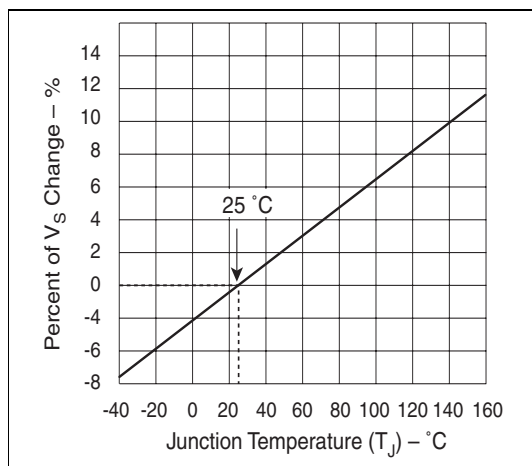

Normalized V_S Change versus Junction Temperature

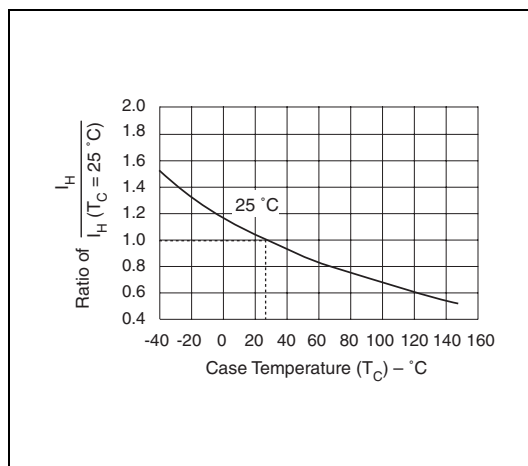

Normalized DC Holding Current versus Case Temperature

High Surge Current SIDACtor Device

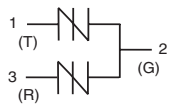

This SIDACtor device is a 1000 A solid state protection device offered in a TO-220 package. It protects equipment located in the severe surge environment of Community Antenna TV (CATV) applications.

This device can replace the gas tubes traditionally used for station protection because SIDACtor devices have much tighter voltage tolerances.

Electrical Parameters

Part Number *	V _{DRM} Volts	V _S Volts	V _T Volts	I _{DRM} μ Amps	I _S mAmps	I _T Amps	I _H mAmps	Co pF
								Pins 1-3
P6002AD	550	700	5.5	5	800	2.2	50	60

* For surge ratings, see table below.



Electrical Parameters

Part Number *	V _{DRM} Volts	V _S Volts	V _T Volts	I _{DRM} μ Amps	I _S mAmps	I _T Amps	I _H mAmps	Co pF
								Pins 1-3
P3100AD	280	360	5.5	5	800	2.2	120	115

* For surge ratings, see table below.

General Notes:

- All measurements are made at an ambient temperature of 25 °C. I_{PP} applies to -40 °C through +85 °C temperature range.
- I_{PP} is a repetitive surge rating and is guaranteed for the life of the product.
- Listed SIDACtor devices are bi-directional. All electrical parameters and surge ratings apply to forward and reverse polarities.
- V_{DRM} is measured at I_{DRM}.
- V_S is measured at 100 V/ μ s.
- Special voltage (V_S and V_{DRM}) and holding current (I_H) requirements are available upon request.
- Off-state capacitance is measured at 1 MHz with a 2 V bias and is a typical value.

Surge Ratings

Series	I _{PP} 8x20 μ s Amps	I _{PP} 10x1000 μ s Amps	I _{TSM} 60 Hz Amps	di/dt Amps/ μ s
D	1000	250	120	1000

Thermal Considerations

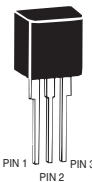
Package	Symbol	Parameter	Value	Unit
Modified TO-220 	T_J	Operating Junction Temperature Range	-40 to +150	$^{\circ}\text{C}$
	T_S	Storage Temperature Range	-65 to +150	$^{\circ}\text{C}$
	$R_{\theta JA}$	Thermal Resistance: Junction to Ambient	60	$^{\circ}\text{C/W}$

Note: P6002AD is shown. P3100AD has no center lead.

Data Sheets

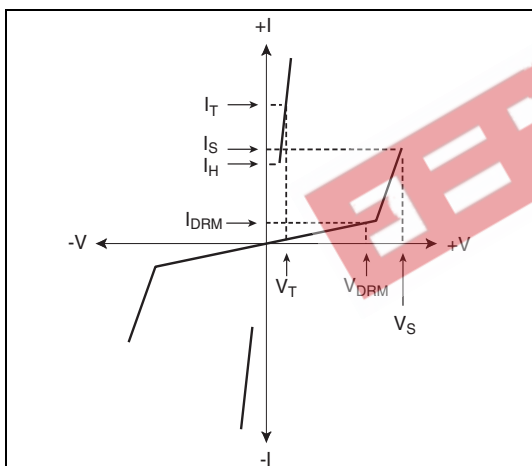

V-I Characteristics

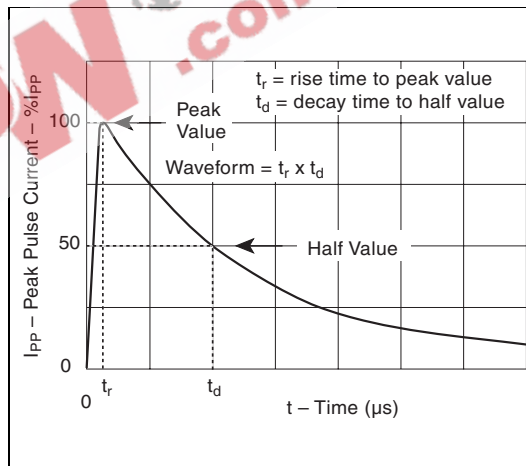

$t_r \times t_d$ Pulse Wave-form

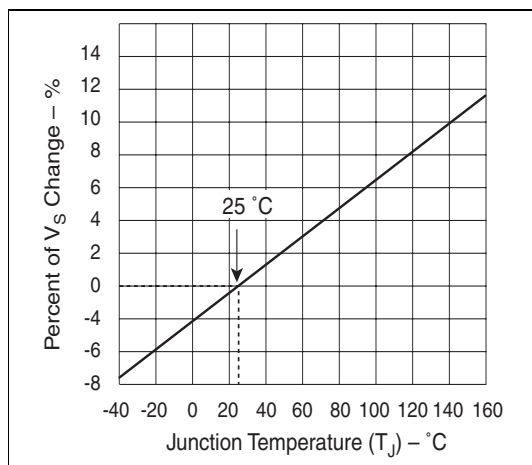

Normalized V_S Change versus Junction Temperature

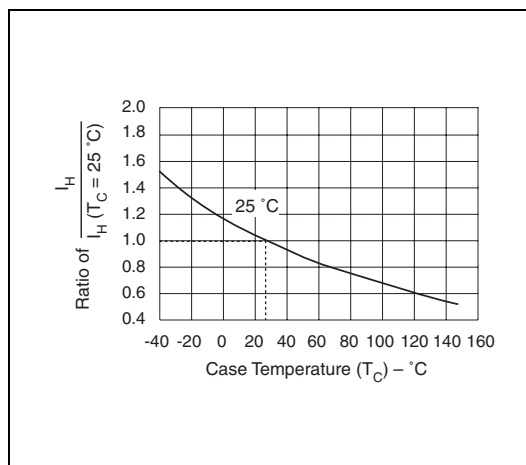

Normalized DC Holding Current versus Case Temperature

CATV Line Amplifiers/Power Inserters SIDACtor Device



This *SIDACtor* device is a 5000 A solid state protection device offered in a non-isolated TO-218 package. It protects equipment located in the severe surge environment of CATV (Community Antenna TV) applications.

In CATV line amplifiers and power inserters, this device can replace the gas tubes traditionally used for station protection because *SIDACtor* devices have much tighter voltage tolerances.

Electrical Parameters

Part Number *	V _{DRM} Volts	V _S Volts	V _T Volts	I _{DRM} μ Amps	I _S mAmps	I _T Amps **	I _H mAmps	C _O pF
P1900ME	140	220	4	5	800	2.2/25	50	750
P2300ME	180	260	4	5	800	2.2/25	50	750

* For surge ratings, see table below.

** I_T is a free air rating; heat sink I_T rating is 25 A.

General Notes:

- All measurements are made at an ambient temperature of 25 °C. I_{PP} applies to -40 °C through +85 °C temperature range.
- I_{PP} is a repetitive surge rating and is guaranteed for the life of the product.
- Listed *SIDACtor* devices are bi-directional. All electrical parameters and surge ratings apply to forward and reverse polarities.
- V_{DRM} is measured at I_{DRM}.
- V_S is measured at 100 V/ μ s.
- Special voltage (V_S and V_{DRM}) and holding current (I_H) requirements are available upon request.
- Off-state capacitance is measured at 1 MHz with a 2 V bias and is a typical value.

Surge Ratings

Series	I _{PP} 8x20 μ s Amps	I _{TSM} 60 Hz Amps	di/dt Amps/ μ s
E	5000	400	500

Thermal Considerations

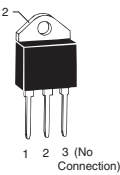
Package	Symbol	Parameter	Value	Unit
TO-218 	T_J	Operating Junction Temperature Range	-40 to +150	$^{\circ}\text{C}$
	T_S	Storage Temperature Range	-65 to +150	$^{\circ}\text{C}$
	T_C	Maximum Case Temperature	100	$^{\circ}\text{C}$
	$R_{\theta JC}^*$	Thermal Resistance: Junction to Case	1.7	$^{\circ}\text{C}/\text{W}$
	$R_{\theta JA}$	Thermal Resistance: Junction to Ambient	56	$^{\circ}\text{C}/\text{W}$

* $R_{\theta JC}$ rating assumes the use of a heat sink and on state mode for extended time at 25 A, with average power dissipation of 29.125 W.

Data Sheets

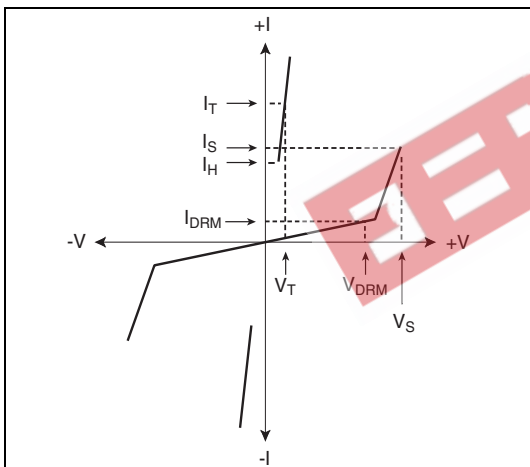

V-I Characteristics

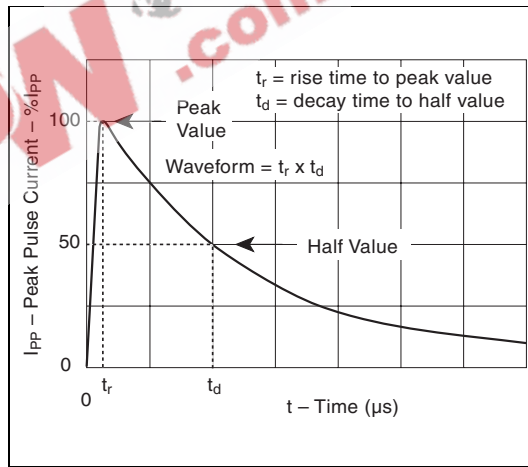

$t_r \times t_d$ Pulse Wave-form

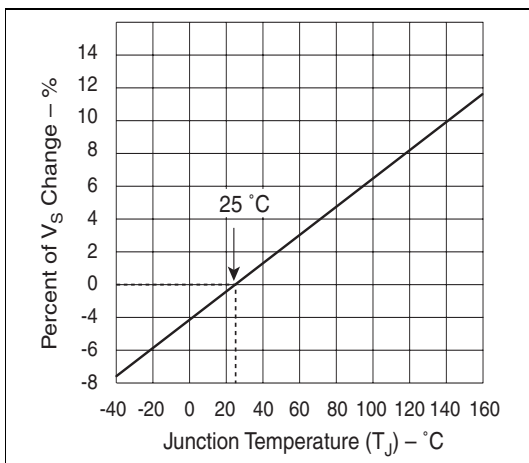

Normalized V_S Change versus Junction Temperature

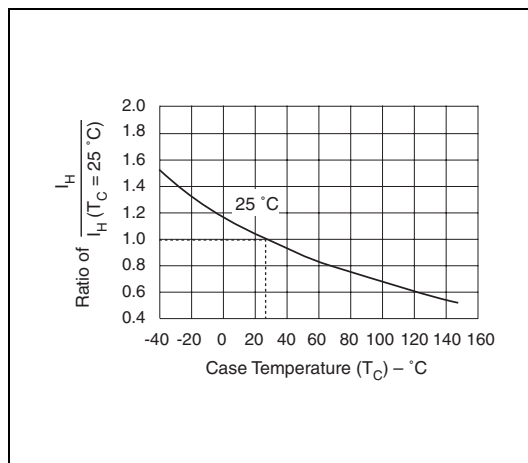

Normalized DC Holding Current versus Case Temperature

TeleLink Fuse

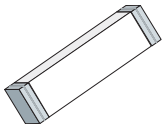

The *TeleLink* Surface Mount (SM) surge resistant fuse offers circuit protection without requiring a series resistor. When used in conjunction with the *SIDACtor* Transient Voltage Suppressor (TVS), the *TeleLink* SM fuse and the *SIDACtor* TVS provide a complete regulatory-compliant solution for standards such as GR 1089, TIA-968 (formerly known as FCC Part 68), UL 60950, and ITU K.20 and K.21. No series resistor is required for the F1250T and F1251T to comply with these standards.

Contact factory for enhanced K.20 and K.21 details.

Surge Ratings

TeleLink SM Fuse	I _{pp} 2x10 μs Amps	I _{pp} 10x160 μs Amps	I _{pp} 10x560 μs Amps	I _{pp} 10x1000 μs Amps
F0500T	not rated	75	45	35
F1250T	500	160	115	100
F1251T	500	160	115	100

Interrupting Values

TeleLink SM Fuse	Voltage Rating	Current Rating	I ² t Measured at DC Rated Voltage	Interrupting Rating			
				Voltage, Current	MIN	TYP	MAX
F0500T	250 V	500 mA	1.3 A ² s	600 V, 40 A	1 ms	2 ms	60 ms
F1250T	250 V	1.25 A	22.2 A ² s	600 V, 60 A *	1 ms	2 ms	60 ms
F1251T	250 V	2 A	30 A ² s	600 V, 60 A *	1 ms	2 ms	60 ms

* Interrupt test characterized at 50° to 70° phase angle. Phase angles approximating 90° may result in damage to the body of the fuse.

Notes:

- The *TeleLink* SM fuse is designed to carry 100% of its rated current for four hours and 250% of its rated current for one second minimum and 120 seconds maximum. Typical time is four to 10 seconds. For optimal performance, an operating current of 80% or less is recommended.
- I²t is a non-repetitive RMS surge current rating for a period of 16.7 ms.

Resistance Ratings

TeleLink SM Fuse	Typical Voltage Drop @ Rated Current	DC Cold Resistance	
		MIN	MAX
F0500T	0.471 V	0.420 Ω	0.640 Ω
F1250T	0.205 V	0.107 Ω	0.150 Ω
F1251T	0.110 V	0.050 Ω	0.100 Ω

Notes:

- Typical inductance ≅ 4 μH up to 500 MHz.
- Resistance changes 0.5% for every °C.
- Resistance is measured at 10% rated current.

Qualification Data

The F1250T and F1251T meet the following test conditions per GR 1089 **without** additional series resistance. However, in-circuit test verification is required. Note that considerable heating may occur during Test 4 of the Second Level AC Power Fault Test.

First Level Lightning Surge Test

Test	Surge Voltage Volts	Wave-form μ s	Surge Current Amps	Repetitions Each Polarity
1	± 600	10x1000	100	25
2	± 1000	10x360	100	25
3	± 1000	10x1000	100	25
4	± 2500	2x10	500	10
5	± 1000	10x360	25	5

Data Sheets

Second Level Lightning Surge Test

Test	Surge Voltage Volts	Wave-form μ s	Surge Current Amps	Repetitions Each Polarity
1	± 5000	2x10	500	1

First Level AC Power Fault Test

Test	Applied Voltage, 60 Hz V_{RMS}	Short Circuit Current Amps	Duration
1	50	0.33	15 min
2	100	0.17	15 min
3	200, 400, 600	1 at 600 V	60 applications, 1 s each
4	1000	1	60 applications, 1 s each
5	*	*	60 applications, 5 s each
6	600	0.5	30 s each
7	600	2.2	2 s each
8	600	3	1 s each
9	1000	5	0.5 s each

* Test 5 simulates a high impedance induction fault. For specific information, please contact Teccor Electronics.

Second Level AC Power Fault Test for Non-Customer Premises Equipment

Test	Applied Voltage, 60 Hz V_{RMS}	Short Circuit Current Amps	Duration
1	120, 277	30	30 min
2	600	60	5 s
3	600	7	5 s
4	100-600	2.2 at 600 V	30 min

Notes:

- Power fault tests equal or exceed the requirements of UL 60950 3rd edition.
- Test 4 is intended to produce a maximum heating effect. Temperature readings can exceed 150 °C.
- Test 2 may be dependent on the closing angle of the voltage source. Fuse is characterized at 50° to 70°. Closing angles approximating 90° may result in damage to the body of the fuse.
- Use caution when routing internal traces adjacent to the F1250T and F1251T.

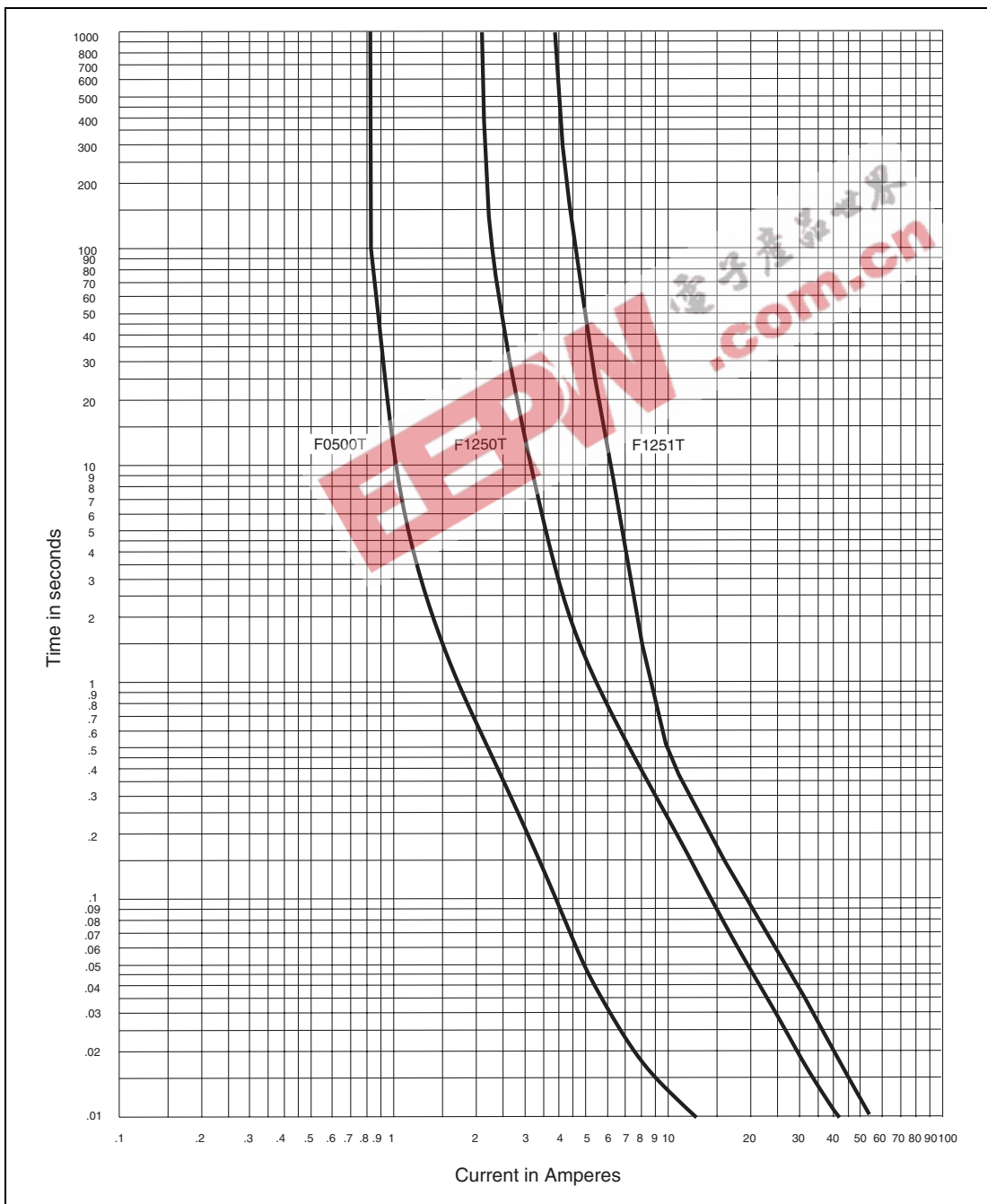

Time Current Curve

Temperature Derating Curve

Operating temperature is -55 °C to +125 °C with proper correction factor applied.

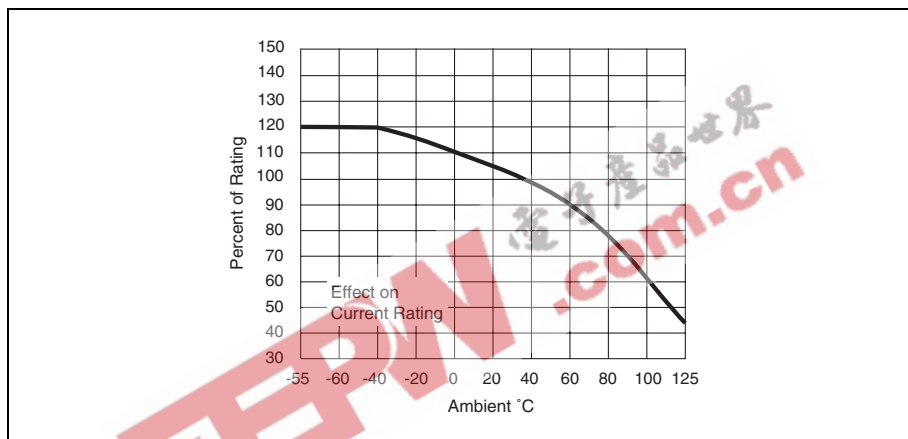

Chart of Correction Factor

Maximum Temperature Rise

TeleLink Fuse	Temperature Reading
F0500T	≤75 °C (167 °F) *
F1250T	≤75 °C (167 °F) *
F1251T	≤75 °C (167 °F) *

* Higher currents and PCB layout designs can affect this parameter.

Notes:

- Readings are measured at rated current after temperature stabilizes
- The F1250T meets the requirements of UL 248-14. However, board layout, board trace widths, and ambient temperature values can cause higher than expected rises in temperature. During UL testing, the typical recorded heat rise for the F1250T at 2.2 A was 120 °C.

Package Symbolization

Marking	F0500T	F1250T	F1251T	Manufactured in USA	Manufactured in Taiwan
FU	F			U	
FT	F				T
JU		J		U	
JT		J			T
NU			N	U	
NT			N		T

NOTES

EEPW 电子产品世界
.com.cn

3

Reference Designs

This section offers specific examples of how *SIDACTor* devices can be used to ensure long-term operability of protected equipment and uninterrupted service during transient electrical activity. For additional line interface protection circuits, see "Regulatory Compliant Solutions" on page 4-34.

Customer Premises Equipment (CPE).....	3-3
High Speed Transmission Equipment	3-7
ADSL Circuit Protection	3-7
HDSL Circuit Protection	3-8
ISDN Circuit Protection	3-10
Pair Gain Circuit Protection	3-11
T1/E1 Circuit Protection	3-14
Additional T1 Design Considerations	3-16
T3 Protection.....	3-16
Analog Line Cards	3-17
PBX Systems	3-25
CATV Equipment	3-26
Primary Protection	3-29
Secondary Protection	3-31
Triac Protection	3-33
Data Line Protectors	3-34
LAN / WAN Protectors	3-35
10Base-T Protection	3-35
100Base-T Protection	3-36

Reference Designs

Note: The circuits referenced in this section represent typical interfaces used in telecommunications equipment. *SIDACTor* devices are not the sole components required to pass applicable regulatory requirements such as UL 60950, GR 1089, or TIA-968 (formerly known as FCC Part 68), nor are these requirements specifically directed at *SIDACTor* devices.

EEPW 电子产品世界
 .com.cn

Customer Premises Equipment (CPE)

CPE is defined as any telephone terminal equipment which resides at the customer's site and is connected to the Public Switched Telephone Network (PSTN). Telephones, modems, caller ID adjunct boxes, PBXs, and answering machines are all considered CPE.

Protection Requirements

CPE should be protected against overvoltages that can exceed 800 V and against surge currents up to 100 A. In Figure 3.1 through Figure 3.6, *SIDACtor* devices were chosen because their associated peak pulse current (I_{PP}) rating is sufficient to withstand the lightning immunity test of TIA-968 (formerly known as FCC Part 68) without the additional use of series line impedance. Likewise, the fuse shown in Figure 3.1 through Figure 3.6 was chosen because the amps²time (I^2t) rating is sufficient to withstand the lightning immunity tests of TIA-968 without opening, but low enough to pass UL power cross conditions.

The following regulatory requirements apply:

- TIA-968 (formerly known as FCC Part 68)
- UL 60950

All CPE intended for connection to the PSTN must be registered in compliance with TIA-968. Also, because the National Electric Code mandates that equipment intended for connection to the telephone network be listed for that purpose, consideration should be given to certifying equipment with an approved safety lab such as Underwriters Laboratories.

CPE Reference Circuits

Figure 3.1 through Figure 3.6 show examples of interface circuits which meet all applicable regulatory requirements for CPE. The P3100SB and P3100EB are used in these circuits because the peak off-state voltage (V_{DRM}) is greater than the potential of a Type B ringer superimposed on a POTS (plain old telephone service) battery.

$$150 V_{RMS} \sqrt{2} + 56.6 V_{PK} = 268.8 V_{PK}$$

Note that the circuits shown in Figure 3.1 through Figure 3.6 provide an operational solution for TIA-968 (formerly known as FCC Part 68). However TIA-968 allows CPE designs to pass non-operationally as well.

For a non-operational solution, coordinate the I_{PP} rating of the *SIDACtor* device and the I^2t rating of the fuse so that (1) both will withstand the Type B surge, and (2) during the Type A surge, the fuse will open. (See Table 5.1, Surge Rating Correlation to Fuse Rating on page 5-8.)

Note: For alternative line interface protection circuits, see "Regulatory Compliant Solutions" on page 4-34.

Customer Premises Equipment (CPE)

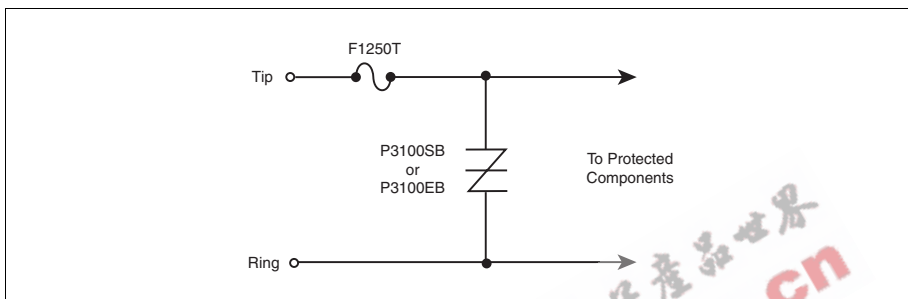

Figure 3.1 Basic CPE Interface

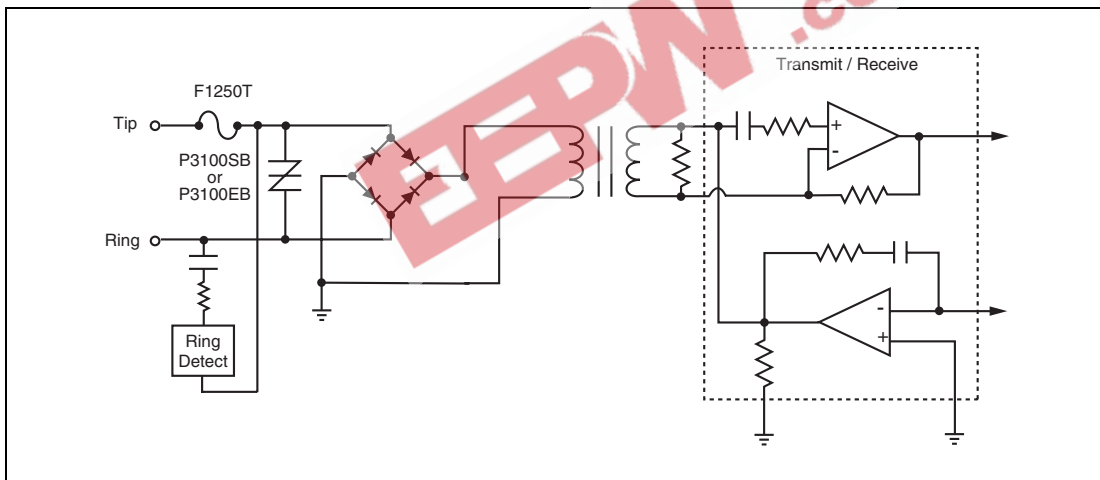

Figure 3.2 Transformer Coupled Tip and Ring Interface

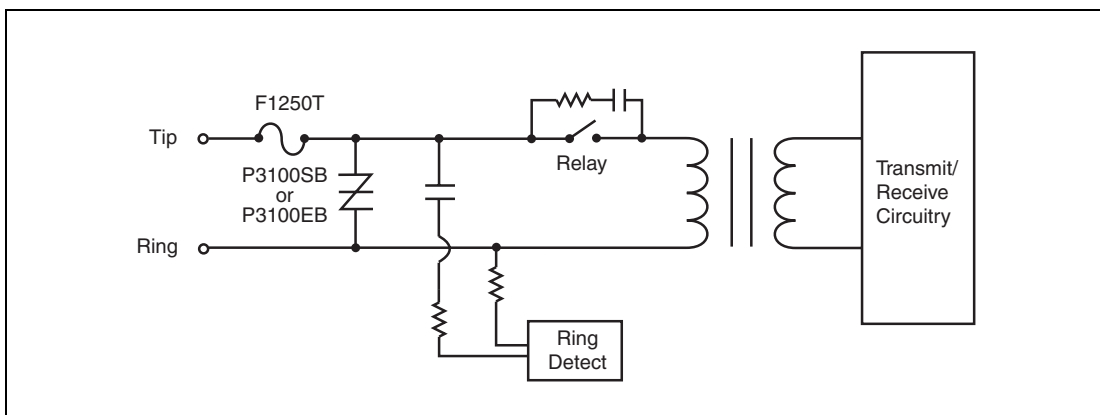

Figure 3.3 Modem Interface

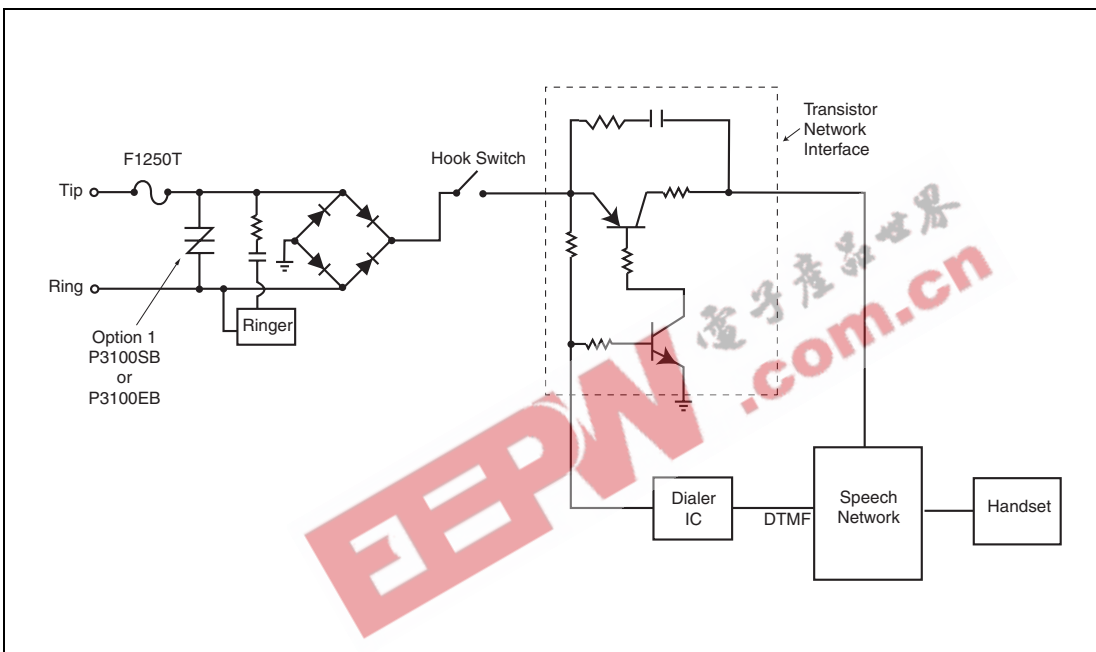

Figure 3.4 CPE Transistor Network Interface — Option 1

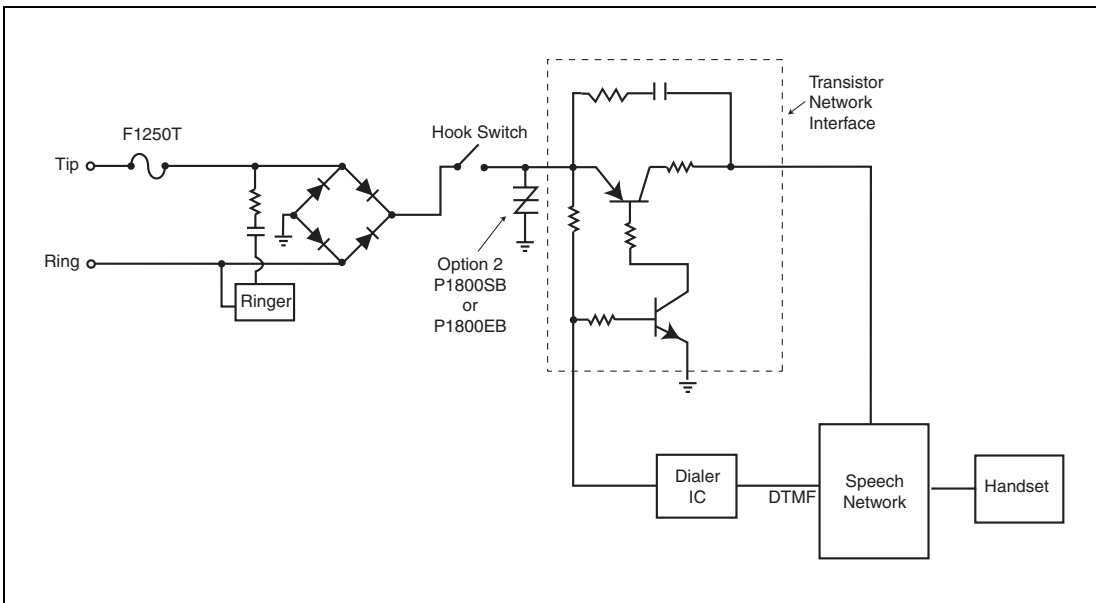

Figure 3.5 CPE Transistor Network Interface — Option 2

Reference Designs

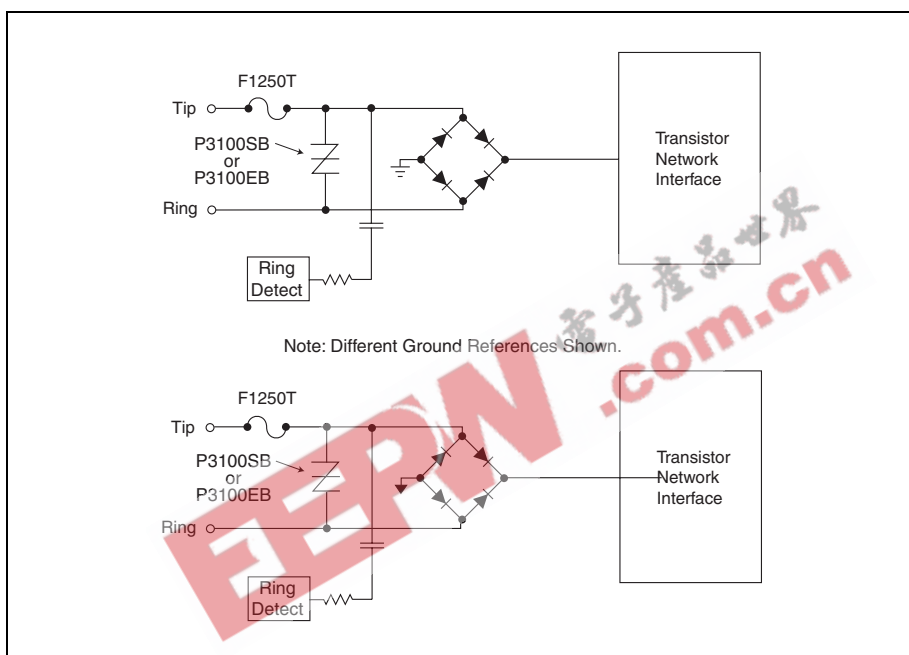

Figure 3.6 Two-line CPE Interface

High Speed Transmission Equipment

High speed transmission equipment encompasses a broad range of transmission protocols such as T1/E1, xDSL, and ISDN. Transmission equipment is located at the central office, customer premises, and remote locations.

Protection Requirements

Transmission equipment should be protected against overvoltages that can exceed 2500 V and surge currents up to 500 A. In Figure 3.7 through Figure 3.17, *SIDACTor* devices were chosen because their associated peak pulse current (I_{PP}) rating is sufficient to withstand the lightning immunity tests of GR 1089 without the additional use of series line impedance. Likewise, the fuse shown in Figure 3.7 through Figure 3.17 was chosen because the amps^2time (I^2t) rating is sufficient to withstand the lightning immunity tests of GR 1089, but low enough to pass GR 1089 current limiting protector test and power cross conditions (both first and second levels).

The following regulatory requirements apply:

- TIA-968 (formerly known as FCC Part 68)
- GR 1089-CORE
- ITU-T K.20/K.21
- UL 60950

Most transmission equipment sold in the US must adhere to GR 1089. For Europe and other regions, ITU-T K.20/K.21 is typically the recognized standard.

ADSL Circuit Protection

Asymmetric Digital Subscriber Lines (ADSLs) employ transmission rates up to 6.144 Mbps from the Central Office Terminal (COT) to the Remote Terminal (RT) and up to 640 kbps from the RT to the COT at distances up to 12,000 feet. (Figure 3.7)

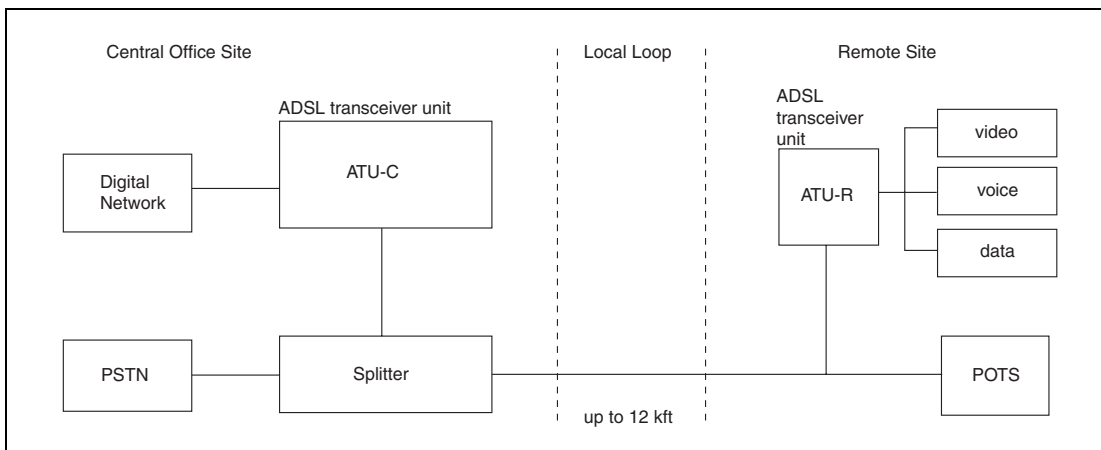

Figure 3.7 ADSL Overview

Protection Circuitry

Longitudinal protection was not used at either the ADSL Transceiver Unit – Central Office (ATU-C) interface or the ADSL Transceiver Unit – Remote (ATU-R) interface due to the absence of earth ground connections. (Figure 3.8) In both instances, the P3500SC MC *SIDACTor* device and the F1250T *TeleLink* fuse provide metallic protection. For ATUs not isolated from earth ground, reference the HDSL protection topology.

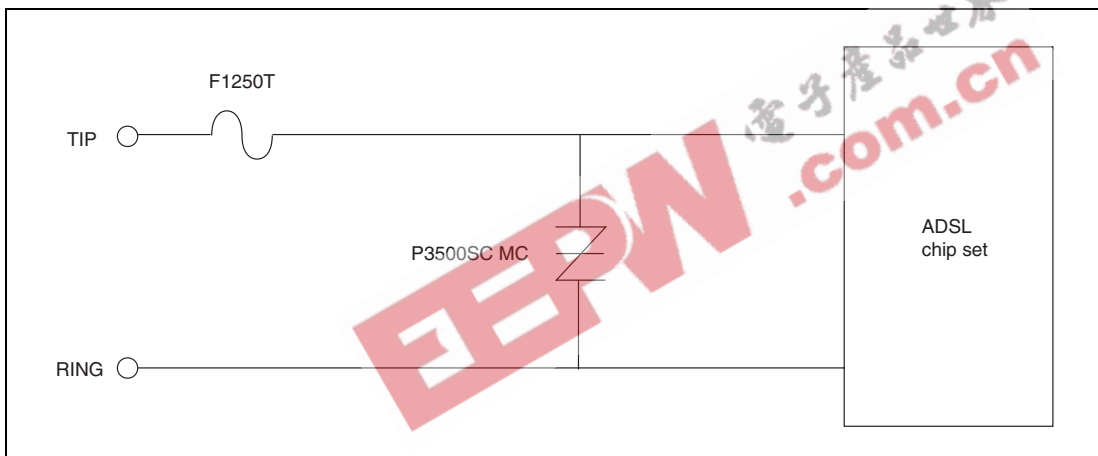

Figure 3.8 ADSL Protection

Component Selection

The P3500SC MC *SIDACTor* device and F1250T *TeleLink* fuse were chosen to protect the ATUs because both components meet GR 1089 surge immunity requirements without the use of additional series resistance. Although the P3100 series *SIDACTor* device may be used to meet current ANSI specifications, Teccor recommends the P3500 series to avoid interference with the $20 V_{P-P} \times DSL$ signal on a 150 V rms ringing signal superimposed on a 56.5 V battery.

HDSL Circuit Protection

HDSL (High-bit Digital Subscriber Line) is a digital line technology that uses a 1.544 Mbps (T1 equivalent) transmission rate for distances up to 12,000 feet, eliminating the need for repeaters. The signaling levels are a maximum of ± 2.5 V while loop powering is typically under 190 V. (Figure 3.9)

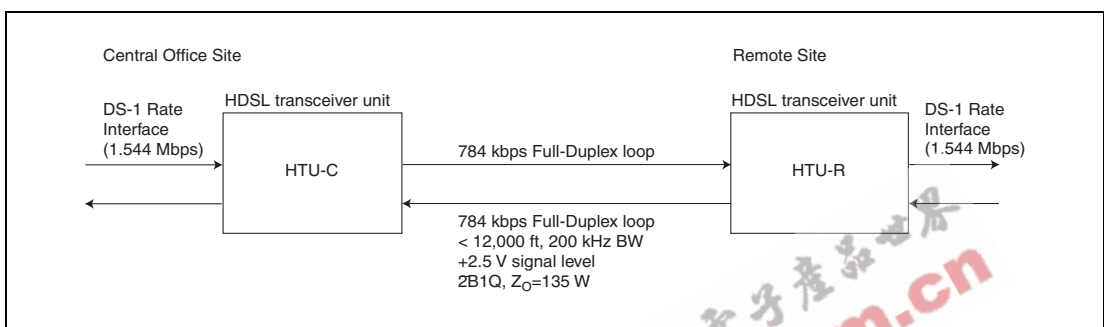

Figure 3.9 HDSL Overview

Protection Circuitry

Longitudinal protection is required at both the HDSL Transceiver Unit – Central Office (HTU-C) and HDSL Transceiver Unit – Remote (HTU-R) interfaces because of the ground connection used with loop powering. Two P2300SC MC SIDACTor devices provide overvoltage protection and two F1250T TeleLink fuses (one on Tip, one on Ring) provide overcurrent protection. (Figure 3.10) For the transceiver side of the coupling transformer, additional overvoltage protection is provided by the P0080SA SIDACTor device. The longitudinal protection on the primary coil of the transformer is an additional design consideration for prevention of EMI coupling and ground loop issues.

Reference Designs

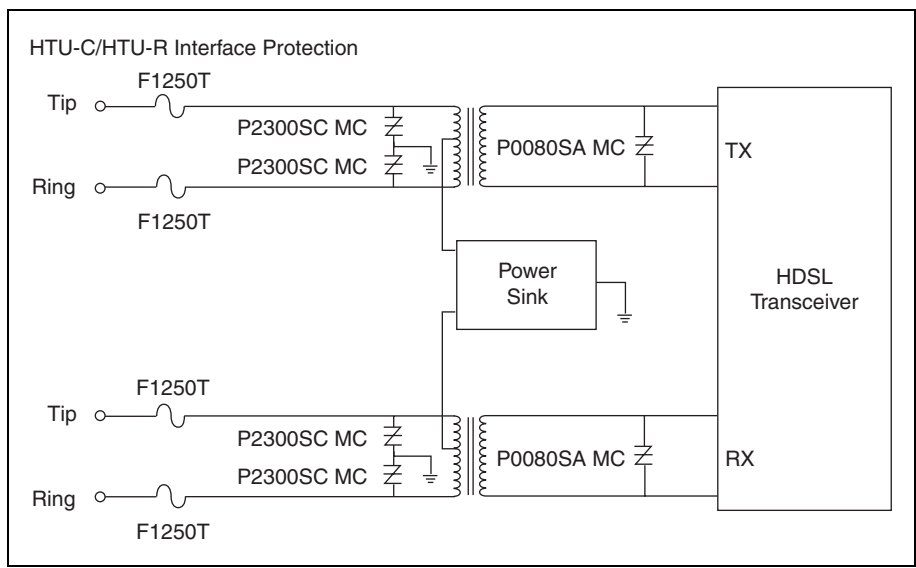

Figure 3.10 HDSL Protection

Component Selection

The P2300SC MC *SIDACTor* device and the F1250T *TeleLink* fuse were chosen because both components meet GR 1089 surge immunity requirements without the use of additional series resistance. The P2300SC MC voltage rating was selected to ensure loop powering up to 190 V. For loop powering greater than 190 V, consider the P2600SC MC. The P0080SA MC *SIDACTor* device was chosen to eliminate any sneak voltages that may appear below the voltage rating of the P2300SC MC.

ISDN Circuit Protection

Integrated Services Digital Network (ISDN) circuits require protection at the Network Termination Layer 1 (NT1) U-interface and at the Terminating Equipment (TE) or Terminating Adapter (TA) S/T interface. Signal levels at the U-interface are typically ± 2.5 V; however, with sealing currents and maintenance loop test (MLT) procedures, voltages approaching 150 V rms can occur. (Figure 3.11)

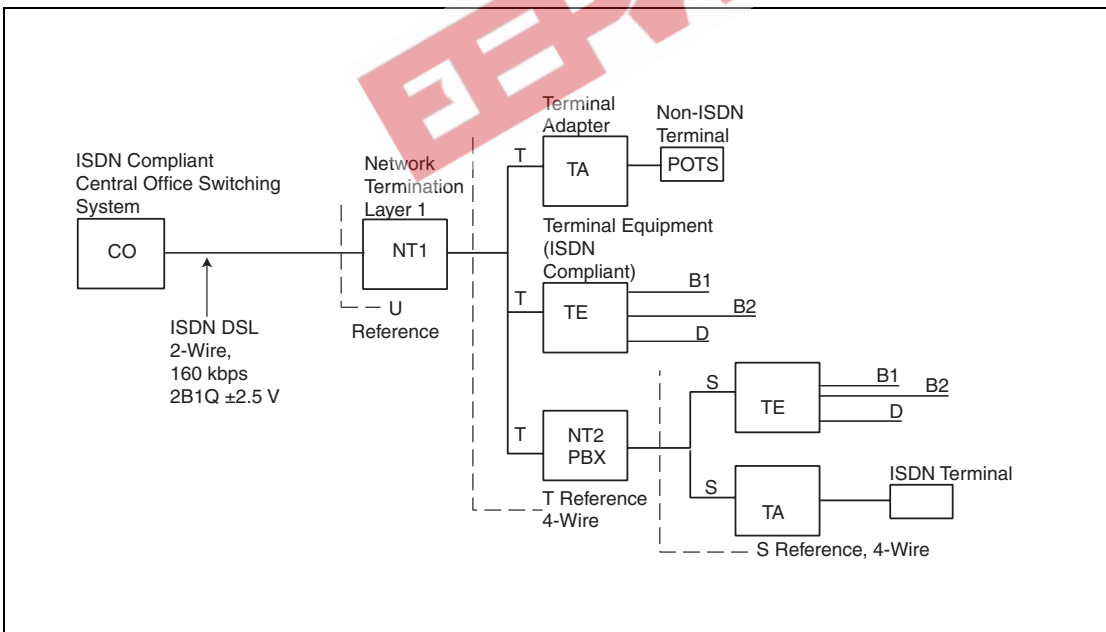

Figure 3.11 ISDN Overview

Protection Circuitry

Longitudinal protection was not used at either the U- or the TA/TE-interface due to the absence of an earth-to-ground connection. (Figure 3.12) At the U-interface, the P2600SC MC *SIDACTor* device and F1250T *TeleLink* fuse provide metallic protection, while the TA/TE-interface uses the P0640SC MC *SIDACTor* device and F1250T *TeleLink* fuse. Figure 3.12 also shows interfaces not isolated from earth ground.

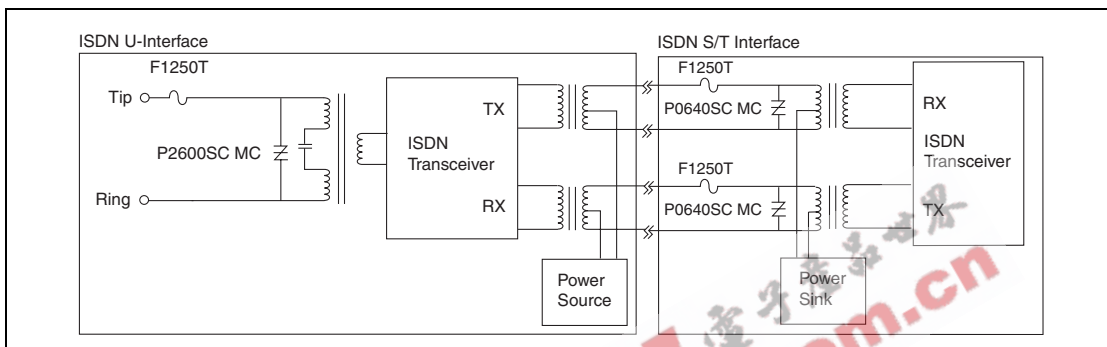

Figure 3.12 ISDN Protection

Component Selection

The "SC MC" SIDACtor devices and F1250T TeleLink fuse were chosen because these components meet GR 1089 surge immunity requirements without the use of additional series resistance. An MC is chosen to reduce degradation of data rates. The P2600SC MC voltage rating was selected to ensure coordination with MLT voltages that can approach 150 V rms. The voltage rating of the P0640SC MC was selected to ensure coordination with varying signal voltages.

Pair Gain Circuit Protection

A digital pair gain system differs from an ISDN circuit in that ring detection, ring trip, ring forward, and off-hook detection are carried within the 64 kbps bit stream for each channel rather than using a separate D channel. The pair gain system also uses loop powering from 10 V up to 145 V with a typical maximum current of 75 mA. (Figure 3.13)

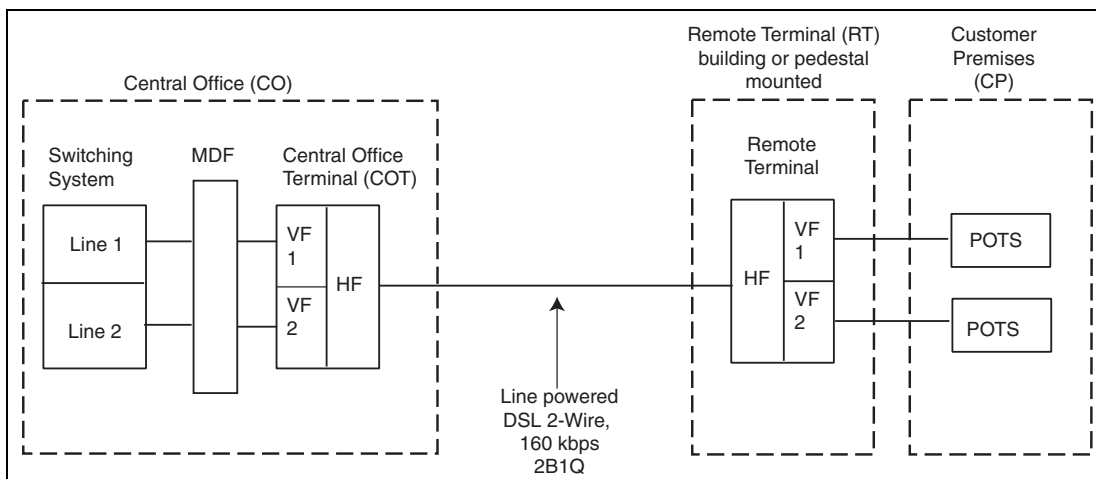

Figure 3.13 Pair Gain Overview

Protection Circuitry

Longitudinal protection is required at the Central Office Terminal (COT) interface because of the ground connection used with loop powering. (Figure 3.14) Two P1800SC MC *SIDACTor* devices provide overvoltage protection and two F1250T *TeleLink* fuses (one on Tip, one on Ring) provide overcurrent protection. For the U-interface side of the coupling transformer, the illustration shows the P0080SA MC *SIDACTor* device used for additional overvoltage protection.

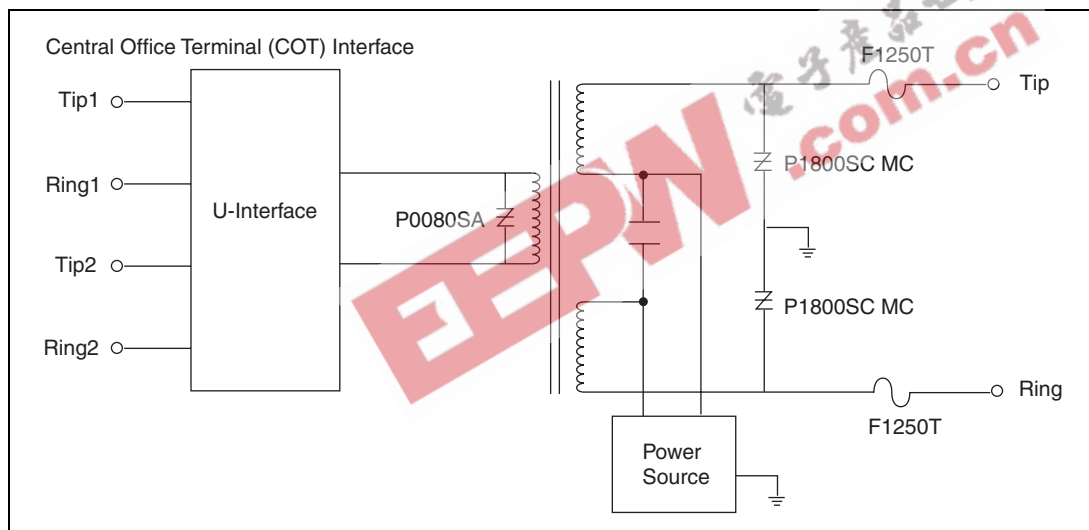

Figure 3.14 Pair Gain COT Protection

For Customer Premises (CP) and Remote Terminal (RT) interfaces where an earth ground connection is not used, only metallic protection is required. Figure 3.15 shows metallic protection satisfied using a single P3100SC MC across Tip and Ring and a single F1250T on either Tip or Ring to satisfy metallic protection.

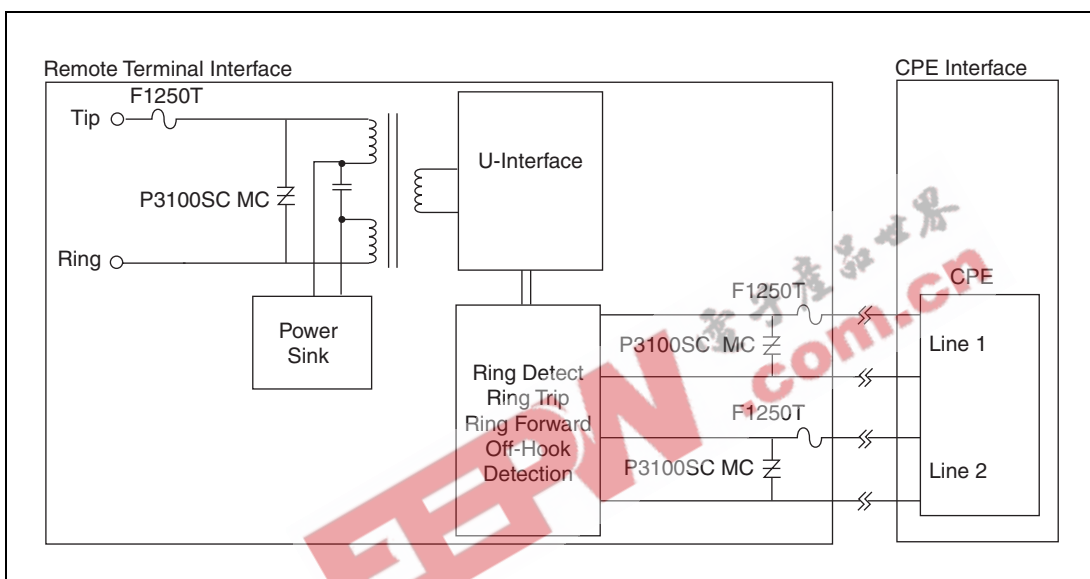

Figure 3.15 Pair Gain RT Protection

Component Selection

The "SC MC" SIDACTor device and F1250T TeleLink fuse were chosen because both components meet GR 1089 surge immunity requirements without the use of additional series resistance. An MC is chosen to reduce degradation of data rates. The voltage rating of the P1800SC MC was selected to ensure coordination with loop powering up to 150 V. The voltage rating of the P3100SC MC was selected to ensure coordination with POTS ringing and battery voltages.

T1/E1 Circuit Protection

T1/E1 networks offer data rates up to 1.544 Mbps (2.058 for E1) on four-wire systems. Signal levels on the transmit (TX) pair are typically between 2.4 V and 3.6 V while the receive (RX) pair could go as high as 12 V. Loop powering is typically ± 130 V at 60 mA, although some systems can go as high as 150 V. (Figure 3.16)

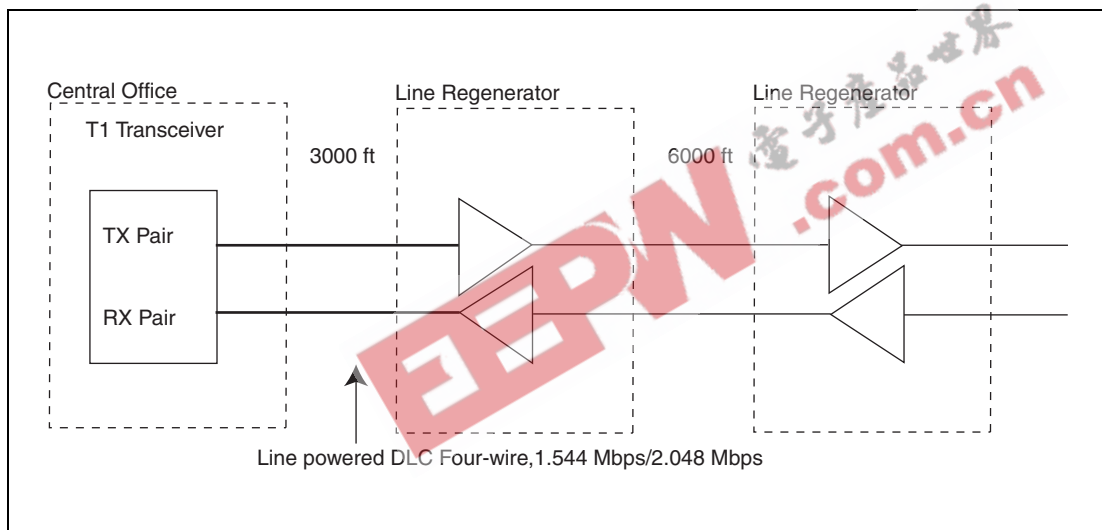

Figure 3.16 T1/E1 Overview

Protection Circuitry

Longitudinal protection is required at the Central Office Terminal (COT) interface because of the ground connection used with loop powering. (Figure 3.17) Two P1800SC MC *SIDACtor* devices provide overvoltage protection and two F1250T *TeleLink* fuses (one on Tip, one on Ring) provide overcurrent protection. The P1800SC MC device is chosen because its V_{DRM} is compliant with TIA-968 regulations, Section 4.4.5.2, "Connections with protection paths to ground." These regulations state:

Approved terminal equipment and protective circuitry having an intentional dc conducting path to earth ground for protection purposes at the leakage current test voltage that was removed during the leakage current test of section 4.3 shall, upon its replacement, have a 50 Hz or 60 Hz voltage source applied between the following points:

- Simplex telephone connections, including Tip and Ring, Tip-1 and Ring-1, E&M leads and auxiliary leads
- Earth grounding connections

The voltage shall be gradually increased from zero to 120 V rms for approved terminal equipment, or 300 V rms for protective circuitry, then maintained for one minute. The current between (a) and (b) shall not

exceed 10 mA_{PK} at any time. As an alternative to carrying out this test on the complete equipment or device, the test may be carried out separately on components, subassemblies, and simulated circuits, outside the unit, provided that the test results would be representative of the results of testing the complete unit.

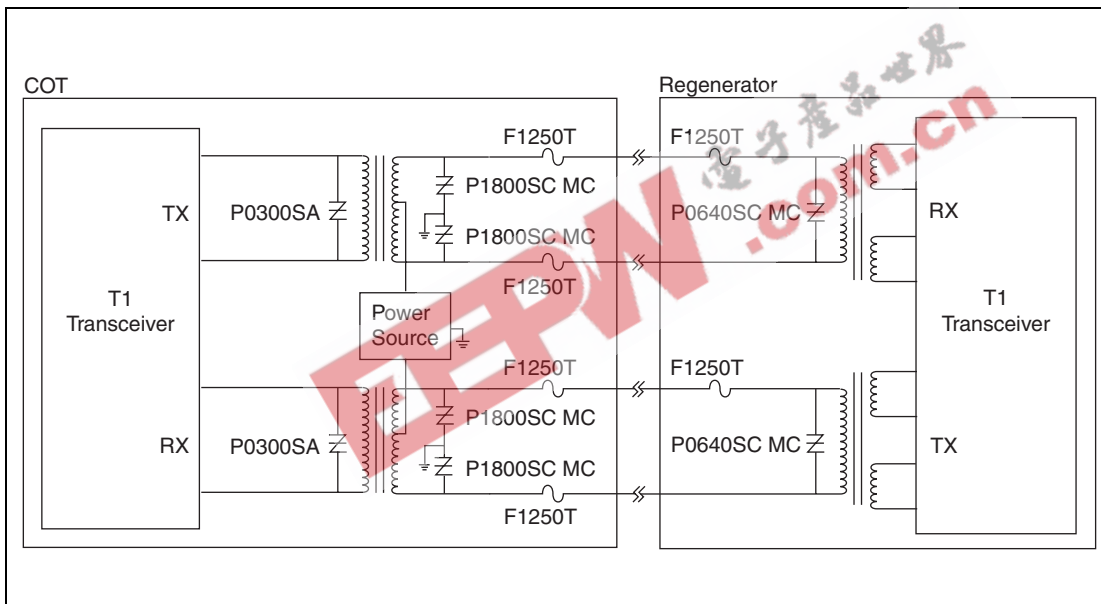

Reference Designs

Figure 3.17 T1/E1 Protection

The peak voltage for 120 V rms is 169.7 V. The minimum stand-off voltage for the P1800 is 170 V, therefore, the P1800SC MC will pass the test in Section 4.4.5.2 by not allowing 10 mA of current to flow during the application of this test voltage.

For the transceiver side of the coupling transformer, additional overvoltage protection is shown in Figure 3.17 using the P0300SA SIDACTor device. When an earth ground connection is not used, only metallic protection is required. Metallic protection is satisfied using a single P0640SC MC SIDACTor device across Tip and Ring and a single F1250T TeleLink fuse on either Tip or Ring.

Component Selection

The "SC MC" SIDACTor device and F1250T TeleLink fuse were chosen because these components meet GR 1089 surge immunity requirements without the use of additional series resistance. An MC is chosen to reduce degradation of data rates. The voltage rating of the P1800SC MC was selected to ensure loop powering up to 150 V. The voltage rating of the P0640SC MC was selected to ensure coordination with varying voltage signals.

Additional T1 Design Considerations

A T1 application can be TIA-968 approved as two different possible device types. An XD device means an external CSU is used and the unit does not have to meet the TIA-968 environmental test conditions, but it must connect only behind a separately registered DE device. This XD equipment does not have to meet the T1 pulse template requirements. If not classified as an XD device, then typically the application must adhere to TIA-968 environmental test conditions.

T3 Protection

The capacitance across the pair of wires = $(D1 \parallel D2) + P0640EC/SC$. The diode capacitance is approximately $(10 \text{ pF} \parallel 10 \text{ pF}) 20 \text{ pF}$. Then adding the capacitive effect of the P0640EC/SCMC, which is typically 60 pF, the total capacitance across the pair of wires is approximately 15 pF. The MUR 1100E diodes are fast-switching diodes that will exhibit this level of capacitance. MURS160T3 is a surface mount equivalent. (Figure 3.18)

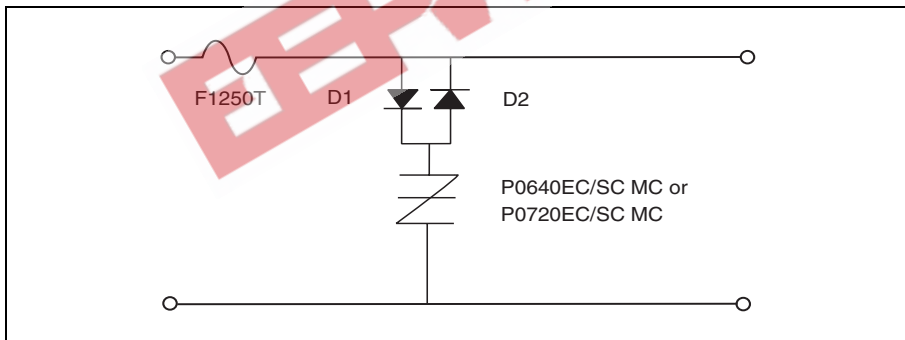

Figure 3.18 T3 Protection

Alternately, the advanced P0642SA exhibits very low capacitance and can be used as a stand-alone device.

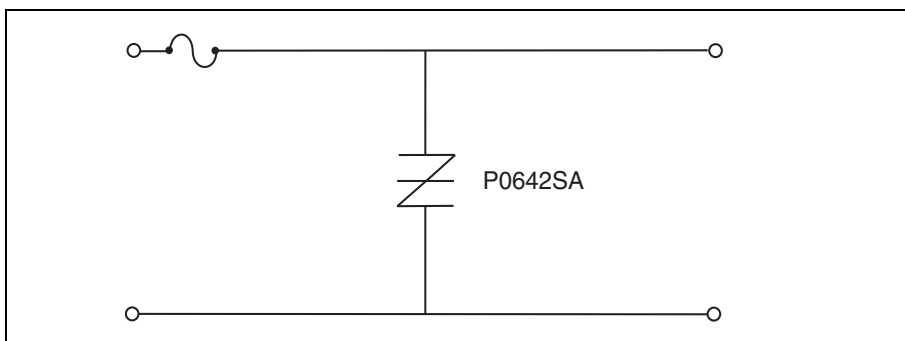

Figure 3.19 Alternate T3 Protection

Analog Line Cards

Given that line cards are highly susceptible to transient voltages, network hazards such as lightning and power cross conditions pose a serious threat to equipment deployed at the central office and in remote switching locations. To minimize this threat, adequate levels of protection must be incorporated to ensure reliable operation and regulatory compliance.

Protection Requirements

When designing overvoltage protection for analog line cards, it is often necessary to provide both on-hook (relay) and off-hook (SLIC) protection. This can be accomplished in two stages, as shown in Figure 3.20.

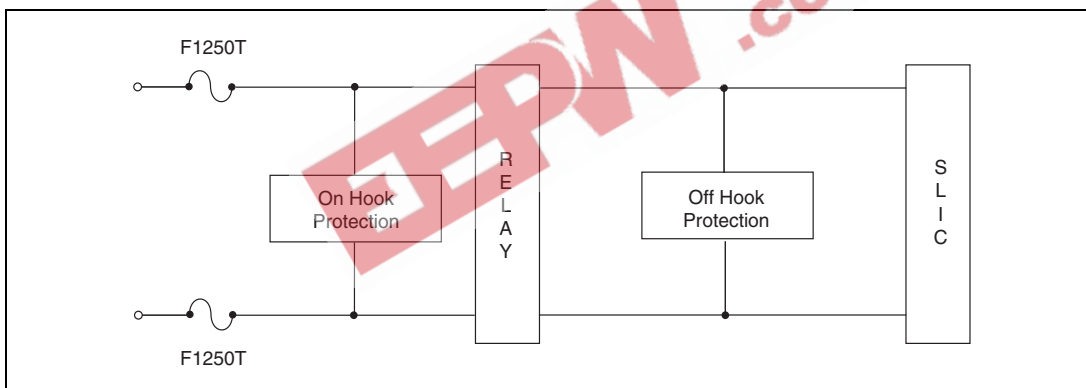

Figure 3.20 SLIC Overview

The following regulatory requirements may apply:

- GR 1089-CORE
- ITU-T K.20/K.21
- UL 60950
- TIA-968 (formerly known as FCC Part 68)

On-Hook (Relay) Protection

On-hook protection is accomplished by choosing a *SIDACtor* device that meets the following criteria to ensure proper coordination between the ring voltage and the maximum voltage rating of the relay to be protected.

$$V_{\text{DRM}} > V_{\text{BATT}} + V_{\text{RING}}$$

$$V_{\text{S}} \leq V_{\text{Relay Breakdown}}$$

This criterion is typically accomplished using two P2600S_ *SIDACtor* devices (where _ denotes the surge current rating) connected from Tip to Ground and Ring to Ground. However, for applications using relays such as an LCAS (Line Card Access Switch), consider the P1200S_ from Tip to Ground and the P2000S_ from Ring to Ground.

Off-Hook (SLIC) Protection

Off-hook protection is accomplished by choosing a *SIDACTor* device that meets the following criteria to ensure proper coordination between the supply voltage (V_{REF}) and the maximum voltage rating of the SLIC to be protected.

$$V_{DRM} > V_{REF}$$

$$V_S \leq V_{SLIC \text{ Breakdown}}$$

This criterion can be accomplished in a variety of different ways. For applications using an external ring generator and a fixed battery voltage, two P0641S_ *SIDACTor* devices (P0721S_, P0901S_, or P1101S_ depending on the value of V_{REF}) are used — one Tip to Ground, one Ring to Ground. For applications using a ring-generating SLIC such as AMD's Am79R79, the B1XX0C_ or B1XX1U_ can be used.

I_{PP} Selection

The I_{PP} of the *SIDACTor* device must be greater than or equal to the maximum available surge current ($I_{PK(available)}$) of the applicable regulatory requirements. Calculate the maximum available surge current by dividing the peak surge voltage supplied by the voltage generator (V_{PK}) by the total circuit resistance (R_{TOTAL}). The total circuit resistance is determined by adding the source resistance (R_S) of the surge generator to the series resistance in front of the *SIDACTor* device on Tip and Ring (R_{TIP} and R_{RING}).

$$I_{PP} \geq I_{PK(available)}$$

$$I_{PK(available)} = V_{PK} / R_{TOTAL}$$

For metallic surges:

$$R_{TOTAL} = R_S + R_{TIP} + R_{RING}$$

For longitudinal surges:

$$R_{TOTAL} = R_S + R_{TIP}$$

$$R_{TOTAL} = R_S + R_{RING}$$

Reference Diagrams

Figure 3.21 shows the use of Teccor's "SC" rated *SIDACTor* devices and the F1250T *TeleLink* fuse to meet the surge immunity requirements of GR 1089. Teccor's P1200SC and P2000SC, specifically designed to protect Agere Systems (formerly Lucent Microelectronics) Line Card Access Switch (LCAS), provide on-hook protection. Two P0641SCs provide off-hook protection. Any additional series resistance is absent because the "C" series *SIDACTor* device and F1250T *TeleLink* fuse are designed to withstand GR 1089 surges without the aid of additional components such as line feed resistors and PTCs.

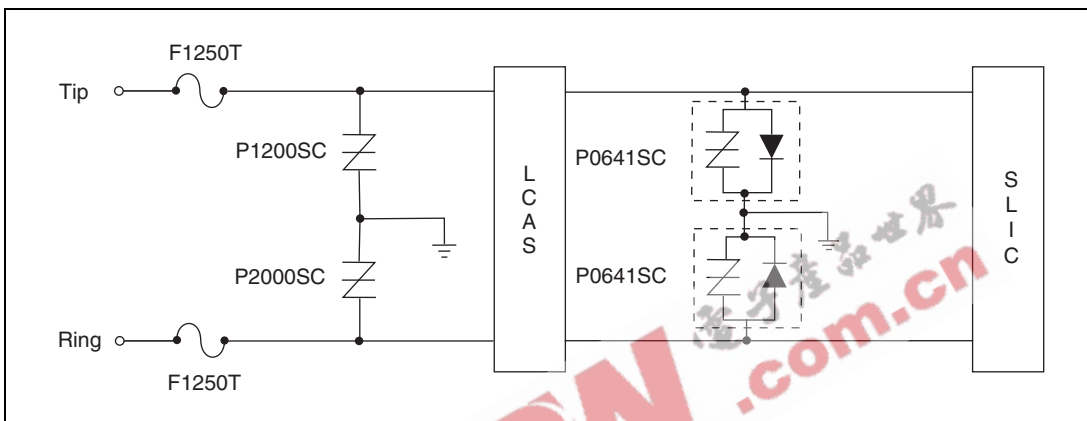

Figure 3.21 SLIC Protection for LCAS

Figure 3.22 illustrates uses of asymmetrical SIDACTor protection for overvoltage conditions and the F1250T for overcurrent conditions.

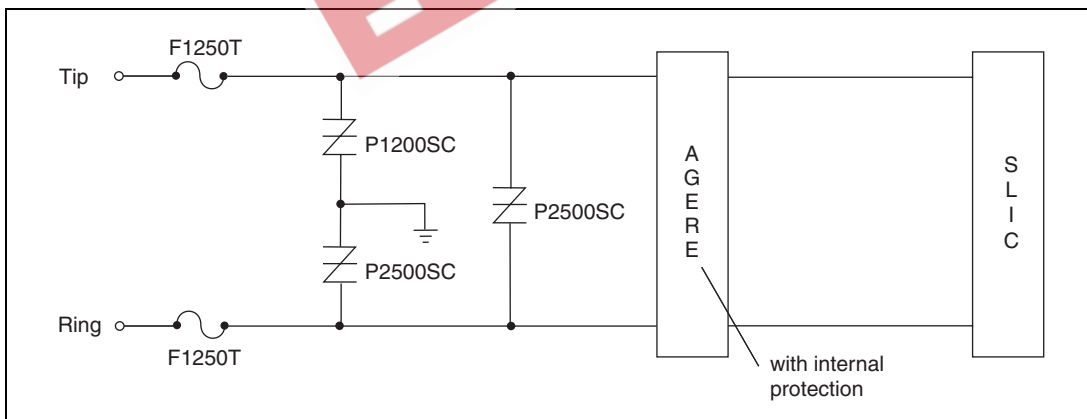

Figure 3.22 SLIC Asymmetrical Protection

Reference Designs

Figure 3.23 illustrates the use of the P2600SA and P0721CA2 for overvoltage protection and the F0500T for overcurrent protection in addition to 20 Ω of series resistance on both Tip and Ring. The series resistance is required to limit the transient surge currents to within the surge current rating of the "A" series SIDACTor devices and the F0500T TeleLink fuse.

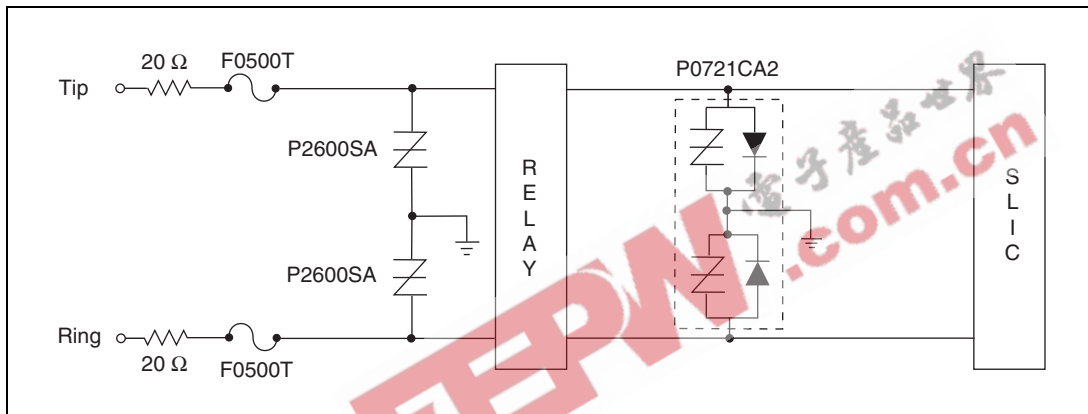

Figure 3.23 SLIC Protection with Fixed Voltage SIDACTor Devices

The illustration of SLIC protection in Figure 3.24 shows Teccor's *Battrax* device protecting Legerity's (formerly AMD's) Am79R79 from overvoltages and uses a F1250T to protect against sustained power cross conditions. The *Battrax* product was designed specifically to protect SLICs that cannot withstand potential differences greater than $V_{REF} \pm 10$ V.

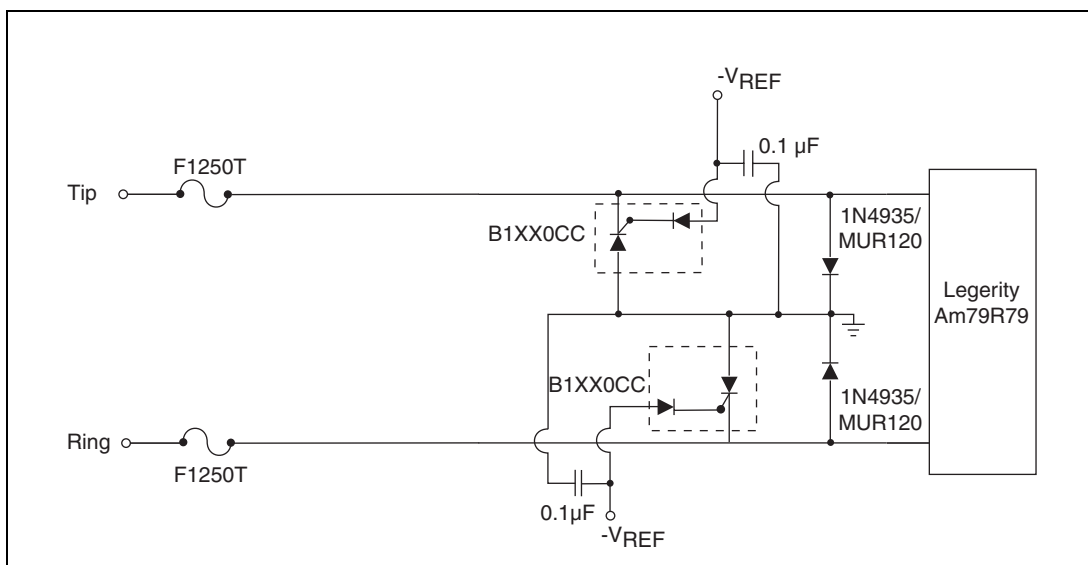

Figure 3.24 SLIC Protection with Programmable Voltage SIDACTor Devices

Figure 3.25 shows protection of a SLIC using $20\ \Omega$ series resistors on both Tip and Ring in addition to Teccor's *Battrax* (B1100CC) and a diode bridge (General Semiconductor part number EDF1BS). However, the overshoot caused by the diode bridge must be considered. The series resistance (a minimum of $20\ \Omega$ on Tip and $20\ \Omega$ on Ring) limits the simultaneous surge currents of 100 A from Tip to Ground and 100 A from Ring to Ground (200 A total) to within the surge current rating of the SA-rated *SIDACtor* device and *Battrax*. The diode bridge shunts all positive voltages to Ground, and the B1100CC shunts all negative voltages greater than $|-V_{REF} - 1.2\text{ V}|$ to Ground.

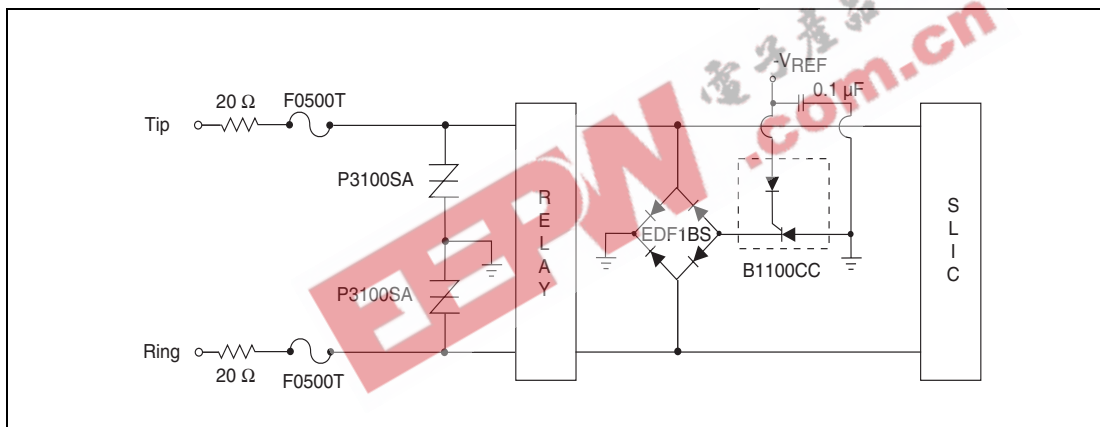

Figure 3.25 SLIC Protection with a Single *Battrax* Device

In Figure 3.26 an application that requires 50 Ω Line Feed Resistors (LFR) uses one B1160CC and two EDF1BS diode bridges in place of multiple SLIC protectors. The overshoot caused by the diode bridge must be considered; however, with this approach it is imperative that the sum of the loop currents does not exceed the *Battrax*'s holding current. In the application shown in Figure 3.26, each loop current would have to be limited to 80 mA. For applications requiring the protection of four twisted pair with one *Battrax*, use the B1200CC and limit each individual loop current to 50 mA.

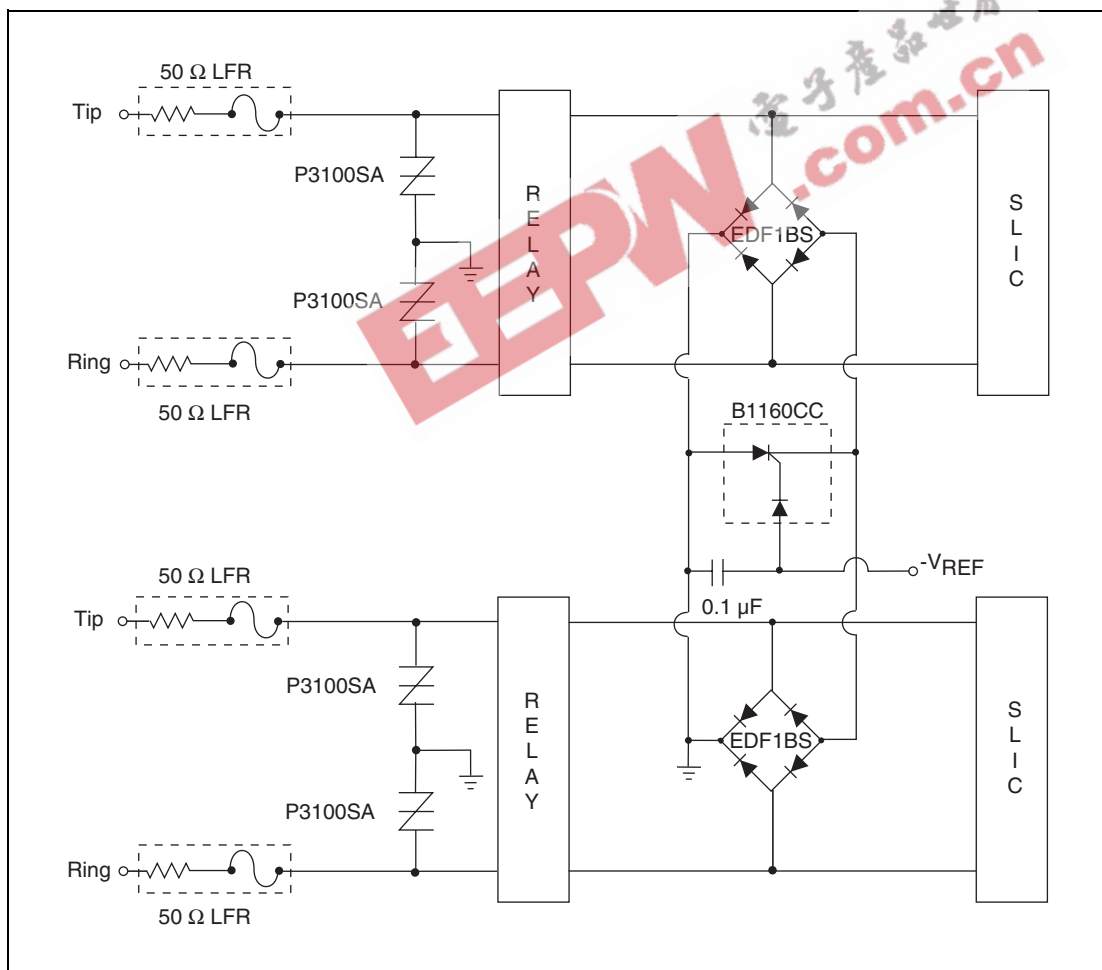

Figure 3.26 SLIC Protection with a Single *Battrax* Device

Figure 3.27 and Figure 3.28 show circuits that use negative *Battrax* devices containing an internal diode for positive surge protection. This obviates using the discrete diodes shown in Figure 3.24.

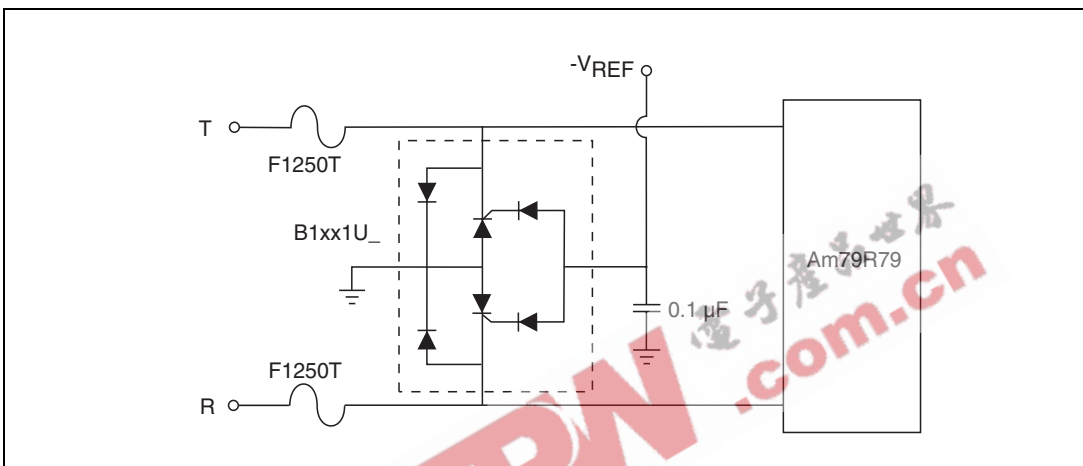

Figure 3.27 SLIC Protection with a Dual *Batrax* Device

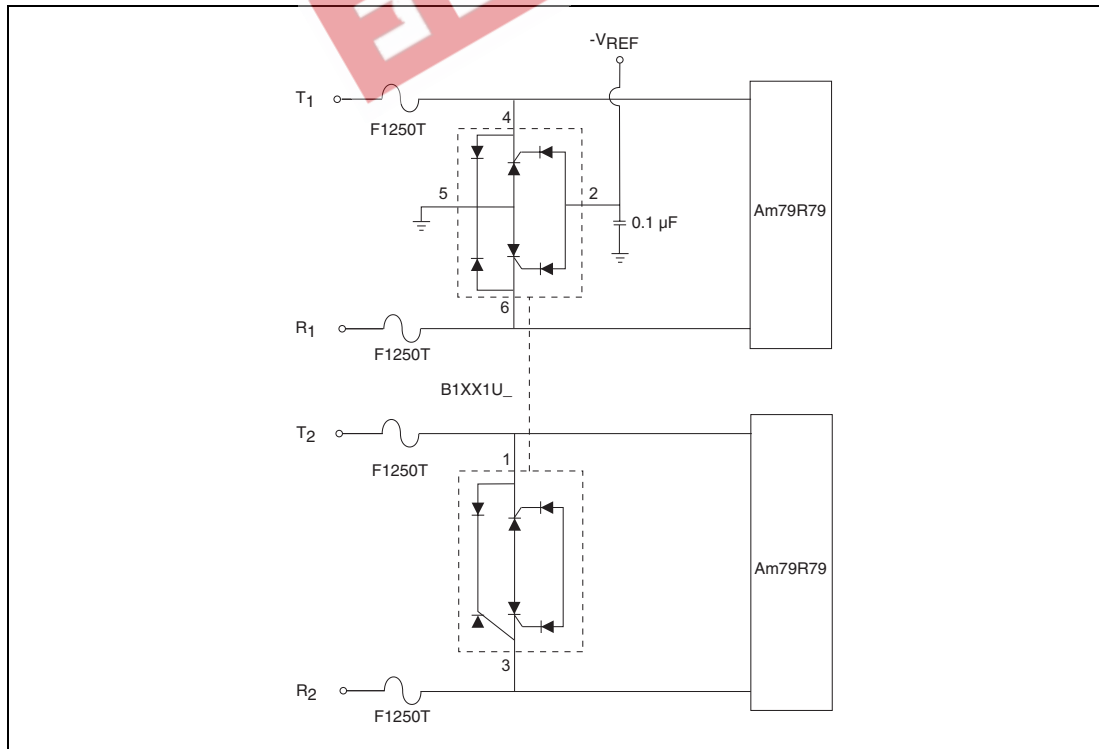

Figure 3.28 SLIC Protection with a Single *Batrax* Quad Negative Device

Reference Designs

Figure 3.29 shows two negative *Battrax* discrete parts and two positive *Battrax* discrete parts. This arrangement is required for SLIC applications using both the positive and negative ringing signals. Figure 3.30 shows a similar application but with the two negative *Battrax* discrete parts and two positive *Battrax* discrete parts integrated into a single surface mount package.

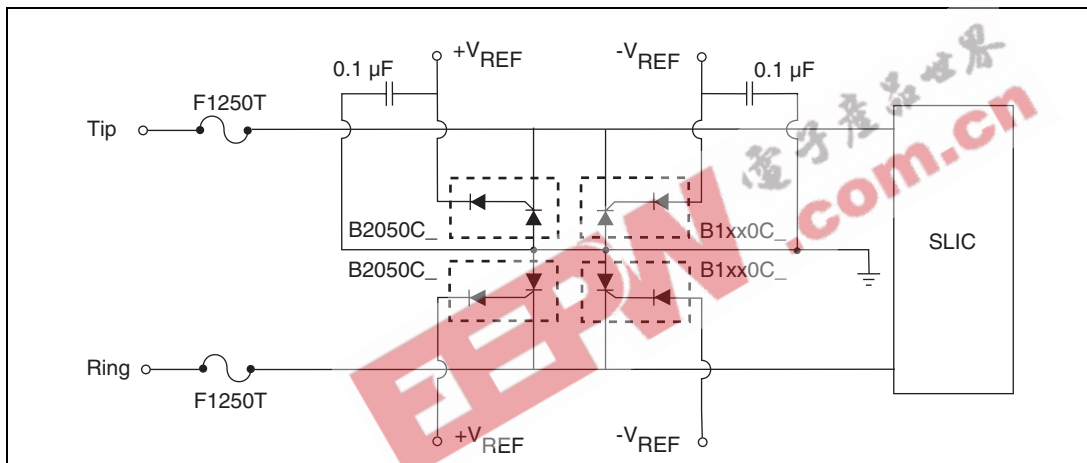

Figure 3.29 SLIC Protection with discrete positive and negative *Battrax* Devices

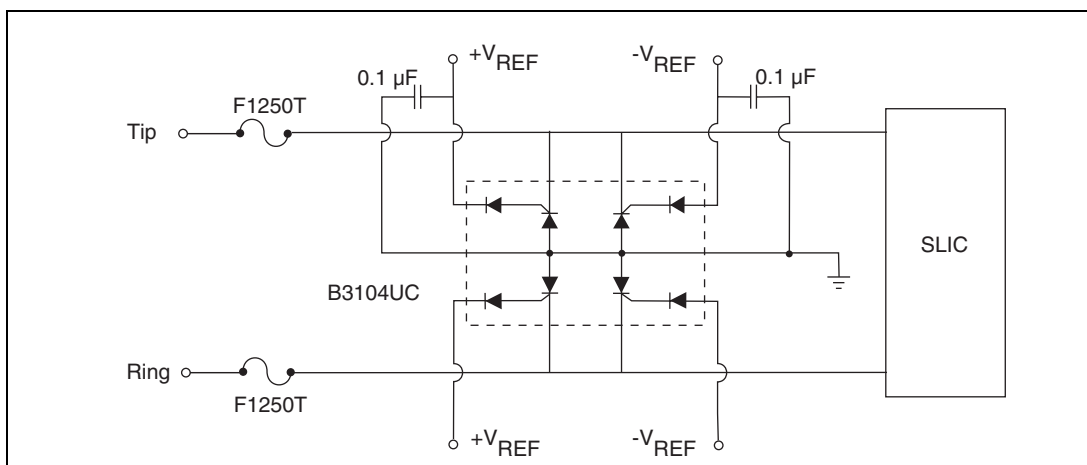

Figure 3.30 SLIC Protection with a *Battrax* Dual Positive/Negative device

PBX Systems

Branch Exchange Switches

PBXs, KSUs, and PABXs contain line cards that support various transmission protocols such as ISDN, T1/E1, HDSL, and ADSL (Figure 3.31). PBXs also have features such as a POTS (plain old telephone service) pull-through which allows stations to have outside line access in the event of power failure. All incoming lines to the PBX are subject to environmental hazards such as lightning and power cross.

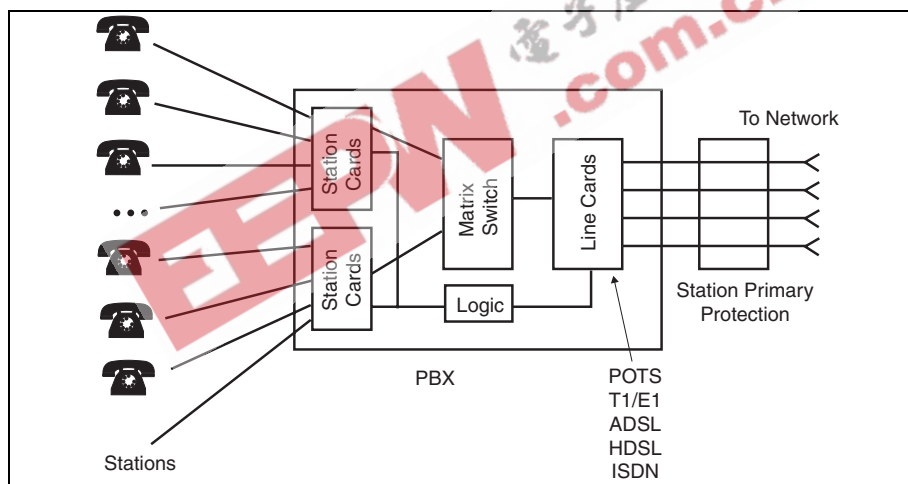

Figure 3.31 PBX Overview

Protection Requirements

Branch exchange switches should be protected against overvoltages that can exceed 800 V and surge currents up to 100 A.

The following regulatory requirements apply:

- TIA-968 (formerly known as FCC Part 68)
- UL 60950

Branch Exchange Reference Circuit

See the following sections of this data book for interface circuits used to protect of PBX line cards:

- For POTS protection, see "Customer Premises Equipment (CPE)" on page 3-3.
- For ADSL protection, see "ADSL Circuit Protection" on page 3-7.
- For HDSL protection, see "HDSL Circuit Protection" on page 3-8.
- For ISDN protection, see "ISDN Circuit Protection" on page 3-10.
- For T1/E1 protection, see "T1/E1 Circuit Protection" on page 3-14.
- For Station Protection, see "Analog Line Cards" on page 3-17.

CATV Equipment

As cable providers enter the local exchange market, protection of CATV (Community Antenna TV) equipment becomes even more critical in order to ensure reliable operation of equipment and uninterrupted service.

Protection Requirements

CATV line equipment should be able to withstand overvoltages that exceed 6000 V and surge currents up to 5000 A. CATV station protectors should be able to withstand overvoltages that exceed 5000 V and surge currents up to 1000 A. The *SIDACtor* devices illustrated in Figure 3.32 through Figure 3.35 meet these requirements.

The following regulatory requirements may apply:

- UL 497C
- SCTE IPS-SP-204
- SCTE Practices
- NEC Article 830

Power Inserter and Line Amplifier Reference Circuit

Figure 3.32 and Figure 3.33 show how the P1900ME *SIDACtor* device is used to protect line amplifiers and power supplies versus using two SCRs and one *SIDACtor* device (Figure 3.34). The P1900ME is used because the peak off-state voltage (V_{DRM}) is well above the peak voltage of the CATV power supply ($90 V_{RMS} \sqrt{2}$), and the peak pulse current rating (I_{PP}) is 3000 A.

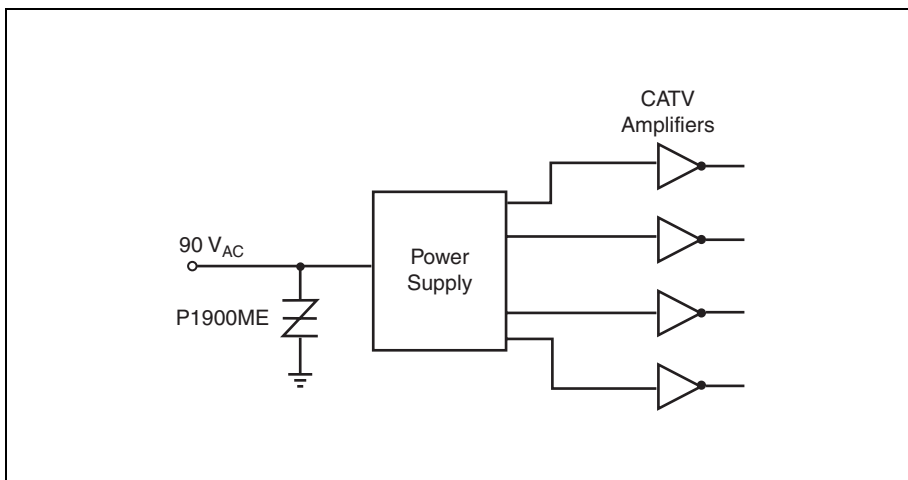

Figure 3.32 CATV Amplifier Diagram

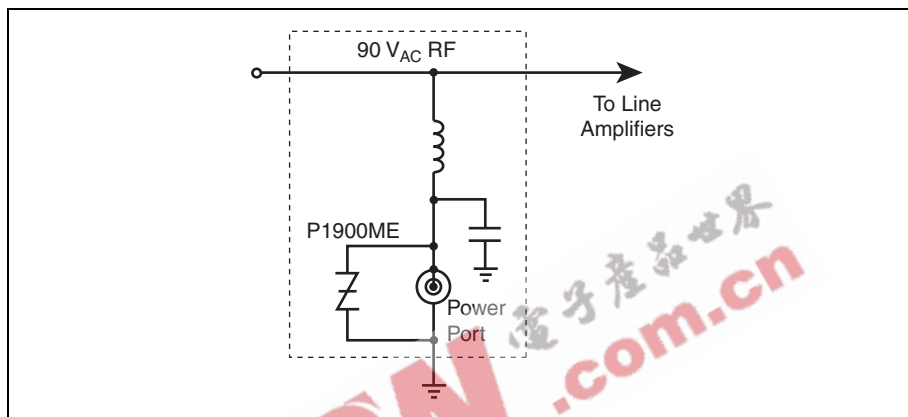

Figure 3.33 CATV Amplifier Protection (incorporated into a power inserter module)

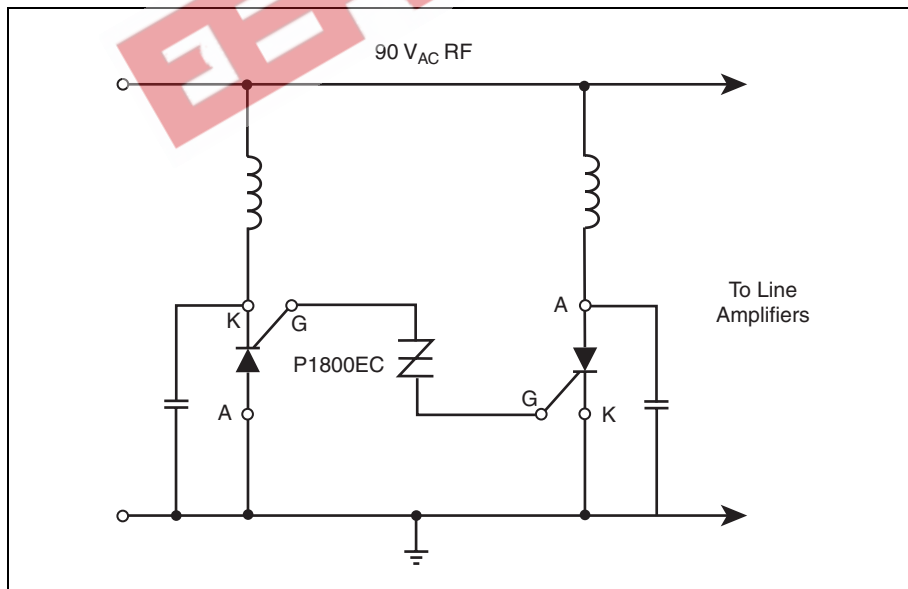

Figure 3.34 CATV Amplifier Protection

Station Protection Reference Circuit

Figure 3.35 shows a P1400AD *SIDACtor* device used in a CATV station protection application. Note that a compensation inductor may be required to meet insertion and reflection loss requirements for CATV networks. If so, the inductor should be designed to saturate quickly and withstand surges up to 200 V and 1000 A. An inductor with a core permeability of approximately 900 Wb/A·m and wound with 24-gauge wire to an inductance

of 20 μH to 30 μH is an example of a suitable starting point, but the actual value depends on the design and must be verified through laboratory testing.

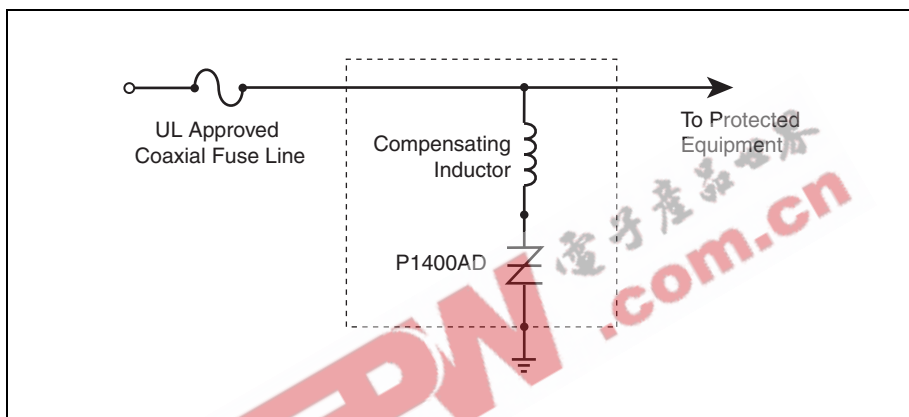

Figure 3.35 CATV Station Protection

Primary Protection

Primary telecommunications protectors must be deployed at points where exposed twisted pairs enter an office building or residence. This requirement is mandated in North America by the National Electric Code (NEC) to protect end users from the hazards associated with lightning and power cross conditions.

Primary protection is provided by the local exchange carrier and can be segregated into three distinct categories:

- Station protection — typically associated with a single twisted pair
- Building entrance protection — typically associated with multiple (25 or more) twisted pair
- Central office protection — typically associated with numerous twisted pair feeding into a switch

Station protectors provide primary protection for a single-dwelling residence or office. The station protector is located at the Network Interface Unit (NIU), which acts as the point of demarcation, separating the operating company's lines from the customer's.

Building entrance protection is accomplished by installing a multi-line distribution panel with integrated overvoltage protection. These panels are normally located where multiple twisted pairs enter a building.

A five-pin protection module plugged into a Main Distribution Frame (MDF) provides Central and Remote Office protection. Like station and building entrance protection, the MDF is located where exposed cables enter the switching office.

Teccor also offers a full line of five-pin protectors. For further details, contact factory at protectionsystems@teccor.com or +1 972-580-7777.

Protection Requirements

Station protectors must be able to withstand 300 A 10x1000 surge events. The building entrance protectors and CO protectors must be able to withstand 100 A 10x1000 surge events. Figure 3.36 shows building entrance protector and CO protector asymmetrical solutions. Figure 3.37 shows building entrance protector and CO protector balanced solutions.

The following regulatory requirements apply:

- UL 497
- GR 974-CORE
- ITU K.28

Primary Protection Reference Circuit

Figure 3.36 and Figure 3.37 show different configurations used in primary protection. Note that the peak off-state voltage (V_{DRM}) of any device intended for use in primary protection applications should be greater than the potential of a Type B ringer superimposed on a POTS (plain old telephone service) battery.

$$150 V_{RMS} \sqrt{2} + 56.6 V_{PK} = 268.8 V_{PK}$$

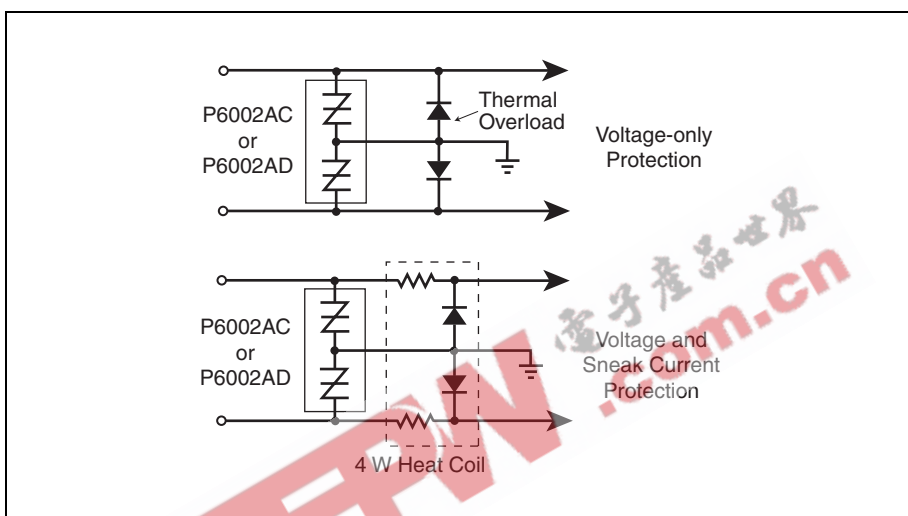

Figure 3.36 Primary Protection

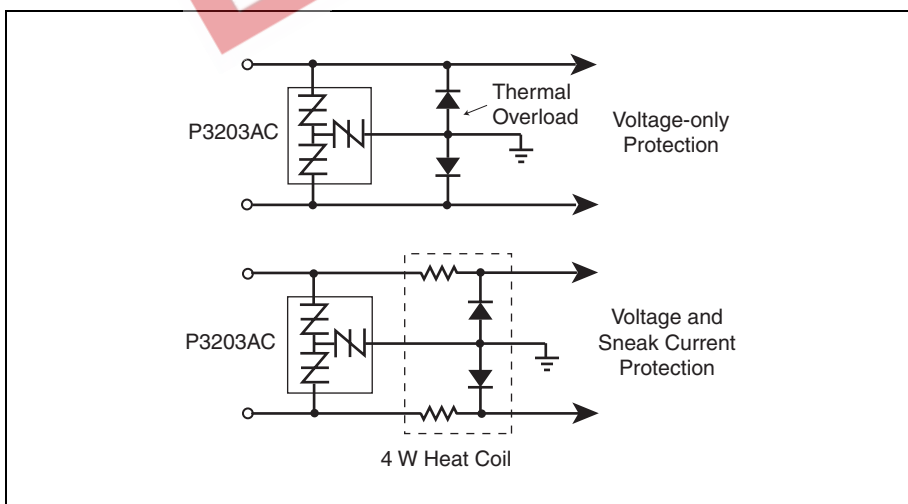

Figure 3.37 Balanced Primary Protection

Secondary Protection

Secondary protectors (stand alone units or integrated into strip protectors and UPSs) are adjunct devices used to enhance the protection level of customer premise equipment (CPE). Due to the inadequate level of protection designed into CPE, secondary protectors often are required to prevent premature failure of equipment exposed to environmental hazards (Figure 3.38).

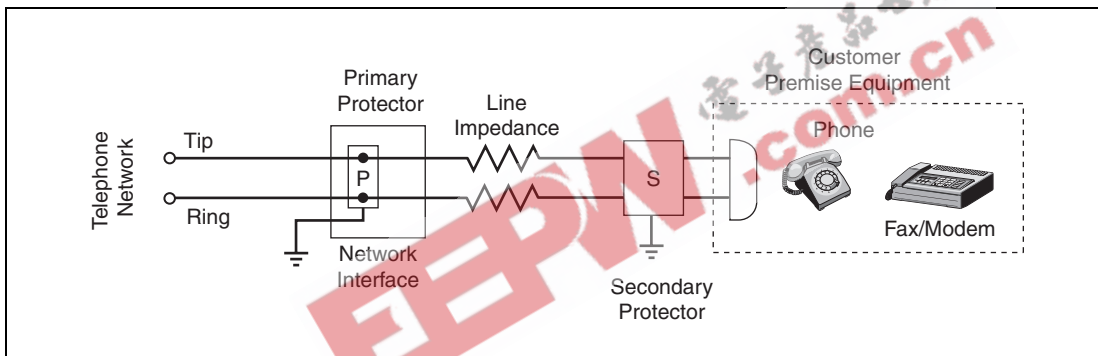

Figure 3.38 CPE Secondary Protection

Protection Requirements

Secondary protectors should be able to withstand overvoltages that can exceed 800 V and surge currents up to 100 A. Figure 3.39 illustrates a *SIDACTor* device selected because the associated peak pulse current (I_{PP}) is sufficient to withstand the lightning immunity tests of TIA-968 (formerly known as FCC Part 68) without the additional use of series line impedance. Likewise, Figure 3.39 illustrates a fuse selected because the amps²time (I^2t) rating is sufficient to withstand the lightning immunity tests of TIA-968, but low enough to pass UL power cross conditions.

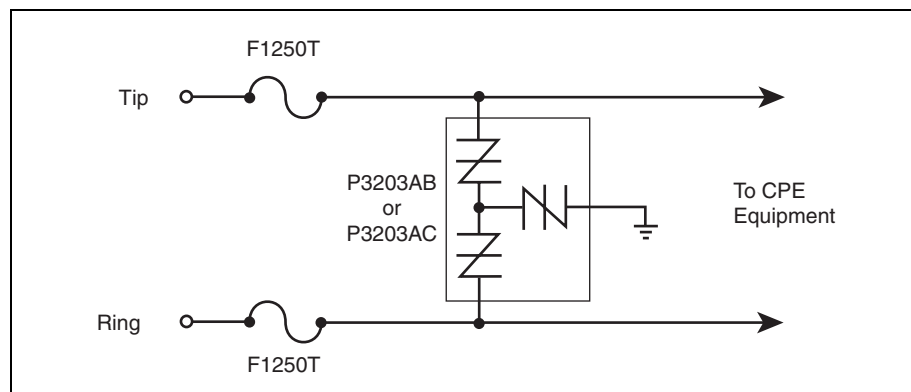

Figure 3.39 CPE Protection

Secondary Protection Reference Circuit

Figure 3.38 also shows an example of an interface design for a secondary protector. The P3203AB *SIDACtor* device is used because the peak off-state voltage (V_{DRM}) is greater than the potential of a Type B ringer signal superimposed on the POTS (plain old telephone service) battery.

$$150 V_{RMS} \sqrt{2} + 56.6 V_{PK} = 268.8 V_{PK}$$

Coordination between the station protector and the secondary protector occurs due to the line impedance between the two devices. The line impedance helps ensure that the primary protector will begin to conduct while the secondary protector limits any of the let-through voltage to within the V_S rating of the *SIDACtor* device.

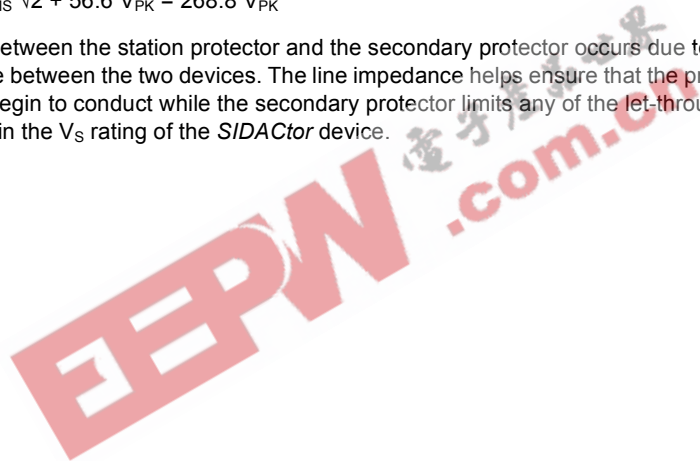

Triac Protection

Thyristors

Damage can occur to a thyristor if the thyristor's repetitive peak off-state voltage is exceeded. A thyristor's repetitive peak off-state voltage may be exceeded due to dirty AC power mains, inductive spikes, motor latch up, and so on.

Thyristor Reference Circuit

Figure 3.40 and Figure 3.41 show two different methods of protecting a triac. In Figure 3.40, a *SIDACtor* device is connected from MT2 to the gate of the triac. When the voltage applied to the triac exceeds the *SIDACtor* device's V_{DRM} , the *SIDACtor* device turns on, producing a gate current which turns the triac on.

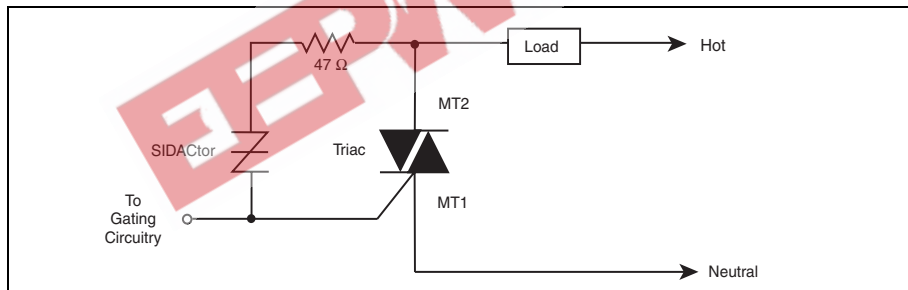

Figure 3.40 TRIAC Protection

The circuit in Figure 3.41 places a *SIDACtor* device across MT2 and MT1 of the triac. In this instance the *SIDACtor* device protects the triac by turning on and shunting the transient before it exceeds the V_{DRM} rating of the triac.

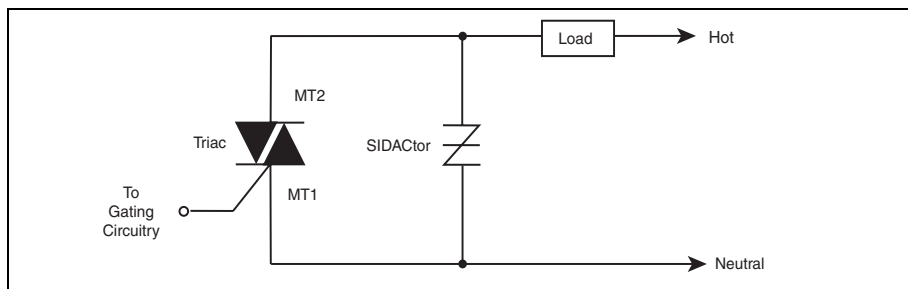

Figure 3.41 TRIAC Protection

With both methods, consider the following designs when using a *SIDACtor* device to protect a thyristor:

- V_{DRM} of the *SIDACtor* device $<$ V_{DRM} of Triac
- *SIDACtor* device $V_{DRM} > 120\%$ $V_{PK}(\text{power supply})$
- *SIDACtor* device must be placed behind the load

Data Line Protectors

In many office and industrial locations, data lines (such as RS-232 and ethernet) and AC power lines run in close proximity to each other, which often results in voltage spikes being induced onto the data line, causing damage to sensitive equipment.

Protection Requirements

Data lines should be protected against overvoltages that can exceed 1500 V and surge currents up to 50 A.

Data Line Reference Circuit

Figure 3.42 shows how a *SIDACTor* device is used to protect low voltage data line circuits.

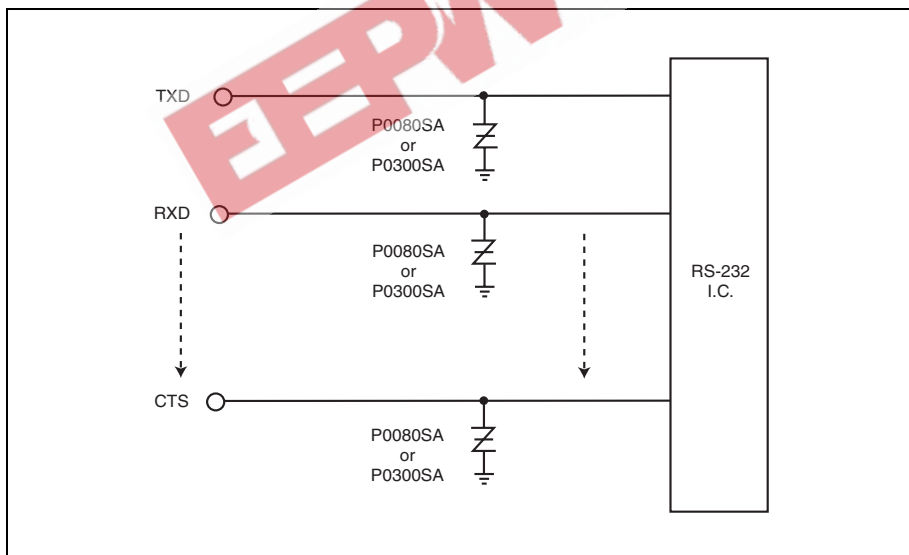

Figure 3.42 Data Line Protection

LAN / WAN Protectors

10Base-T Protection

Capacitance across the pair of wires = $(D1 \parallel D2) + P0640EA/SA$

The MUR 1100E diodes capacitance is approximately $(10 \text{ pF} \parallel 10 \text{ pF})$ 20 pF. Then, adding the capacitive effect of the *SIDACtor* (typically 50 pF), the total capacitance across the pair of wires is approximately 14 pF. This provides a GR 1089 intra-building compliant design. (Figure 3.43)

Note: MURS160T3 is an SMT equivalent of the MUR 1100E.

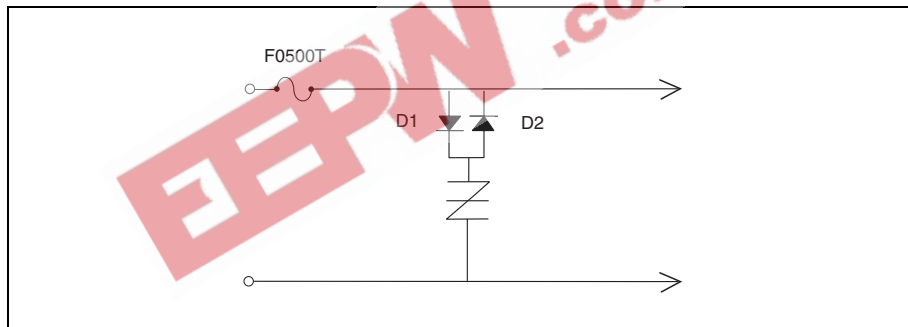

Figure 3.43 10Base-T Metallic-only Protection

Figure 3.44 shows an application requiring longitudinal protection.

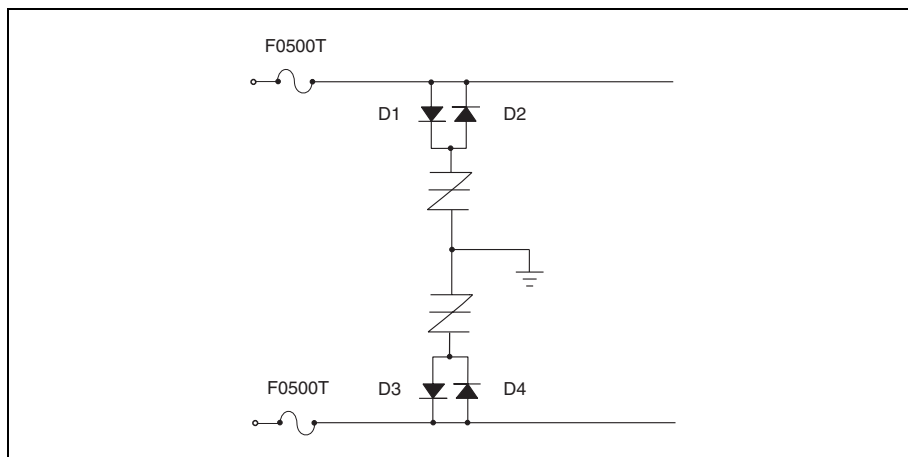

Figure 3.44 10Base-T Metallic and Longitudinal Protection

100Base-T Protection

Capacitance across the pair of wires = (D1 || D2) + P0640EA/SA + (D3 || D4)

The MUR 1100E pair of diodes capacitance is approximately (10 pF || 10 pF) 20 pF. Then, adding the capacitive effect of the P0640EA/SA (typically 50pF), the total capacitance across the pair of wires is approximately 8 pF. This will provide a GR 1089 intra-building compliant design. (Figure 3.45)

Note: MURS160T3 is a SMT equivalent of the MUR 1100E.

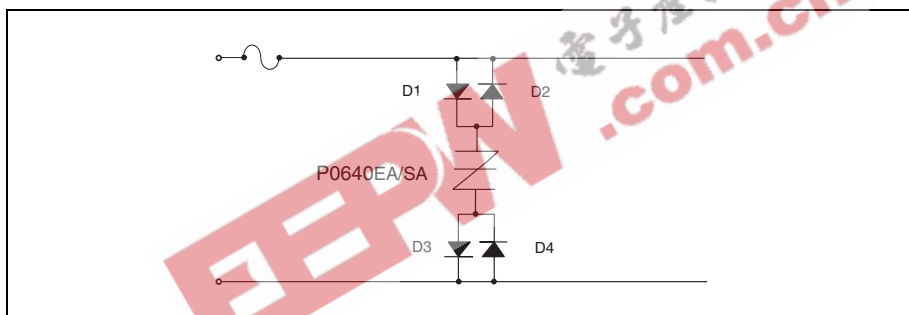

Figure 3.45 100 Base-T Protection

The P0642SA is a very low capacitance device that requires no compensating diodes. (Figure 3.46)

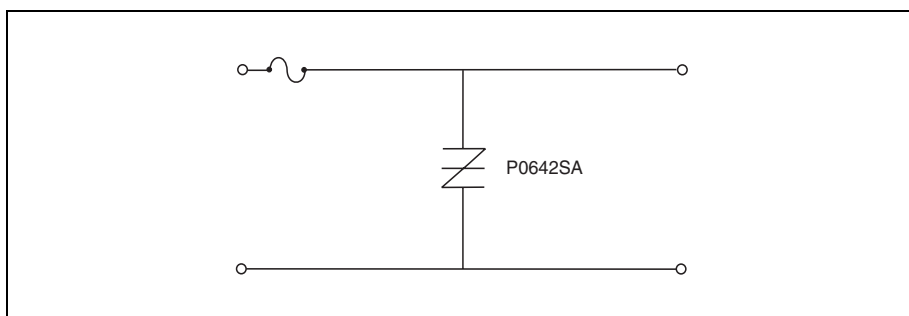

Figure 3.46 100 Base-T Protection Without External Compensation

4

Regulatory Requirements

Due to the enormous cost of interrupted service and failed network equipment, telephony service providers have adopted various specifications to help regulate the reliability and performance of the telecommunications products that they purchase. In Europe and much of the Far East, the most common standards are ITU-T K.20 and K.21. In North America, most operating companies base their requirements on GR 1089, TIA-968 (formerly known as FCC Part 68), and UL 60950.

Note: This section is a paraphrase of existing documents and does not cover the listed regulatory requirements in their entirety. This information is intended to be used only as a reference. For exact specifications, obtain the referenced document from the appropriate source.

GR 1089–Core	4-3
ITU-T K.20 and K.21	4-10
TIA/EIA-IS-968 (formerly known as FCC Part 68)	4-14
UL 60950 3rd Edition (formerly UL 1950, 3rd edition)	4-16
UL 497	4-24
UL 497A	4-27
UL 497B	4-30
UL 497C	4-32
Regulatory Compliant Solutions	4-34
Surge Waveforms for Various Standards	4-37

EEPW 电子产品世界
 .com.cn

GR 1089–Core

In the United States, the telecommunication network is primarily operated by the Regional Bell Operating Companies (RBOC) who follow the standards set by GR 1089 or a derivative thereof. GR 1089–Core (often referred to as GR 1089), “Electromagnetic Compatibility and Electrical Safety Generic Criteria for Network Telecommunications Equipment,” covers the requirements for telecommunications equipment connected to the outside world through twisted pair. It also addresses the criteria for protection from lightning and AC power cross disturbances.

Because twisted pair are metallic conductors exposed to lightning and AC power faults, GR 1089 documents the requirements to be met by manufacturers of public switched telephone network (PSTN) equipment to ensure safe and reliable operation.

The criteria for these standards are based on transient conditions at exposed sites, such as remote facilities, central offices, and customers' premises where operating companies provide some type of primary voltage protection to limit transient voltages to 1000 V peak for surge conditions and 600 V rms for power cross conditions.

All network equipment shall be listed by a Nationally Recognized Testing Laboratory (NRTL) if the equipment is directly powered by Commercial AC. Network equipment located on customer premises shall be listed by NRTL.

In conjunction with primary voltage protectors, operating companies also may incorporate fuse links if there is the possibility of exposing the twisted pair to outside power lines. These fuse links are equivalent to 24- or 26-gauge copper wire and are coordinated with the current-carrying capacity of the voltage protector.

The last element of protection that may be provided by the operating company are current limiters which, if provided, are found on the line side of the network equipment after the primary voltage protection device. These current limiters typically come in the form of heat coils and have a continuous rating of 350 mA.

Requirements

Equipment required to meet GR 1089 must be designed to pass:

- Both First and Second Level Lightning Surge and AC Power Fault Tests
- Current Limiter Test
- Short Circuit Test

A minimum of three units are tested for each of the operating states in which the Equipment Under Test (EUT) may be expected to function — idle, transmit, receive, on-hook, off-hook, talking, dialing, ringing, and testing. Table 4.1 and Table 4.2 show test connections, and Figure 4.1 shows the connection appearances.

Table 4.1 Test Conditions

Test	Two-wire Interface	Four-wire Interface
A	1. Tip to Generator, Ring to Ground 2. Ring to Generator, Tip to Ground 3. Tip and Ring to Generator simultaneously	1. Each lead (T, R, T ₁ , R ₁) to the Generator with the other three leads grounded 2. Tip and Ring to Generator, simultaneously; T ₁ and R ₁ to Ground 3. T ₁ and R ₁ to Generator, simultaneously; Tip and Ring to Ground
B	Tip and Ring to Generator simultaneously	T, R, T ₁ , R ₁ to Generator simultaneously

Notes:

- When performing longitudinal tests, the test generator will have a dual output.
- Refer to Table 4.2 for switch positions for each test condition.

Table 4.2 Connections to Test Generator

Condition	S1	S2	S3	S4
Condition A-1 of Table 4.1	Closed	Open	Open	Closed
Condition A-2 of Table 4.1	Open	Closed	Closed	Open
Condition A-3 of Table 4.1	Closed	Open	Closed	Open

Note: Other outside plant leads associated with the unit should be grounded during the test and the test repeated with these leads terminated as in service. Leads that do not connect to outside plant should be terminated as appropriate for the operating mode(s) of the unit.

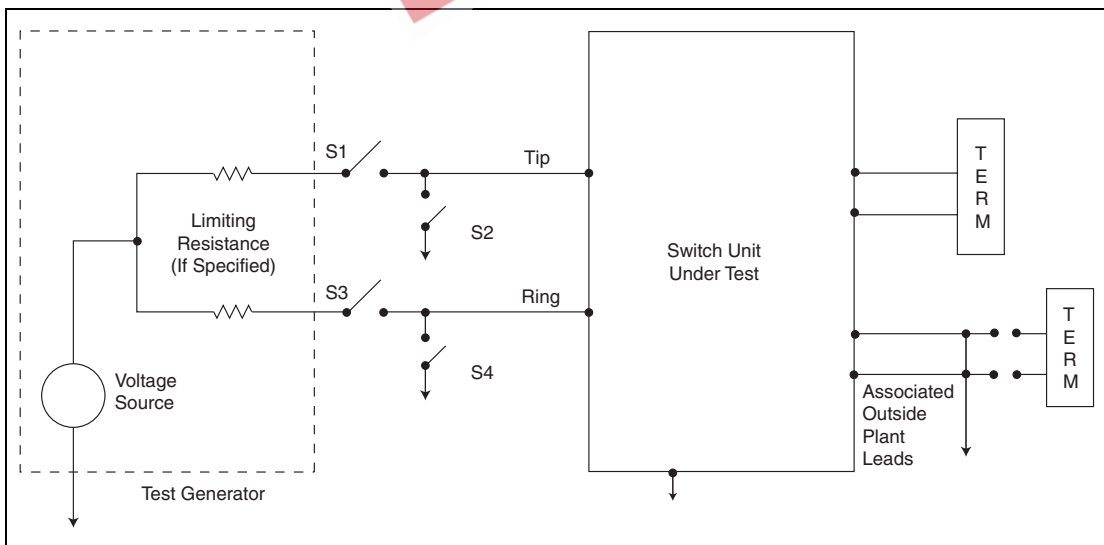

Figure 4.1 Connection Appearances

Passing Criteria

Passing criteria for the First Level Lightning Surge Test and the First Level AC Power Fault Test is that the EUT will not be damaged and that it will operate as intended after the stress is removed. Passing criteria for the Second Level Lightning Surge Test and Second Level

AC Power Fault Test is that the EUT may be damaged, but it may not become a fire, fragmentation, or electrical safety hazard. Passing criteria for the Current Limiter Test is that the EUT may be damaged but it may not exceed the acceptable time/current criteria (that is, cannot cause the wiring simulator as shown in Figure 4.2 to open) nor become a fire, fragmentation, or electrical safety hazard.

The indicator used in measuring fire, fragmentation, and electrical safety hazards is a bleached, untreated cotton cheesecloth wrapped around the EUT. Compliance with testing is determined by the absence of ignition, charring, and the ejection of molten material or fragments.

First Level Lightning Surge Test

To pass the First Level Lightning Surge Test, the EUT must be undamaged and continue to operate properly after the stress is applied. This is referred to as passing “operationally.” Table 4.3 presents the conditions for the First Level inter-building criteria. Applicants have the option to submit their equipment to meet surges 1, 2, 4, and 5 or surges 3, 4, and 5. Table 4.4 presents the conditions for the intra-building criteria.

Table 4.3 First Level Lightning Surge Test

Test (Notes 1 & 2)	Surge Voltage (V _{PK})	Waveform (μs)	Surge Current per Conductor (A)	Repetitions Each Polarity	Test Connections (Table 4.1, Figure 4.1)
1	±600	10x1000	100	25	A
2 (Note 3)	±1000	10x360	100	25	A
3 (Note 3)	±1000	10x1000	100	25	A
4 (Note 4)	±2500	2x10	500	10	B
5 (Note 5)	±1000	10x360	25	5	B

Notes:

1. Primary protectors are removed for all tests.
2. For EUT containing secondary voltage limiting and current limiting protectors, tests are to be performed at the indicated voltage(s) and repeated at a reduced voltage and current just below the operating threshold of the secondary protectors.
3. Test 1 and 2 can be replaced with Test 3 or vice versa.
4. Alternatively, a surge generator of 1.2x50 μs open-circuit voltage waveform (8x20 μs short-circuit current waveform) per IEEE C62.41 may be used. The current shall be limited by the inclusion of a series 3 Ω resistor placed externally to the surge generator.
5. This test is to be performed on up to 12 Tip and Ring pairs simultaneously.

Table 4.4 Intra-Building Lightning Surge Test

Test	Surge Voltage (V _{PK})	Wave-form (μs)	Surge Current per Conductor (A)	Repetitions Each Polarity	Test Connections (Table 4.1, Figure 4.1)
1	±800	2x10	100	1	A1, A2
2	±1500	2x10	100	1	B

Notes:

- For EUT containing secondary voltage limiting and current limiting protectors, tests are to be performed at the indicated voltage(s) and repeated at a reduced voltage and current just below the operating threshold of the secondary protectors.
- Alternatively, a surge generator of 1.2x50 μs open-circuit voltage waveform (8x20 μs short-circuit current waveform) per IEEE C62.41 may be used. The current shall be limited by the inclusion of a series 6 Ω resistor for Test 1 and a 12 Ω resistor for Test 2, placed externally to the surge generator.

Second Level Lightning Surge Test

The Second Level Lightning Surge Test, presented in Table 4.5, does not require the EUT to pass operationally, but GR 1089 does require that the EUT not become a fire, fragmentation, or electrical safety hazard. This is referred to as passing “non-operationally.”

Table 4.5 Second Level Lightning Surge Test

Test	Surge Voltage (V _{PK})	Waveform (μs)	Surge Current (A)	Repetitions Each Polarity	Test Connections (Table 4.1, Figure 4.1)
1	±5000	2x10	500	1	B

Notes:

- Primary protectors are removed.
- For EUT containing secondary voltage limiting and current limiting protectors, tests are to be performed at the indicated voltage(s) and repeated at a reduced voltage and current just below the operating threshold of the secondary protectors.
- Alternatively, a surge generator of 1.2x50 μs open-circuit voltage waveform (8x20 μs short-circuit current waveform) per IEEE C62.41 may be used. The current shall be limited by the inclusion of a series 8 Ω resistor placed externally to the surge generator.

AC Power Fault Tests

Power companies and telephone operating companies often share telephone poles and trenches; therefore, network equipment is often subjected to the voltages seen on power lines. If direct contact between the telephone line and the primary power line occurs, the operating company’s network equipment may see as much as 600 V rms for five seconds, by which time the power company’s power system should clear itself. If direct contact occurs with the secondary power line, voltages will be limited to 277 V rms; however, these voltages may be seen indefinitely because the resultant current may be within the operating range of the power system, and the power system will not reset itself.

Another risk involved with power lines is indirect contact. Because of the large magnetic fields created by the currents in the power lines, large voltages may be induced upon phone lines via electro-magnetic coupling. In this instance voltages should be limited to 1000 V peak and 600 V rms using primary protectors, while the current will be limited by the current-carrying capacity of the 24-gauge wire.

First Level AC Power Fault Criteria

Table 4.6 presents test conditions for the First Level AC Power Fault Test. The EUT is required to pass operationally.

Table 4.6 First Level AC Power Fault Test

Test	Applied Voltage, 60 Hz (V _{RMS})	Short Circuit Current per Conductor (A)	Duration	Primary Protectors	Test Connections (Table 4.1, Figure 4.1)
1 (Note 1)	50	0.33	15 min	Removed	A
2 (Note 1)	100	0.17	15 min	Removed	A
3 (Note 1)	200, 400, 600	1A at 600 V	60 applications, 1 s each	Removed	A
4 (Note 4)	1000	1	60 applications, 1 s each	In place	B
5 (Note 2)	N/A	N/A	60 applications, 5 s each	Removed	N/A
6 (Note 3)	600	0.5	30 s	Removed	A
7 (Note 3)	600	2.2	2 s	Removed	A
8 (Note 3)	600	3	1 s	Removed	A
9 (Note 3)	1000	5	0.5 s	In place	B

Notes:

- For EUT containing secondary voltage limiting and current limiting protectors, tests are to be performed at the indicated voltage(s) and repeated at a reduced voltage and current just below the operating threshold of the secondary protectors.
- Test 5 simulates a high impedance induction fault. For specific information, please contact Teccor Electronics.
- Test conditions 6 through 9 are objective, not mandatory, requirements.
- Sufficient time may be allowed between applications to preclude thermal accumulation.

Second Level AC Power Fault Criteria

Test conditions for the Second Level AC Power Fault Test are dependent on whether the EUT is intended for customer premises equipment or non-customer premises equipment. In both instances, although the EUT is not required to pass operationally, it may not become a fire, fragmentation, or electrical safety hazard.

Second Level AC Power Fault Criteria for Non-customer Premises Equipment

Table 4.7 presents test conditions for non-customer premises equipment. (Note that test conditions 1, 3, and 4 may be omitted if the EUT has previously met UL 60950.) See Figure 4.1 for test connection appearances.

Table 4.7 Second Level AC Power Fault Test for Non-Customer Premises Equipment

Test (Notes 1, 2)	Applied Voltage, 60 Hz (V _{RMS})	Short Circuit Current per Conductor (A) (Note 5)	Duration	Test Connections (Table 4.1, Figure 4.1)
1	120, 277	25	15 min	A
2	600	60	5 s	A
3	600	7	5 s	A
4 (Note 3)	100-600	2.2A at 600 V	15 min	A
5 (Note 4)	N/A	N/A	15 min	N/A

Notes:

- Primary protectors are removed for all tests.
- For EUT containing secondary voltage limiting and current limiting protectors, tests are to be performed at the indicated voltage(s) and repeated at a reduced voltage and current just below the operating threshold of the secondary protectors.
- This test is to be performed between the ranges of 100 V to 600 V and is intended to produce the greatest heating affect.
- Test 5 simulates a high impedance induction fault. Specific information regarding this test is available upon request.
- These tests are repeated using a short-circuit value just below the operating threshold of the current limiting device, or, if the EUT uses a fuse as current limiting protection, the fuse may be bypassed and the short circuit current available adjusted to 135% of the fuse rating.
- Intra-building, second level lower fault test uses test condition 1 only. The applied voltage is at 120 V rms only.

Second Level AC Power Fault for Customer Premises Equipment

For customer premises equipment, the EUT is tested to the conditions presented in Table 4.8 and connected to a circuit equivalent to that shown in Figure 4.2. During this test, the wiring simulator cannot open. For equipment that uses premises type of wiring, the wiring simulator is a 1.6 A Type MDQ fuse from Bussman. For equipment that is connected by cable, the wiring simulator is a piece of 26-gauge copper wire.

Table 4.8 Second Level AC Power Fault for Customer Premises Equipment

Test	Applied Voltage, 60 Hz (V _{RMS}) (Notes 2, 3)	Source Impedance Ω	Test Connections (Table 4.1, Figure 4.2)
1	300	20	(Note 1)
2	600	20	A

Notes:

- Applied between exposed surfaces and Ground
- The 60 Hz signal is applied with an initial amplitude of 30 V rms and increased by 20% every 15 minutes until one of the following occurs:
 - Voltage reaches the maximum specified
 - Current reaches 20 A or the wiring simulator opens
 - EUT fails open circuit
- If the EUT fails open circuit, the test continues for an additional 15 minutes to ensure that another component of the EUT does not create a fire, fragmentation, or electrical safety hazard.

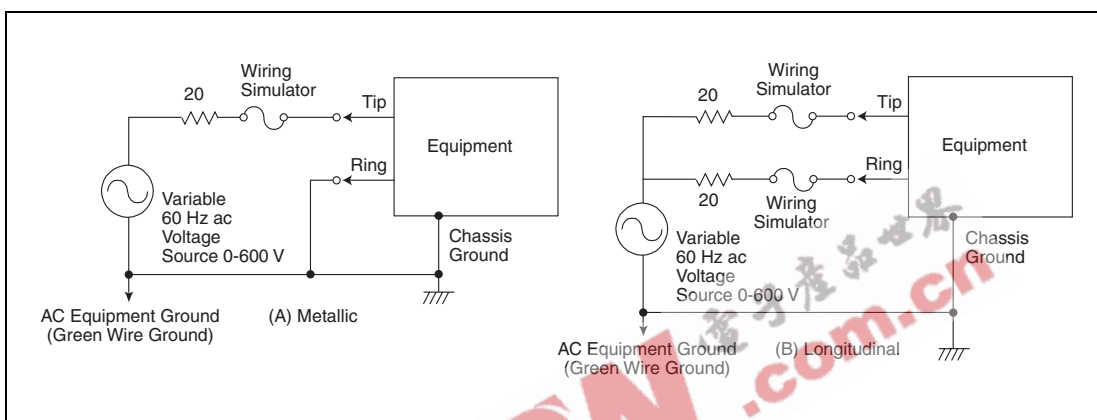

Figure 4.2 Second Level AC Power Fault and Current Limiter Connection

Current Limiting Protector Test

The purpose of the Current Limiting Protector Test, presented in Table 4.9, is to determine if the EUT allows an excessive amount of current flow under power fault conditions. During this test, the EUT is connected to a circuit equivalent to that shown in Figure 4.2 with a 1.6 A Type MDQ fuse from Bussman used as the wiring simulator. If the EUT draws enough current to open the fuse, then the acceptable time/current criteria have not been met, and external current limiting protectors must be specified for use with that equipment in the manufacturer's documentation.

Table 4.9 Current Limiting Protector Test

Test	Applied Voltage, 60 Hz (V _{RMS})	Source Impedance Ω	Duration	Test Connections (Table 4.1, Figure 4.2)
1	600	2	15 min	A

Short-circuit Test

In addition to the AC Power Fault and Current Limiter Tests, equipment must also pass a Short-circuit Test to comply with GR 1089. During this test, a short-circuit condition is applied to the following Tip and Ring appearances for 30 minutes while the EUT is powered and under operating conditions:

- Tip-to-Ring, Tip-to-Ground with Ring open circuit
- Ring-to-Ground with Tip open circuit
- Tip- and Ring-to-Ground simultaneously for 30 minutes

At no time will the short circuit exceed 1 Ω. For equipment with more than one twisted pair, the short circuit is applied to all twisted pair simultaneously. To comply with the short circuit test, the EUT must function normally after the short-circuit condition is removed, and a fire hazard may not be present. The equipment shall not require manual intervention to restore service.

ITU-T K.20 and K.21

Although the International Telecommunication Union (ITU) does not have the authority to legislate that organizations follow their recommendations, their standards are recognized throughout Europe and the Far East.

ITU-T, the Telecommunication Standardization Sector of the ITU, developed fundamental testing methods that cover various environmental conditions to help predict the survivability of network and customer-based switching equipment. The testing methods cover the following conditions:

- Surges due to lightning strikes on or near twisted pair and plant equipment (excluding a direct strike)
- Short-term induction of AC voltage from adjacent power lines or railway systems
- Direct contact between telecommunication lines and power lines (often referred to as AC power cross)

Two ITU-T standards apply for most telecommunications equipment connected to the network:

- ITU-T K.20
- ITU-T K.21

ITU-T K.20 is primarily for switching equipment powered by the central office; however, for complex subscriber equipment, test administrators may choose either K.20 or K.21, depending on which is deemed most appropriate.

Note: Both standards are intended to address equipment reliability versus equipment safety. For specific concerns regarding equipment safety, research and follow national standards for each country in which the equipment is intended for use.

K.21 covers telecommunication equipment installed in customer premises. Equipment submitted under these requirements must meet one of two levels: basic or enhanced. Guidelines for determining under which level the equipment under test (EUT) falls can be found in ITU-T K.11, but note that the final authority rests with the test administrator. ITU-T K.44 describes the test conditions used in K.20 and K.21.

ITU-T defines the following acceptance criteria:

- **Criterion A** states that equipment shall withstand the test without damage and shall operate properly after the test. It is not required to operate correctly during the test.
- **Criterion B** states that a fire hazard shall not occur as a result of the tests. Any damage shall be confined to a small part of the equipment.

Table 4.10 shows the lightning surge test conditions for ITU K.20. Figure 4.3 shows the connection schematic for the lightning surge tests. Table 4.11 shows the power cross test conditions for ITU K.20. Figure 4.4 shows the connection schematic for the power cross tests. Table 4.12 and Table 4.13 show the same test conditions respectively for ITU K.21.

Table 4.10 K.20 Lightning Test Conditions for Telecom Equipment in Central Office/Remote Terminal

Voltage (10x700 μs)		Current (5x310 μs) Basic/Enhanced (A)	Repetitions *	Primary Protection	Acceptance Criteria
Single Port Metallic and Longitudinal Basic/Enhanced	Multiple Ports Longitudinal Only Basic/Enhanced				
1 kV/1.5 kV		25/37.5	±5	None **	A
4 kV/4 kV		100/100	±5	Installed if used	A
	1.5 kV/1.5 kV	37.5/37.5	±5	None	A
	4 kV/6 kV	100/150	±5	Installed if used	A

* One-minute rest between repetitions

** This test is not conducted if primary protection is used.

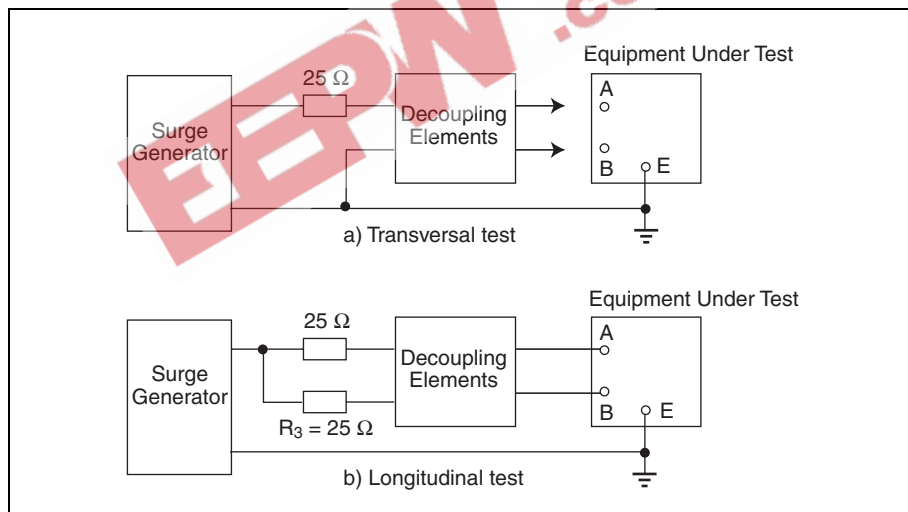

Figure 4.3 Connection Appearances

Regulatory Requirements

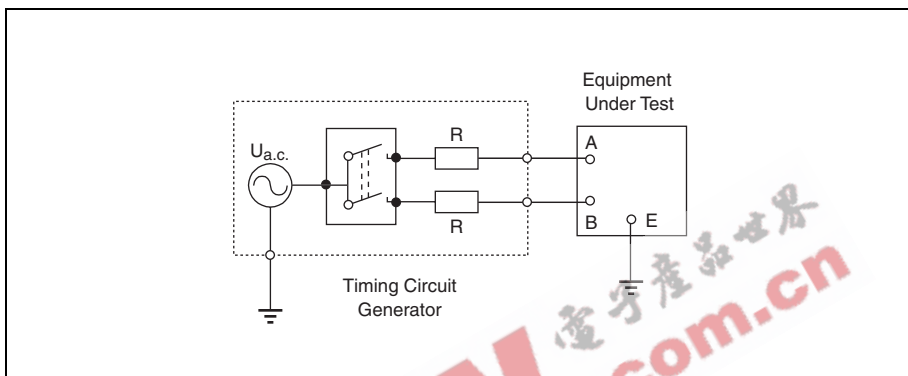

Figure 4.4 Connection Appearances ($R = 10 \Omega, 20 \Omega, 40 \Omega, 80 \Omega, 160 \Omega, 300 \Omega, 600 \Omega,$ and 1000Ω for the various power cross tests)

Table 4.11 K.20 Power Cross Test Conditions for Telecom Type Ports, Metallic, and Longitudinal

Voltage Basic/Enhanced	Current (5x310 μ s) Basic/Enhanced (A)	Duration Basic/Enhanced	Repetitions *	Primary Protection	Acceptance Criteria Basic/Enhanced
600 V/600 V 50 Hz or 60 Hz	1/1	0.2 s	5	None	A/A
600/1.5 kV 50 Hz or 60 Hz	1/7.5	1 s/2 s	5	None	A/A
230/230 V 50 Hz or 60 Hz	23/23	15 min	1	None	B/B
	11.5/11.5				B/B
	5.75/5.75				B/B
	2.875/2.875				B/B
	1.44/1.44				B/A
	0.77/0.77				B/A
	0.38/0.38				B/A
0.23/0.23	B/B				

* One-minute rest between repetitions

Table 4.12 K.21 Lightning Test Conditions for Telecom Equipment on Customer Premises

Voltage (10x700 μ s)			Current (5x310 μ s) Basic/Enhanced (A)	Repetitions *	Primary Protection	Acceptance Criteria
Single Port		Multiple Ports Longitudinal Only				
Longitudinal (kV) Basic/Enhanced	Metallic (kV) Basic/Enhanced	Longitudinal Only (kV) Basic/Enhanced				
1.5/6 **			37.5/150	± 5	None	A ***
4/6			100/150	± 5	Installed if used	A
	1.5/1.5	1.5/1.5	37.5/37.5	± 5	None	A ***
	4/6	4/6	100/150	± 5	Installed if used	A

* One-minute rest between repetitions

** Reduce to 1.5 kV if SPD connects to GRD.

*** Does not apply if primary protectors are used.

Table 4.13 K.21 Power Cross Test Conditions for Telecom Type Ports, Metallic, and Longitudinal

Voltage Basic/Enhanced	Current Basic/Enhanced (A)	Duration Basic/Enhanced	Repetitions *	Primary Protection	Acceptance Criteria Basic/Enhanced
600 V / 600 V 50 Hz or 60 Hz	1/1	0.2 s	5	None	A/A
600 V / 1.5 kV 50 Hz or 60 Hz	1/7.5	1 s/2 s	5	Installed if used	A/A
230 V / 230 V 50 Hz or 60 Hz	23/23	15 min	1	None	B/B
	11.5/11.5				B/B
	5.75/5.75				B/B
	2.875/2.875				B/B
	1.44/1.44				B/A
	0.77/0.77				B/A
	0.38/0.38				B/A
	0.23/0.23				B/B

* One-minute rest between repetitions

TIA-968 (formerly known as FCC Part 68)

TIA-968 applies to all terminal equipment connected to the Public Switched Telephone Network (PSTN) and holds the “rule of law” by congressional order.

The purpose of TIA-968 is to provide a set of uniform standards to protect the telephone network from any damage or interference caused by the connection of terminal equipment. This standard includes environmental simulations such as vibration tests, temperature and humidity cycling, drop tests and tests for hazardous voltages and currents, as well as tests for signal power levels, line balance, on-hook impedance, and billing protection. All these standards must be met before and after the environmental tests are applied.

Overvoltage Test

TIA-968 compliant equipment must undergo an overvoltage test that includes a Type A and Type B Metallic Voltage Surge and a Type A and Type B Longitudinal Voltage Surge. These surges are part of the environmental simulation, and although a provision does allow the EUT to reach an open circuit failure mode during the Type A tests, failures must:

1. Arise from an intentional design that will cause the phone to be either disconnected from the public network or repaired rapidly
2. Be designed so that it is substantially apparent to the end user that the terminal equipment is not operable
A common example of an acceptable failure would be an open circuit due to an open connection on either Tip or Ring.

For Type B surges, equipment protection circuitry is not allowed to fail. The EUT must be designed to withstand Type B surges and continue to function in all operational states.

Metallic Voltage Surge

The Type A and Type B Metallic Voltage Surges are applied in both the positive and negative polarity across Tip and Ring during all operational states (on-hook, off-hook, ringing, and so on). The Type A surge is an 800 V, 100 A peak surge while the Type B surge is a 1000 V, 25 A peak surge, as presented in Table 4.14.

Table 4.14 TIA-968 Voltage Surge

Surge Type	Peak Voltage (V _{PK})	Rise & Decay Time (Voltage Waveform)	Peak Current (A)	Rise & Decay Time (Current Waveform)	Repetitions Each Polarity
Metallic A	±800	10x560 μs	100	10x560μs	1
Longitudinal A	±1500	10x160 μs	200	10x160μs	1
Metallic B	±1000	9x720 μs	25	5x320μs	1
Longitudinal B	±1500	9x720 μs	37.5	5x320μs	1

Notes:

- For Type A surges, the EUT may pass either “operationally” or “non-operationally.”
- For Type B surges, the EUT must pass “operationally.”
- The peak current for the Type A longitudinal surge is the total available current from the surge generator.
- The peak current for the Type B longitudinal surge is the current supplied to each conductor.

Longitudinal Voltage Surge

The Type A and Type B Longitudinal Voltage Surges are applied in both positive and negative polarity during all operational states. The Type A surge is a 1500 V, 200 A peak surge applied to the EUT with Tip and Ring tied together with respect to Ground. The Type B Longitudinal Voltage Surge is a simultaneous surge in which 1500 V and 37.5 A are applied concurrently to Tip with respect to Ground and Ring with respect to Ground, as presented in Table 4.14.

Note: Type B surge requirements guarantee only a minimum level of surge protection. For long term reliability of terminal equipment, consideration should be given to complying with Type A surges operationally.

On-hook Impedance Limitations

Another important aspect of TIA-968 is on-hook impedance, which is affected by transient protection. On-hook impedance is analogous to the leakage current between Tip and Ring, and Tip, Ring, and Ground conductors during various on-hook conditions. "On-hook Impedance Measurements" (next paragraph) outlines criteria for on-hook impedance and is listed as part of the Ringer Equivalent Number (REN). The REN is the largest of the unitless quotients not greater than five; the rating is specified as the actual quotient followed by the letter of the ringer classification (for example, 2B).

On-hook Impedance Measurements

On-hook impedance measurements are made between Tip and Ring and between Tip and Ground and Ring and Ground. For all DC voltages up to and including 100 V, the DC resistance measured must be greater than 5 M Ω . For all DC voltages between 100 V and 200 V, the DC resistance must be greater than 30 k Ω . The REN values are then determined by dividing 25 M Ω by the minimum measured resistance up to 100 V and by dividing 150 k Ω by the minimum measured resistance between 100 V and 200 V.

On-hook impedance is also measured during the application of a simulated ringing signal. This consists of a 40 V rms through 150 V rms ringer signal at frequencies ranging from 15.3 Hz to 68 Hz superimposed on a 56.5 V dc for a class "B" ringer. During this test, the total DC current may not exceed 3 mA. In addition, the minimum DC resistance measured between Tip and Ring must be greater than 1600 Ω , while the DC resistance measured between the Tip and Ring conductors and Ground must be greater than 100 k Ω . The REN values for the simulated ringing test are determined by dividing the maximum DC current flowing between Tip and Ring by 0.6 mA, and by dividing 8000 Ω by the minimum impedance value measured.

UL 60950 3rd Edition (formerly UL 1950, 3rd edition)

After the divestiture of the AT&T/Bell system, the National Electric Code (NEC) implemented Article 800-4, which mandates that "all equipment intended for connection to the public telephone network be listed for that purpose" in order to ensure electrical safety. A manufacturer can meet this requirement by listing their product with Underwriters Laboratories under UL 60950 (based on IEC 60950, 3rd edition).

NEC requires all telecommunication wiring that enters a building to pass through a primary protector, which is designed to limit AC transients in excess of 600 V rms. These transients are due to the fact that telephone lines run in close proximity to AC power lines. Most telecommunication equipment uses a secondary overvoltage protector such as the *SIDACtor* device. The secondary devices typically limit transients in excess of 350 V rms. Therefore, a potentially dangerous condition exists because of the voltage threshold difference of the primary protector and the secondary protector. To minimize this danger, compliance with UL 60950 overvoltage tests is required.

UL 60950 covers equipment with a rated voltage (primary power voltage) not exceeding 600 V and equipment designed to be installed in accordance with NEC NFPA 70. This standard does not apply to air-conditioning equipment, fire detection equipment, power supply systems, or transformers.

The effective date of UL 60950 allows new products submitted through April 1, 2003 to be evaluated using the requirements of either UL 60950 or UL 1950, 3rd edition. After April 1, 2003, all new product submittals must be evaluated using only UL 60950.

Products certified by UL to requirements of UL 1459 prior to April 1, 2000 may continue to be certified without further reinvestigation until April 1, 2005, provided no significant changes or revisions are made to the products. Products certified by UL to requirements of UL 1950 3rd edition prior to April 1, 2003 may continue to be certified without further reinvestigation until April 1, 2005.

In order to have the UL Mark applied after April 1, 2005, all products, including those previously certified by UL, must comply with UL 60950.

UL 60950 is intended to prevent injury or harm due to electrical shock, energy hazards, fire, heat hazards, mechanical hazards, radiation hazards, and chemical hazards.

It defines three classes of equipment:

- Class 1 — protection achieved by basic insulation
- Class 2 — protection achieved by double or reinforced insulation
- Class 3 — protection relying upon supply from SELV circuits (voltages up to 40 V peak or 60 V dc)

UL 60950 also defines five categories of insulation:

- Functional
- Basic
- Supplementary
- Reinforced
- Double

UL 60950 Terminology

The following definitions assist in understanding UL 60950:

SELV	Secondary circuit whose voltage values do not exceed a safe value (voltage less than hazardous levels of 42.4 V peak or 60 V dc)
TNV	Telecommunication Network Voltage (a secondary circuit)
TNV3	≥ SELV but with exposure to surges
TNV2	≥ SELV but without exposure to surges
TNV1	≤ SELV with exposure to surges

Creepage distance is the shortest distance between two conductors, measured along the surface of the insulation. DC voltages shall be included in determining the working voltage for creepage distances. (The peak value of any superimposed ripple or short disturbances, such as cadenced ringing signals, shall be ignored.)

Clearance distance is the shortest distance between two conductive parts or between a conductive part and the outer surface of the enclosure measured through air. DC voltages and the peak value of any superimposed ripple shall be included in determining the working voltage for clearance distances.

Creepage and clearance distances are also subject to the pollution degree of the equipment:

- Pollution degree 1 — components and assemblies that are sealed to prevent ingress of dust and moisture
- Pollution degree 2 — generally applicable to equipment covered by UL 60950
- Pollution degree 3 — equipment is subject to conductive pollution or to dry non-conductive pollution, which could become conductive due to expected condensation.

To ensure safe operating conditions of the equipment, UL 60950 focuses on the insulation rating of the circuit(s) under consideration. Table 4.15 and Table 4.16 indicate the required creepage and clearance distances depending on material group, pollution degree, working voltage, and maximum transient voltage in the secondary circuit. For a typical telecommunication application with a working voltage of 200 V, pollution degree 2, material group IIIb, the creepage distance is 2 mm. The clearance distance is 2 mm for reinforced insulation.

Table 4.15 Minimum Clearances in Secondary Circuits (millimeters)

Working Voltage up to and including	Nominal AC Mains Supply voltage ≤ 150 V (transient rating for Secondary Circuit 800 V)						Nominal AC Mains Supply voltage > 150 V ≤ 300 V (transient rating for Secondary Circuit 1500 V)						Nominal AC Mains Supply voltage > 300 V ≤ 600 V (transient rating for Secondary Circuit 2500 V)			Circuit Not Subject to Transient Overvoltages			
	Pollution Degrees 1 and 2			Pollution Degree 3			Pollution Degrees 1 and 2			Pollution Degree 3			Pollution Degrees 1, 2, and 3			Pollution Degrees 1 and 2 only			
	V *	V **	F	B/S	R	F	B/S	R	F	B/S	R	F	B/S	R	F	B/S	R	F	B/S
71	50	0.4	0.7	1.4	1	1.3	2.6	0.7	1	2	1	1.3	2.6	1.7	2	4	0.4	0.4	0.8
140	100	0.6	0.7	1.4	1	1.3	2.6	0.7	1	2	1	1.3	2.6	1.7	2	4	0.6	0.7	1.4
210	150	0.6	0.9	1.8	1	1.3	2.6	0.7	1	2	1	1.3	2.6	1.7	2	4	0.6	0.7	1.4
280	200	F 1.1; B/S 1.4; R 2.8												1.7	2	4	1.1	1.1	2.2
420	300	F 1.6; B/S 1.94; R 3.8												1.7	2	4	1.4	1.4	2.8

* Voltage peak or DC

** Voltage rms (sinusoidal)

Note: F = Functional

B/S = Basic/Supplementary

R = Reinforced

Table 4.16 Minimum Creepage Distances (millimeters)

Working Voltage V RMS or DC	Functional, Basic, and Supplementary Insulation							
	Pollution Degree 1		Pollution Degree 2			Pollution Degree 3		
	Material Group		Material Group			Material Group		
	I, II, IIIa, or IIIb		I	II	IIIa or IIIb	I	II	IIIa or IIIb
≤ 50	Use the Clearance from the appropriate table		0.6	0.9	1.2	1.5	1.7	1.9
100			0.7	1	1.4	1.8	2	2.2
125			0.8	1.1	1.5	1.9	2.1	2.4
150			0.8	1.1	1.6	2	2.2	2.5
200			1	1.4	2	2.5	2.8	3.2
250			1.3	1.8	2.5	3.2	3.6	4
300			1.6	2.2	3.2	4	4.5	5
400			2	2.8	4	5	5.6	6.3
600			3.2	4.5	6.3	8	9.6	10
800			4	5.6	8	10	11	12.5
1000	5	7.1	10	12.5	14	16		

Note: Linear interpolation is permitted between the nearest two points, the calculated spacing being rounded to the next higher 0.1 mm increment.

The following separations require the specified insulation grade:

- TNV3 from TNV3 — functional insulation
- TNV3 from SELV — basic insulation
- TNV3 from TNV1 — basic insulation
- TNV3 from TNV2 — basic insulation

The application must meet the creepage and clearance distances and electric strength of Section 5.3.2 of UL 60950 for functional insulation. The electric strength test (Table 5B of UL 60950) lists 1 kV to 1.5 kV as the test voltages for functional and supplementary grade of insulation and 2 kV to 3 kV for reinforced grade of insulation.

Separation requirements are tested (Section 6.2.2.1 of UL 60950) by applying an impulse test and an electric strength test:

- Impulse test allows for the *SIDACtor* device to turn on (either a 10x700 2.5 kV 62.5 A or 1 kV 37.5 A 10 times with 60-second rest period).
- Electric strength test allows the *SIDACtor* device to be removed (60 Hz at rated voltage for 60 seconds).

These are applied between Ground and all Tip and Rings connected together, and/or between Ground and all conductors intended to be connected to other equipment connected together.

Basic insulation is not required if all the following conditions are met:

- SELV, TNV1 circuit is connected to the protective earth.
- Installation procedures specify that protective earth terminal shall have a permanent connection to earth.
- Any TNV2 or TNV3 circuit with an external port connection intended to receive signals in excess of SELV (60 V dc or 50 V peak) will have the maximum normal expected operating voltage applied to it for up to 30 minutes without deterioration. (If no maximum normal specification exists then 120 V 100 mA 60 Hz is applied.)

(In other words, if a permanent Ground connection is made, then creepage distances may not be required.)

Any surge suppressor that bridges the insulation (connects to Ground) shall have a minimum DC turn on voltage of 1.6 times the rated voltage **UNLESS** one of the following occurs (Section 6.1.2.2 of UL 60950):

- Equipment is permanently connected or uses an industrial plug and socket-outlet.
- Equipment is installed by service personnel.
- Equipment has provision for a permanently connected protective earth.

ANNEX C of UL 60950 covers transformers.

The secondary side is loaded for maximum heating effect. The maximum working voltage is applied to the primary. The DC peak value of any superimposed ripple shall be included.

The permitted temperature limits for the windings depend on the classification:

- Class A limit is 150 °C.
- Class B limit is 175 °C.
- Class E limit is 165 °C.
- Class F limit is 190 °C.
- Class H limit is 210 °C.

Overvoltage Flowchart

The overvoltage flowchart in Figure 4.5 shows specific guidelines for determining overvoltage requirements applicable to specific designs.

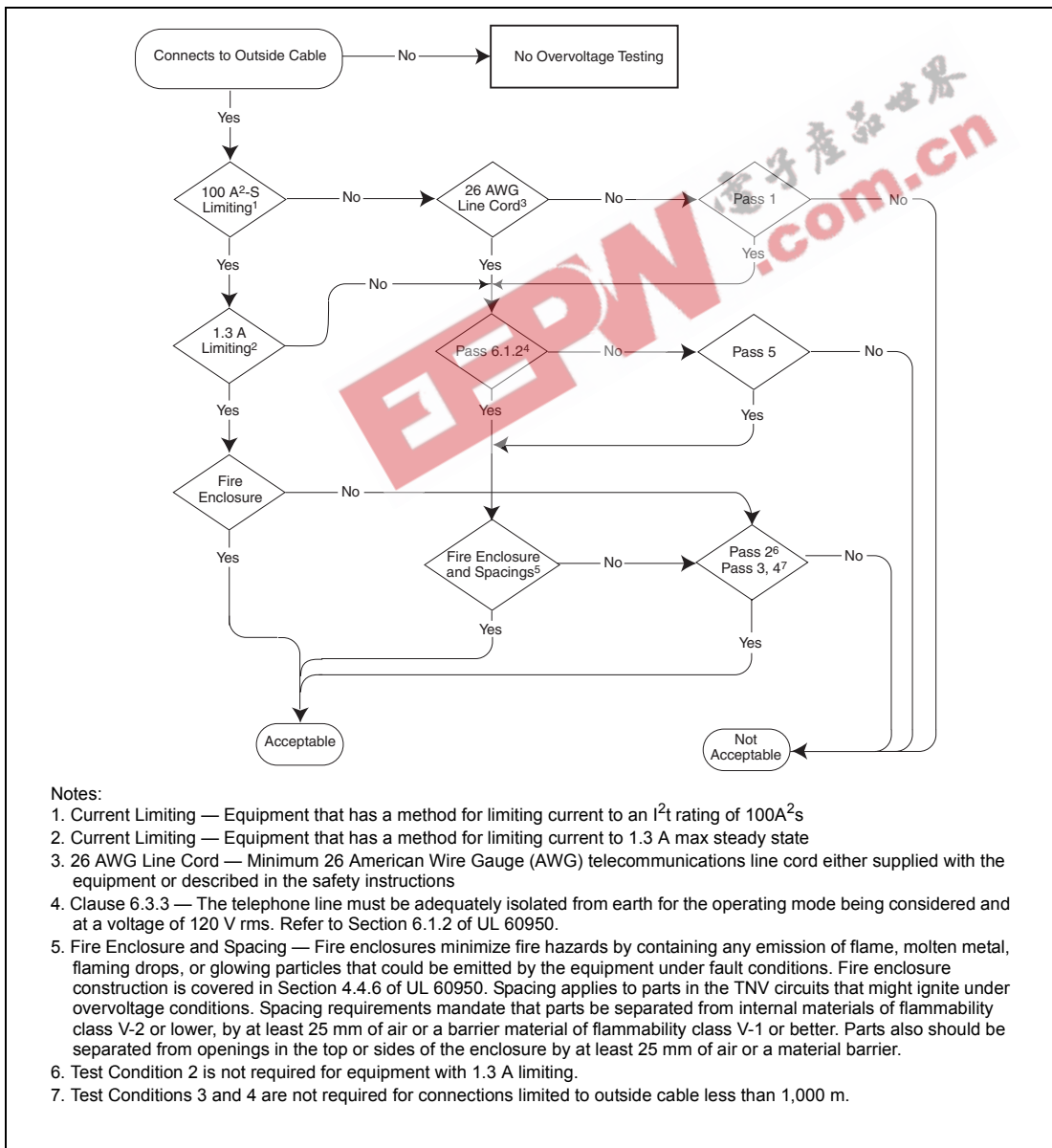

Figure 4.5 Overvoltage Flowchart

Passes 1, 2, 3, 4, and 5 shown in Figure 4.5 refer respectively to Tests L1 and M1, L2 and M2, L3 and M3, L4 and M4, and L5 shown in Table 4.17.

Equipment may be subject to the overvoltage tests shown in Table 4.17. The tests are designed to simulate the following:

- Contact with primary power
- Short-term induction as a result of a primary power fault to a multi-earth neutral
- Long duration power fault to Ground
- Direct contact between the power mains and a telecommunications cable

Table 4.17 UL 60950 Overvoltage Test

Test	Voltage (V _{RMS})	Current (A)	Time	Comments
L1	600 V	40	1.5 s	
L2	600 V	7	5 s	
L3	600 V	2.2	30 min	Reduce to 135% fuse rating
L4	200 V	2.2	30 min	Reduce to 135% fuse rating
L5	120 V	25	30 min	
M1	600 V	40	1.5 s	
M2	600 V	7	5 s	
M3	600 V	2.2	30 min	Reduce to 135% fuse rating
M4	600 V	2.2	30 min	Reduce to 135% fuse rating

Notes:

- ISDN S/T interface only L1, L2, L5, M1, and M2.
- Reduce to 135% rated value of fuse if Test 3 resulted in open condition.
- L4 and M4 are conducted only if SIDACTor $V_S \geq 285 V_S$ and then run at voltage level just below V_S .
- For test conditions M1, L1, M5, and L5 a wiring simulator (MDL 2 A fuse) is used.
- Compliance means no ignition or charring of the cheesecloth, and/or the wiring simulator does not open.
- If the secondary protector simulator is used (MDQ 1.6), it is allowed to open.
- Tests 2, 3, and 4 are required only if the unit is not a fire enclosure.
- Figure 4.6 and Figure 4.7 show the M (metallic) and L (longitudinal) test connections.

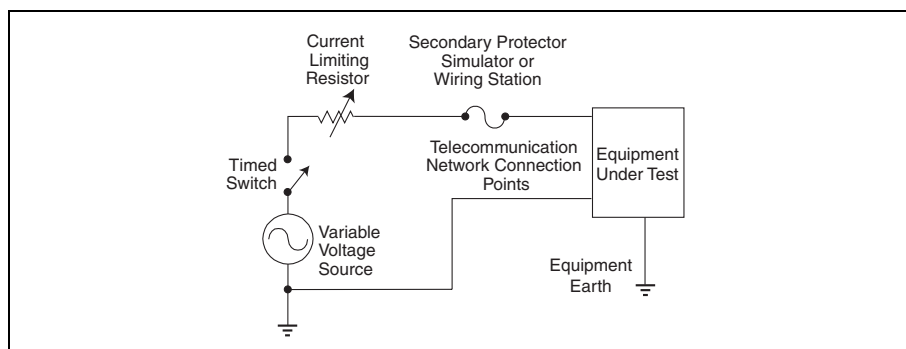

Figure 4.6 Metallic Connection Appearances

Regulatory Requirements

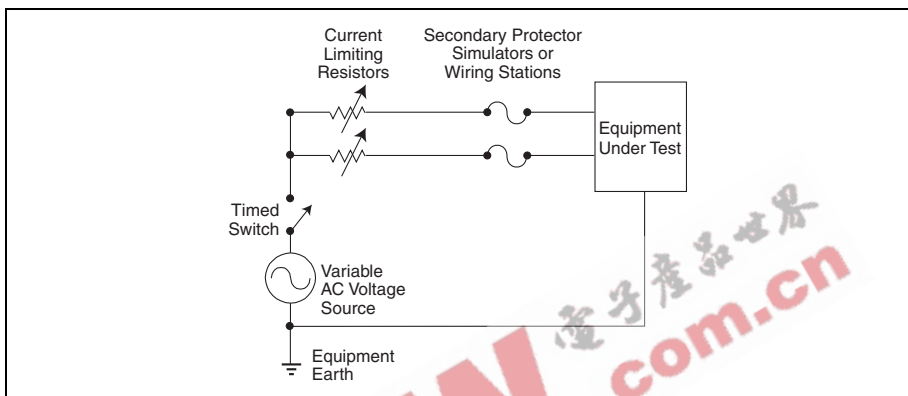

Figure 4.7 Longitudinal Connection Appearances

Overvoltage Test Procedures

Use the following criteria when applying the overvoltage tests presented in Table 4.17:

1. Test Set-up — Equipment is to be mounted as it is intended to be used. Tests may be conducted on either the equipment as an assembly, individual subassemblies, or a partial assembly containing those components which may be exposed to an overvoltage condition.
2. Indicators — Before testing, two single pieces of cheesecloth are to be wrapped tightly around the assembly, subassembly, or partial assembly. The cheesecloth acts as an indicator for conditions that may result in fire.
3. Line Cords — Equipment with a removable telecommunications line cord is to be connected to the test circuit with a line cord having 0.4 mm (26 AWG) or larger copper wire conductors and not more than 1 Ω total resistance.
4. Functional Circuitry — UL mandates that functional circuitry must be used for each overvoltage test conducted. This allows repair or replacement of damaged circuitry before subsequent testing. Alternatively, separate samples may be used for each test.
5. Wiring Simulators — A wiring simulator is used to indicate whether the maximum I²t imposed upon telecommunications wiring has been exceeded. For Tests 1 and 5, a wiring simulator is to be used unless the equipment is specified for use with a suitable secondary protector or a secondary protector simulator. The wiring simulator can consist of one of the following:
 - a. 50mm length of 0.2 mm (32 AWG) bare or enameled solid copper wire (for test condition 1)
 - b. Bussman Mfg. Co. Type MDL-2A fuse (for test condition 1)
 - c. 300 mm length of 0.4 mm (26 AWG) solid copper wire which connects to a representative installation (includes wiring and connectors)
[This option is used when the manufacturer specifies the complete installation from the network interface to the equipment.]
 - d. Current probe used with a 300 mm length of 0.5 mm (24 AWG) copper wire (for test condition 1)

Note: Test conditions 2, 3, and 4 do not require the use of a wiring simulator or a secondary protector simulator. Any secondary protection simulators used in Tests 1 and 5 should be similar to the test fuse used in UL 497A, "Standard for Secondary Protectors for Communications Circuits."

Overvoltage Test Compliance

Equipment is deemed compliant if each of the following conditions are met during test:

- Absence of ignition or charring of the cheesecloth indicator (Charring is deemed to have occurred when the threads are reduced to char by a glowing or flaming condition.)
- Wiring simulator does not open during test condition 1 or 5
- For test condition 1, presented in Table 4.17, the integral I^2t measured with a current probe is less than 100 A²s.

After completion of the overvoltage tests, equipment must comply with either the Dielectric Voltage-withstand Test requirements with all components in place or the Leakage Current Test requirements.

Special Considerations Regarding the SIDACtor Device and UL 60950

The epoxy used for SIDACtor devices is UL recognized and the encapsulated body passes UL 94V-0 requirements for flammability.

The only specific requirements of UL 60950 that pertain to the SIDACtor device itself are the impulse test and the mandate that components be UL recognized. All other UL 60950 requirements pertain to the equipment being evaluated.

UL 497

UL 497 Series of Safety Standards

The UL 497 series is a family of three safety standards that provides requirements for protection devices used in low-voltage circuits.

- UL 497 addresses requirements for primary protectors used in paired communications circuits.
- UL 497A covers secondary protectors for use in single or multiple pair-type communications circuits.
- UL 497B addresses protectors used in data communication and fire alarm circuits.
- UL 497C addresses protectors for coaxial circuits.

The focus of UL 497 is to ensure that paired communication circuit protectors do not become a fire or safety hazard. The requirements in UL 497 cover any protector that is designed for paired communications circuits and is employed in accordance with Article 800 of the National Electric Code. The protectors covered in UL 497 include solid state primary and station protectors. These circuit protectors are intended to protect equipment, wiring, and service personnel against the effects of excessive voltage potential and currents in the telephone lines caused by lightning, power cross, power induction, and rises in Ground potential.

UL 497 Construction and Performance Requirements

The "Construction" section covers the following requirements:

- General
- Enclosures
- Protection Against Corrosion
- Field-wiring Connections
- Components
- Spacing

The "Performance" section covers the following requirements:

- General
- Line Fuse Test
- Instrument Fuse Test
- Arrestor Test
- Polymeric Material Test
- Rubber Materials Test
- Corrosion Test, Outdoor Use Protector
- Jarring Test
- Water Spray Test
- Drop Test
- Cover Replacement Test
- Strain Relief Test
- Replacement Arrestors Installation Test
- Appliqué Assemblies Installation Test
- Dielectric Voltage-withstand Test
- Manufacturing and Production Tests
- Marking

Performance Tests

Key performance tests which concern overvoltage protectors are detailed in the arrester test section. Specific requirements are:

- **Breakdown Voltage Measurement** — Arrestors are to be tested in the protector blocks or panels in which they are intended to be employed. Arrestors are required to break down within $\pm 25\%$ of the manufacturer's specified breakdown rating. In no case shall the breakdown voltage exceed 750 V peak when subjected to the strike voltage test shown in Figure 4.8. At no time during this test will the supply voltage be increased at a rate greater than 2000 V/ μ s.
- **Impulse Spark-over Voltage Measurement** — The arrester must break down at less than 1000 V peak when subjected to a single impulse potential. Arrestors are to be tested in each polarity with a rate of voltage rise of 100 V/ μ s, $\pm 10\%$.
- **Abnormal Operation** — Single pair fuseless arrestors must be able to simultaneously carry 30 A rms at 480 V rms for 15 minutes without becoming a fire hazard. A fire hazard is determined by mounting the arrester on a vertical soft wood surface and covering the unit with cheesecloth. Any charring or burning of the cheesecloth results in test failure. During this test, although the arrestors may short, they must not have an impulse spark-over voltage or DC breakdown voltage greater than 1500 V peak.
- **Discharge Test** — Protectors must comply with the strike voltage requirements after being subjected to five successive discharges from a 2 μ F capacitor charged to 1000 V dc. (Figure 4.9).
- **Repeated Discharge Test** — The arrester must continue to break down at or below its maximum rated breakdown voltage after being subjected to 500 discharges from a 0.001 μ F capacitor charged to a potential of 10,000 V dc. The interval between pulses is five seconds. Arrestors are to be tested in each polarity, and it is acceptable for the protector to short circuit following the discharge testing. (Figure 4.9)

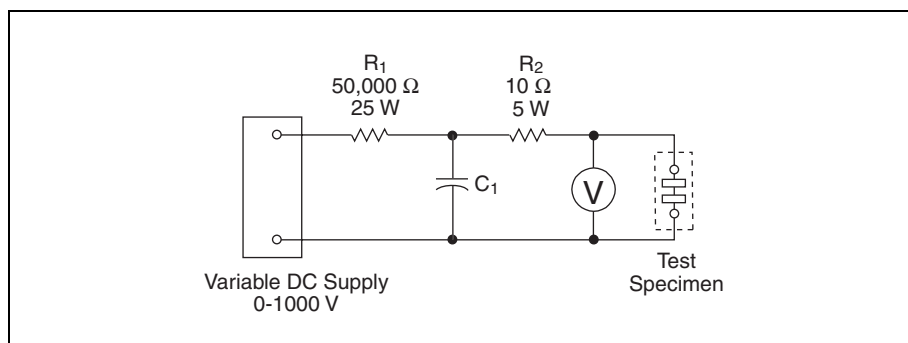

Figure 4.8 UL 497 Breakdown Voltage Measurement

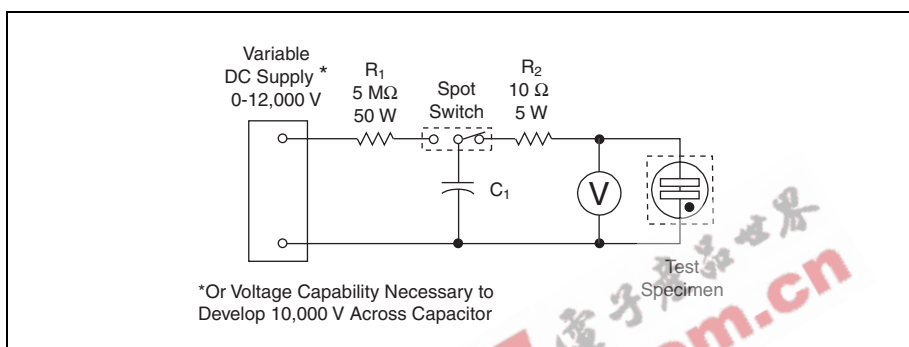

Figure 4.9 UL 497 Discharge Test

UL 497A

UL 497A addresses secondary protectors for use in single or multiple pair-type communication circuits intended to be installed in accordance with Article 800 of the National Electric Code and to have an operating voltage of less than 150 V rms with respect to Ground. The purpose of UL 497A is to help reduce the risk of fire, electric shock, or injury resulting from the deployment and use of these protectors. UL 497A requirements do not cover telephone equipment or key systems.

UL 497A Construction, Risk of Injury, and Performance Requirements

The "Construction" section covers the following requirements:

- General
- Product Assembly
- Enclosures
- Internal Material
- Accessibility and Electric Shock
- Protection Against Corrosion
- Cords
- Current-carrying Parts
- Internal Wiring
- Interconnecting Cords and Cables
- Insulating Material
- Printed Wiring
- Spacing

The "Risk of Injury" section covers the following requirements:

- Modular Jacks
- Sharp Edges
- Stability
- Protection of Service Personnel

The "Performance" section covers the following requirements:

- General
- Impulse Voltage Measurement
- Overvoltage Test
- Endurance Conditioning
- Component Temperature Test
- Drop Test
- Crush Test
- Leakage Current Test
- Dielectric Voltage-withstand Test
- Rain Test
- Maximum Moment Measurement Test
- Weather-o-meter and Micro Tensile Strength Test
- Thermal Aging and Flame Test
- Electric Shock Current Test
- Manufacturing and Production Line Test
- Marking, Installation, and Instructions

Performance Tests

The following key performance tests relate to overvoltage protection of the secondary protectors:

1. Impulse Voltage Measurement Test — Secondary protectors must break down within $\pm 25\%$ of the manufacturer's breakdown rating when tested in each polarity with a rate of voltage rise of $100 \text{ V}/\mu\text{s}$, $\pm 10\%$. Note that the manufacturer may assign separate breakdown voltage ratings for the Breakdown Voltage Measurement Test. This requirement only applies to secondary protectors that connect between Tip and Ring of the telephone loop.
2. Breakdown Voltage Measurement Test — Secondary protectors must break down within $\pm 25\%$ of the manufacturer's breakdown rating when tested in each polarity with a rate of voltage rise no greater than 2000 V/s . The secondary protector is to be mounted in accordance with the manufacturer's installation instructions and then subjected to the test circuit shown in Figure 4.10. This requirement applies only to secondary protectors connected between Tip and Ring or Tip/Ring and Ground of the telephone loop.
3. Overvoltage Test — Secondary protectors must limit current and extinguish or open the telephone loop without loss of its overvoltage protector, indication of fire risk, or electric shock. Upon completion of this test, samples must comply with the Dielectric Voltage-withstand Test.

The overvoltage test is used to determine the effects on secondary protectors and is shown in Table 4.18. Test connections are shown in Figure 4.11.

Test Compliance

Compliance with the overvoltage test is determined by meeting the following criteria:

- Cheesecloth indicator may not be either charred or ignited
- Wiring simulator (1.6 A Type MDQ fuse or 26 AWG line cord) may not be interrupted
- Protector meets the applicable dielectric voltage withstand requirements after the completion of the overvoltage tests

Table 4.18 UL 497A Overvoltage Test

Test	Voltage (V _{RMS})	Current (A)	Time	Connection
L1	600	40	1.5 s	(Note 1, Figure 4.11)
L2	600	7	5 s	(Note 1, Figure 4.11)
L3	600	2.2, 1, 0.5, 0.25	30 min at each current level	(Note 2, Figure 4.11)
L4	200 V rms or just below the breakdown voltage of the overvoltage protection device	2.2 A or just below the interrupt value of the current interrupting device	30 min	(Note 2, Figure 4.11)
L5	240	24	30 min	(Note 1, Figure 4.11)

Notes:

1. Apply Tests L1, L2, and L5 between Tip and Ground or Ring and Ground.
2. Apply Tests L3 and L4 simultaneously from both Tip and Ring to Ground.

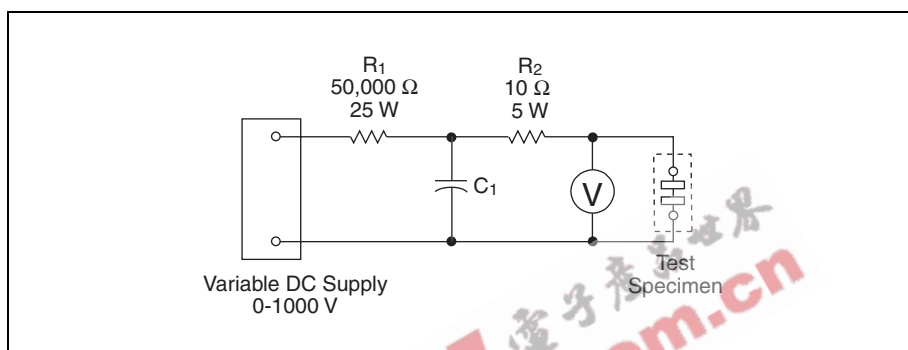

Figure 4.10 UL 497A Breakdown Voltage Measurement Test

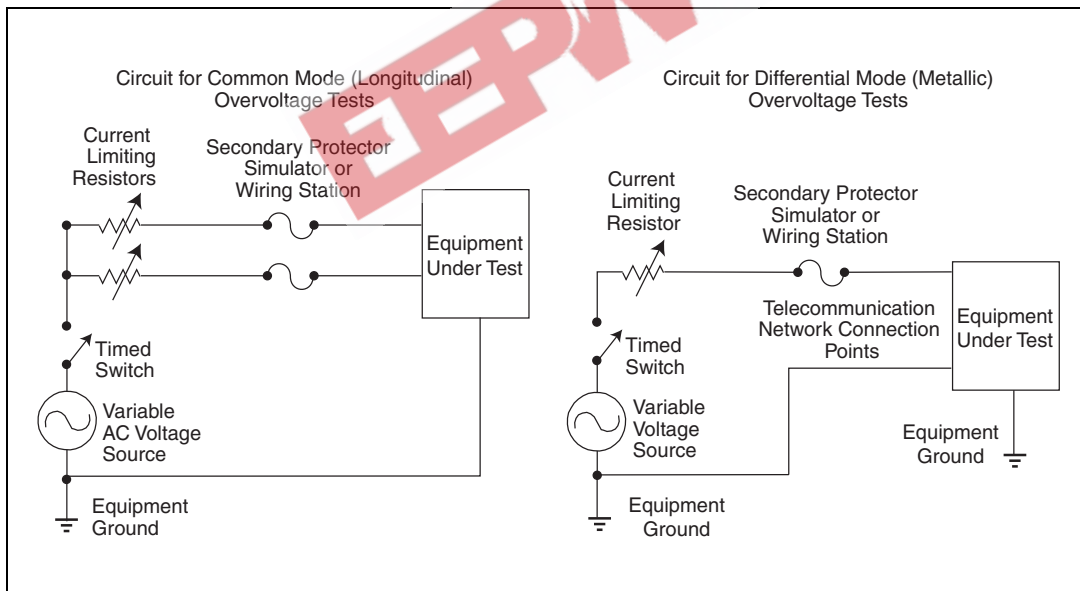

Figure 4.11 UL 497A Overvoltage Test

Regulatory Requirements

UL 497B

UL 497B provides requirements for protectors used in communication and fire alarm circuits. This standard does not cover devices for primary protection or protection devices used on telephone lines. *SIDACtor* devices are components recognized in accordance with UL 497B under UL file number E133083.

Construction and Performance Requirements

The “Construction” section covers the following requirements:

- General
- Corrosion Protection
- Field-wiring Connections
- Components
- Spacing
- Fuses

The “Performance” section covers the following requirements:

- General
- Strike Voltage Breakdown
- Endurance Conditioning
- Temperature Test
- Dielectric Voltage-withstand Test
- Vibration Conditioning
- Jarring Test
- Discharge Test
- Repeated Discharge Test
- Polymeric Materials Test
- High Temperature Test
- Marking

Performance Requirements Specific to *SIDACtor* Devices

1. Strike Voltage Breakdown Test — Protectors are required to break down within the manufacturer’s specified breakdown range or within 10% of a nominal single breakdown voltage rating. (Figure 4.12)
2. Endurance Conditioning — Protectors are subjected to 50 impulse cycles. Each cycle is a 1000 V peak, 10 A, 10x1000 μ s pulse. Pulses are applied in one polarity at 10-second intervals and then repeated in the opposite polarity.
3. Variable Ambient Conditioning — Protectors must comply with the strike voltage requirements after being subjected to an ambient temperature of 0 °C for four hours and again after being subjected to an ambient temperature of 49 °C for an additional four hours.
4. Discharge Test — Protectors must comply with strike voltage requirements after being subjected to five successive discharges from a 2 μ F capacitor charged to 1000 V dc. (Figure 4.13)
5. Repeated Discharge Test — Protectors must not break down at a voltage higher than the manufacturer’s maximum rated breakdown voltage nor lower than rated stand-off

voltage after being subjected to 500 discharges from a 0.001 μF capacitor charged to 10,000 V dc. The discharges are applied in five-second intervals between one side of the protector and Ground. Upon completion of the discharge tests, protectors are once again required to meet the strike voltage requirement. (Figure 4.13)

Note: The epoxy used to construct a *SIDACtor* device body meets UL 94V-0 requirements for flammability.

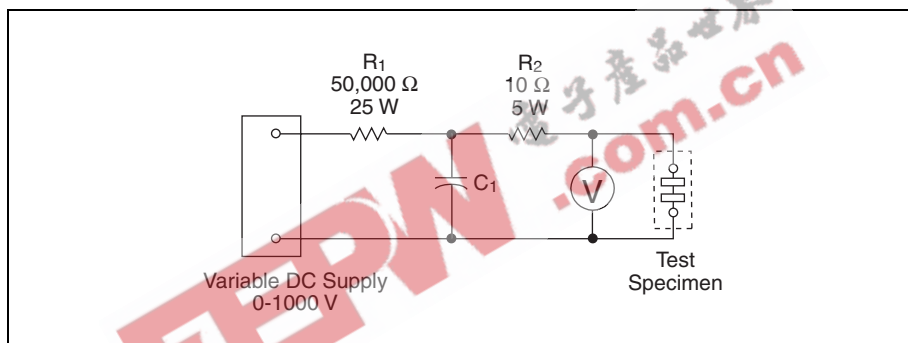

Figure 4.12 UL 497B Strike Voltage Breakdown Test

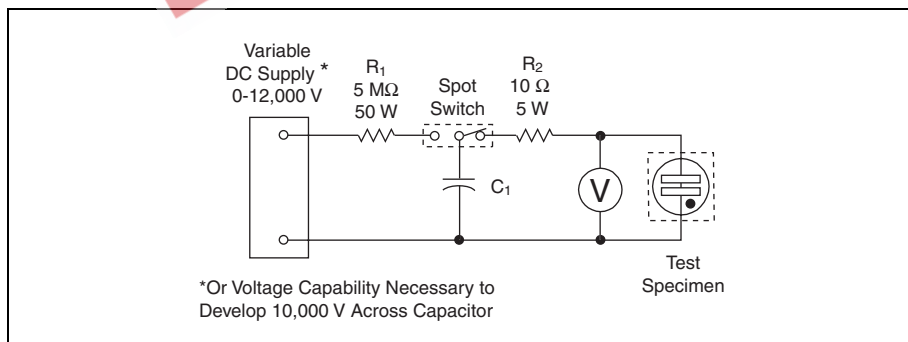

Figure 4.13 UL 497B Discharge Test

Regulatory Requirements

UL 497C

UL 497C requirements cover protectors for use on coaxial cable circuits. This standard covers construction and performance requirements.

UL 497C Construction and Performance Requirements

The "Construction" section covers the following requirements:

- General
- Corrosion Protection
- Field-wiring Connections
- Components
- Spacing
- Enclosures

The "Performance" section covers the following requirements:

- General
- I²t Limiting
- Abnormal Sustained Current
- Component Temperature Test
- Breakdown Voltage Measurement
- Impulse Spark-over Voltage Measurement
- Limited Short-circuit Test
- High Current Ground Path Test
- Cable Shield Fuse Test
- Endurance Conditioning Test
- Induced Low Current Test
- Distortion Test
- Flame Test
- Impact Test (Polymeric Enclosures)
- Jarring Test
- Water Spray Test
- Leakage Current Test
- Dielectric Voltage-withstand Test
- Ultraviolet Light and Water Exposure
- Tensile Strength and Elongation Tests
- Air Oven Aging
- Ozone Exposure

Performance Requirements Specific to SIDACtor Devices

1. Strike Voltage Breakdown Test — Protectors are required to break down within $\pm 25\%$ of the manufacturer's specified breakdown range but no higher than 750 V at ≤ 2 kV/s rise time.
2. Endurance Conditioning — Protectors are subjected to 500 impulse cycles. Each cycle is a 1000 V peak, 10 A, 10x1000 μ s pulse. Pulses are applied in one polarity at 10-second intervals and then repeated in the opposite polarity. Then, 100 cycles of 1000 V peak, 100 A, 10x1000 μ s pulse are applied to three new protectors. Finally, two cycles of

1000 V peak, 5000 A, 8x20 μ s pulse are applied to three new protectors, with a rest period of one minute between surges.

3. Variable Ambient Conditioning — Protectors must comply with the strike voltage requirements after being subjected to an ambient temperature of 25 °C for four hours and again after being subjected to an ambient temperature of 90 °C for an additional four hours.
4. Discharge Test — Protectors must comply with strike voltage requirements after being subjected to a discharge of 1000 V, 100 \pm 10 V/ μ s, 10 A impulse.

EEPW 电子产品世界
.com.cn

Regulatory Compliant Solutions

When determining the most appropriate solution to meet the lightning and AC power fault conditions for regulatory requirements, coordination is essential between the *SIDACtor* device, fuse, and any series impedance that may be used.

Figure 4.14 through Figure 4.19 show templates in which this coordination is considered for the most cost effective and reliable solutions available. For exact design criteria and information regarding the applicable regulatory requirements, refer to the *SIDACtor* device and fuse selection criteria in this Section 4, "Regulatory Requirements", and in Section 5, "Technical Notes".

GR 1089 and ITU-T K.20 and K.21

Figure 4.14 and Figure 4.15 show line interface protection circuits to meet GR 1089 surge immunity requirements without the additional use of series resistance. Use the "C" series *SIDACtor* device and F1250T to meet GR 1089 surge immunity requirements. Use the "A" series *SIDACtor* device and F0500T to meet ITU-T K.20 and K.21 basic surge immunity requirements without the additional use of resistance.

The enhanced surge immunity requirements of ITU K.20 and K.21 require the use of "C" rated *SIDACtor* devices if no series resistor is used.

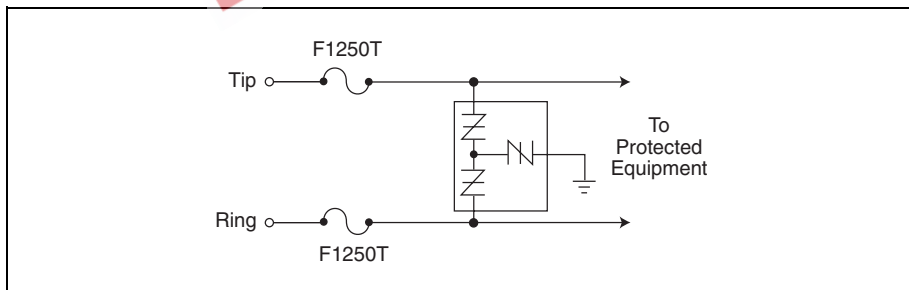

Figure 4.14 Balanced Line Protection using Teccor's "AC" or "AA" series

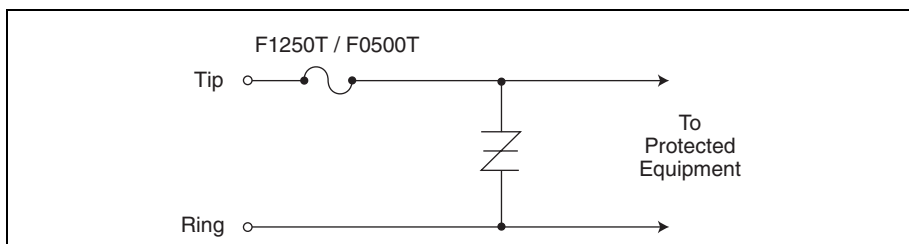

Figure 4.15 Metallic-only Solution using Teccor's "SC" or "SA" series.

TIA-968 (formerly known as FCC Part 68) and UL 60950

Because equipment that is tested to TIA-968 (formerly known as FCC Part 68) specifications is also generally tested to UL 60950 specifications, it is easiest to look at a solution that meets both FCC and UL requirements simultaneously.

TIA-968 Operational Solution and UL 60950

Figure 4.16 and Figure 4.17 show line interface protection circuits that meet UL 60950 power cross requirements and pass TIA-968 Type A and Type B lightning immunity tests operationally.

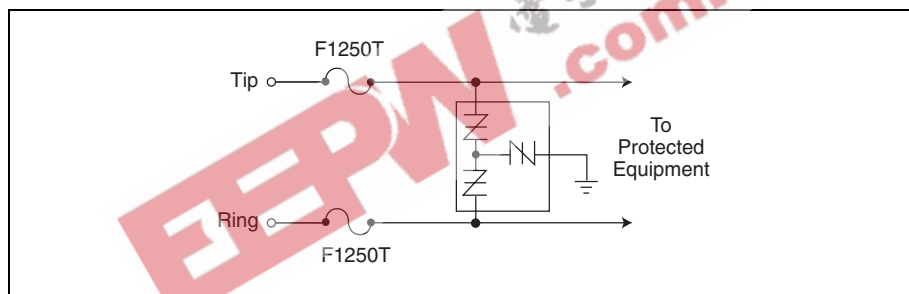

Figure 4.16 Balanced Line Protection using Teccor's "AC" Series

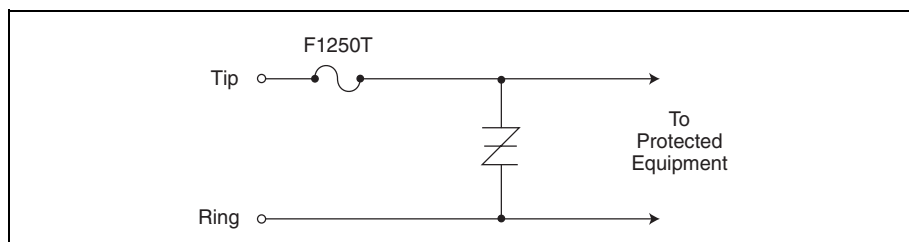

Figure 4.17 Metallic-only Solution using Teccor's "SB" or "EB" Series

Regulatory
Requirements

TIA-968 Non-Operational Solution and UL 60950

Although the circuits shown in Figure 4.16 and Figure 4.17 provide an operational solution for TIA-968, TIA-968 allows telecommunications equipment to pass Type A surges non-operationally as well. For non-operational TIA-968 solutions, coordinate the I_{PP} rating of the *SIDACtor* device and the I^2t rating of the fuse so that both will withstand the TIA-968 Type B surge, but that during the Type A surge the fuse will open.

Figure 4.18 and Figure 4.19 are line interface protection circuits that meet UL power cross requirements and pass TIA-968 lightning immunity surge A tests "non-operationally".

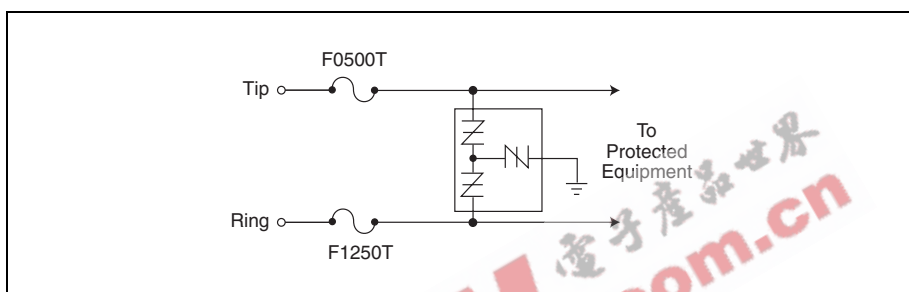

Figure 4.18 Balanced Line Protection using Teccor's "AA" Series

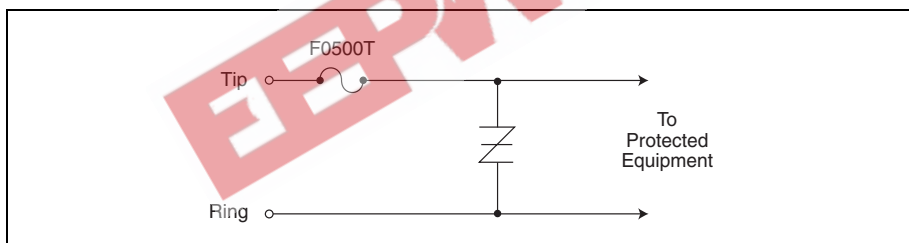

Figure 4.19 Metallic-only Solution using Teccor's "SA" or "EA" Series

Surge Waveforms for Various Standards

TIA-968 now replaces FCC Part 68, except for hearing aid compatibility (HAC), volume control, and indoor cabling. This has become harmonized with Canadian requirements. Various countries around the world have adopted this regulation.

GR 1089 is a standard generally supported by the US Regional Bell Operating Companies (RBOC). It is updated by Telcordia Technology (formerly Bellcore). The RBOC typically requires compliance with GR 1089 for any of their telecom purchases.

ITU is a specialized agency of the UN devoted to international harmonization. Most European countries recognize the ITU standards.

CNET is the Centre National d'études de Telecommunications, a French organization.

VDE is the Verband Deutscher Elektrotechniker, a Federation of German electrical engineers. VDE is very similar to the IEEE (Institute of Electrical and Electronics Engineers) but is national in scope rather than global.

ANSI is the American National Standards Institute, which is a non-government organization. The British equivalent to this is BSI.

IEC is the International Electrotechnical Commission, a result of Europe's move toward a single market structure and its drive to formalize and harmonize member countries' requirements.

FTZ R12 is a German specification.

Table 4.19 and Table 4.20 show the recommended *SIDACtor* device surge rating for each standard.

Surge Waveforms for Various Standards

Table 4.19 Surge Waveforms for Various Standards

Standard		Voltage	Voltage Waveform	Current	Current Waveform	SIDACtor Device
		Volts	µs	Amps	µs	w/o series R
TIA-968 (formerly known as FCC Part 68)	Surge A Metallic	800	10x560	100	10x560	B or C
	Surge A Longitudinal	1500	10x160	200	10x160	C
	Surge B Metallic	1000	9x720	25	5x320	A, B, or C
	Surge B Longitudinal	1500	9x720	37.5	5x320	A, B, or C
GR 1089	Test 1	600	10x1000	100	10x1000	C
	Test 2	1000	10x360	100	10x360	B or C
	Test 3	1000	10x1000	100	10x1000	C
	Test 4	2500	2x10	500	2x10	C
	Test 5	1000	10x360	25	10x360	A, B, or C
ITU K.17		1500	10x700	37.5	5x310	A, B, or C
RLM 88, CNET		1500	0.5x700	38	0.2x310	A, B, or C
CNET 131-24		1000	0.5x700	25	0.8x310	A, B, or C
VDE 0433		2000	10x700	50	5x310	A, B, or C
VDE 0878		2000	1.2x50	50	1x20	A, B, or C
IEC 61000-4-5		2 kV	10x700	50	5x310	A, B, or C
		4 kV	10x700	100	8x20	C
FTZ R12		2000	10x700	50	5x310	A, B, or C

Table 4.20 Surge Waveforms for Various Standards

Standard		Voltage	Voltage Waveform	Current	Current Waveform	SIDACtor Device
		Volts Basic/Enhanced	µs	Amps Basic/Enhanced	µs Basic/Enhanced	w/o series R Basic/Enhanced
ITU K.20	Basic single port	1 kV/4 kV	10x700	25/100	5x310	A, B, C/B, C
	Enhanced single	1.5 kV/4 kV	10x700	37.5/100	5x310	A, B, C/B, C
	Basic multiple ports	1.5 kV/4 kV	10x700	37.5/100	5x310	A, B, C/B, C
	Enhanced multiple	1.5 kV/6 kV	10x700	37.5/100	5x310	A, B, C/C
	Basic power cross	600	50 Hz, 60 Hz	1	0.2 s	F1250T
	Enhanced power cross	600/1.5 kV	50 Hz, 60 Hz	1/7.5	0.2 s/2 s	F1250T *
ITU K.21	Basic single port	1.5 kV/4 kV	10x700	37.5/100	5x310	A, B, C/B, C
	Enhanced single	1.5 kV/6 kV	10x700	37.5/150	5x310	A, B, C/C
	Basic multiple ports	1.5 kV/4 kV	10x700	37.5/100	5x310	A, B, C/B, C
	Enhanced multiple	1.5 kV/6 kV	10x700	37.5/150	5x310	A, B, C/C
	Basic power cross	600	50 Hz, 60Hz	1	0.2 s	F1250T
	Enhanced power cross	600/1.5 kV	50 Hz, 60Hz	1/7.5	0.2 s/2 s	F1250T *

* At 7.5 A the F1250T will open, which is not allowed for enhanced requirements of ITU K.20 and K.21.

5

Technical Notes

This section is offered to help answer any questions not previously addressed in this data book regarding the *SIDACtor* device and its implementation.

Construction and Operation	5-3
SIDACtor Device Selection Criteria	5-5
Fuse Selection Criteria	5-8
Overvoltage Protection Comparison	5-10
Overcurrent Protection	5-14
PCB Layout	5-18
SIDACtor Soldering Recommendations	5-22
TeleLink Fuse Soldering	5-25
Telecommunications Protection	5-26
Lightning	5-27

EEPW 电子产品世界
 .com.cn

Construction and Operation

SIDACTor devices are thyristor devices used to protect sensitive circuits from electrical disturbances caused by lightning-induced surges, inductive-coupled spikes, and AC power cross conditions. The unique structure and characteristics of the thyristor are used to create an overvoltage protection device with precise and repeatable turn-on characteristics with low voltage overshoot and high surge current capabilities.

Key Parameters

Key parameters for *SIDACTor* devices are V_{DRM} , I_{DRM} , V_S , I_H , and V_T , as shown in Figure 5.1. V_{DRM} is the repetitive peak off-state voltage rating of the device (also known as stand-off voltage) and is the continuous peak combination of AC and DC voltage that may be applied to the *SIDACTor* device in its off-state condition. I_{DRM} is the maximum value of leakage current that results from the application of V_{DRM} . Switching voltage (V_S) is the maximum voltage that subsequent components may be subjected to during a fast-rising (100 V/ μ s) overvoltage condition. Holding current (I_H) is the minimum current required to maintain the device in the on state. On-state voltage (V_T) is the maximum voltage across the device during full conduction.

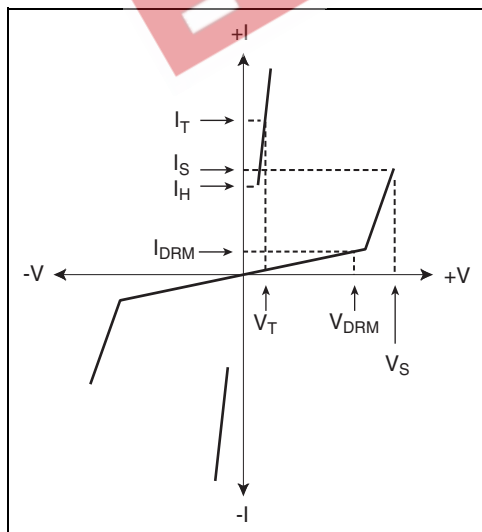

Figure 5.1 V-I Characteristics

Operation

The *SIDACTor* device operates much like a switch. In the off state, the device exhibits leakage currents (I_{DRM}) less than 5 μ A, making it invisible to the circuit it is protecting. As a transient voltage exceeds the *SIDACTor* device's V_{DRM} , the device begins to enter its protective mode with characteristics similar to an avalanche diode. When supplied with enough current (I_S), the *SIDACTor* device switches to an on state, shunting the surge from the circuit it is protecting. While in the on state, the *SIDACTor* device is able to sink large

amounts of current because of the low voltage drop (V_T) across the device. Once the current flowing through the device is either interrupted or falls below a minimum holding current (I_H), the *SIDACtor* resets, returning to its off state. If the I_{PP} rating is exceeded, the *SIDACtor* device typically becomes a permanent short circuit.

Physics

The *SIDACtor* device is a semiconductor device which is characterized as having four layers of alternating conductivity: PNPN. (Figure 5.2) The four layers include an emitter layer, an upper base layer, a mid-region layer, and a lower base layer. The emitter is sometimes referred to as a cathode region, with the lower base layer being referred to as an anode region.

As the voltage across the *SIDACtor* device increases and exceeds the device's V_{DRM} , the electric field across the center junction reaches a value sufficient to cause avalanche multiplication. As avalanche multiplication occurs, the impedance of the device begins to decrease, and current flow begins to increase until the *SIDACtor* device's current gain exceeds unity. Once unity is exceeded, the *SIDACtor* device switches from a high impedance (measured at V_S) to a low impedance (measured at V_T) until the current flowing through the device is reduced below its holding current (I_H).

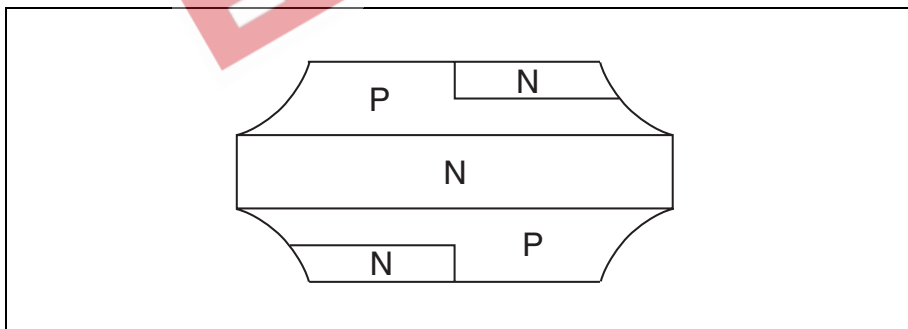

Figure 5.2 Geometric Structure of Bidirectional *SIDACtor* devices

SIDACtor Device Selection Criteria

When selecting a SIDACtor device, the following criteria should be used:

Off-state Voltage (V_{DRM})

The V_{DRM} of the SIDACtor device must be greater than the maximum operating voltage of the circuit that the SIDACtor device is protecting.

Example 1:

For a POTS (Plain Old Telephone Service) application, convert the maximum operating Ring voltage (150 V rms) to a peak voltage, and add the maximum DC bias of the central office battery:

$$150 V_{RMS} \sqrt{2} + 56.6 V_{PK} = 268.8 V_{PK}$$

$$\therefore V_{DRM} > 268.8 V$$

Example 2:

For an ISDN application, add the maximum voltage of the DC power supply to the maximum voltage of the transmission signal (for U.S. applications, the U-interface will not have a DC voltage, but European ISDN applications may):

$$150 V_{PK} + 3 V_{PK} = 153 V_{PK}$$

$$\therefore V_{DRM} > 153 V$$

Switching Voltage (V_S)

The V_S of the SIDACtor device should be equal to or less than the instantaneous peak voltage rating of the component it is protecting.

Example 1:

$$V_S \leq V_{Relay \text{ Breakdown}}$$

Example 2:

$$V_S \leq SLIC V_{PK}$$

Peak Pulse Current (I_{PP})

For circuits that do not require additional series resistance, the surge current rating (I_{PP}) of the SIDACtor device should be greater than or equal to the surge currents associated with the lightning immunity tests of the applicable regulatory requirement (I_{PK}):

$$I_{PP} \geq I_{PK}$$

For circuits that use additional series resistance, the surge current rating (I_{PP}) of the SIDACtor device should be greater than or equal to the available surge currents associated with the lightning immunity tests of the applicable regulatory requirement ($I_{PK(available)}$):

$$I_{PP} \geq I_{PK(available)}$$

The maximum available surge current is calculated by dividing the peak surge voltage (V_{PK}) by the total circuit resistance (R_{TOTAL}):

$$I_{PK(available)} = V_{PK}/R_{TOTAL}$$

For longitudinal surges (Tip-Ground, Ring-Ground), R_{TOTAL} is calculated for both Tip and Ring:

$$R_{SOURCE} = V_{PK}/I_{PK}$$

$$R_{TOTAL} = R_{TIP} + R_{SOURCE}$$

$$R_{TOTAL} = R_{RING} + R_{SOURCE}$$

For metallic surges (Tip-Ring):

$$R_{SOURCE} = V_{PK}/I_{PK}$$

$$R_{TOTAL} = R_{TIP} + R_{RING} + R_{SOURCE}$$

Example 1:

A modem manufacturer must pass the Type A surge requirement of TIA-968 (formerly known as FCC Part 68) without any series resistance.

$$I_{PK} = 100 \text{ A}, 10 \times 560 \mu\text{s}$$

$$I_{PP} \geq 100 \text{ A}, 10 \times 560 \mu\text{s}$$

Therefore, either a "B" rated or "C" rated *SIDACtor* device would be selected.

Example 2:

A line card manufacturer must pass the surge requirements of GR 1089 with 30 Ω on Tip and 30 Ω on Ring.

$$I_{PK} = 100 \text{ A}, 10 \times 1000 \mu\text{s}$$

$$V_{PK} = 1000 \text{ V}$$

$$R_{SOURCE} = V_{PK}/I_{PK} = 10 \Omega$$

$$R_{TOTAL} = R_{SOURCE} + R_{TIP} = 40 \Omega$$

$$I_{PK(available)} = V_{PK}/R_{TOTAL} = 1000 \text{ V}/40 \Omega$$

$$\therefore I_{PP} \geq 25 \text{ A}$$

Holding Current (I_H)

Because TIA-968 4.4.1.7.3 specifies that registered terminal equipment not exceed 140 mA dc per conductor under short-circuit conditions, the holding current of the *SIDACtor* device is set at 150 mA.

For specific design criteria, the holding current (I_H) of the *SIDACtor* device must be greater than the DC current that can be supplied during an operational and short circuit condition.

Off-State Capacitance (C_0)

Assuming that the critical point of insertion loss is 70% of the original signal value, the *SIDACtor* device can be used in most applications with transmission speeds up to 30 MHz. For transmission speeds greater than 30 MHz, the new MC series is highly recommended.

EEPW 电子產品世界
.com.cn

Fuse Selection Criteria

A fuse can be relied upon to operate safely at its rated current, at or below its rated voltage. This voltage rating is covered by the National Electric Code (NEC) regulations and is a requirement of UL as protection against fire risk. The standard voltage ratings used by fuse manufacturers for most small dimension fuses are 32 V, 63 V, 125 V, 250 V, and 600 V.

Fuses are not sensitive to changes in voltage; however, they are sensitive to changes in current. The fuse will maintain “steady-state” operation from zero volts to the maximum voltage rating. It is not until the fuse element melts and internal arcing occurs, that circuit voltage and available power become an issue. The interrupt rating of the fuse addresses this issue. Specifically, the voltage rating determines the ability of the fuse to suppress internal arcing that occurs after the fuse link melts.

For telecommunication applications, a voltage rating of 250 V is chosen because of the possibility of power line crosses. A three-phase voltage line will have voltage values up to 220 V. It is desirable for the voltage rating of the fuse to exceed this possible power cross event.

UL 60950 has a power cross test condition that requires a fuse to have an interrupt rating of 40 A at 600 V. GR 1089 contains a power cross test condition that requires a fuse to have an interrupt rating of 60 A at 600 V. A 125 V-rated part will not meet this requirement.

A 250 V part with special design consideration, such as Teccor's F1250T TeleLink fuse, does meet this requirement.

Because fuses are rated in terms of continuous voltage and current-carrying capacity, it is often difficult to translate this information in terms of peak pulse current ratings. To simplify this process, Table 5.1 shows the surge rating correlation to fuse rating.

Table 5.1 Surge Rating Correlation to Fuse Rating

Fuse Rating (mA)	Equivalent I _{pp} Rating		
	10x160 μs (A)	10x560 μs (A)	10x1000 μs (A)
250	30	15	10
350	45	25	20
400	50	30	25
500	65	35	30
600	75	45	35
750	90	65	50
1000	130	85	65
1250	160	115	100

Notes:

- The I_{pp} ratings apply to a 2AG (glass body) slow blow fuse only.
- Because there is a high degree of variance in the fusing characteristics, the I_{pp} ratings listed should only be used as approximations.

Peak Pulse Current (I_{PP})

For circuits that do not require additional series resistance, the surge current rating (I_{PP}) of the fuse should be greater than or equal to the surge currents associated with the lightning immunity tests of the applicable regulatory requirement (I_{PK}):

$$I_{PP} \geq I_{PK}$$

For circuits that use additional series resistance, the surge current rating (I_{PP}) of the fuse should be greater than or equal to the available surge currents associated with the lightning immunity tests of the applicable regulatory requirement ($I_{PK(available)}$):

$$I_{PP} \geq I_{PK(available)}$$

The maximum available surge current is calculated by dividing the peak surge voltage (V_{PK}) by the total circuit resistance (R_{TOTAL}):

$$I_{PK(available)} = V_{PK}/R_{TOTAL}$$

For longitudinal surges (Tip-Ground, Ring-Ground), R_{TOTAL} is calculated for both Tip and Ring:

$$R_{SOURCE} = V_{PK}/I_{PK}$$

$$R_{TOTAL} = R_{TIP} + R_{SOURCE}$$

$$R_{TOTAL} = R_{RING} + R_{SOURCE}$$

For metallic surges (Tip-Ring):

$$R_{SOURCE} = V_{PK}/I_{PK}$$

$$R_{TOTAL} = R_{TIP} + R_{RING} + R_{SOURCE}$$

Overvoltage Protection Comparison

The four most commonly used technologies for overvoltage protection are:

- *SIDACtor* devices
- Gas Discharge Tubes (GDTs)
- Metal Oxide Varistors (MOVs)
- TVS diodes

All four technologies are connected in parallel with the circuit being protected, and all exhibit a high off-state impedance when biased with a voltage less than their respective blocking voltages.

SIDACtor devices

A *SIDACtor* device is a PNPN device that can be thought of as a TVS diode with a gate. Upon exceeding its peak off-state voltage (V_{DRM}), a *SIDACtor* device will clamp a transient voltage to within the device's switching voltage (V_S) rating. Then, once the current flowing through the *SIDACtor* device exceeds its switching current, the device will crowbar and simulate a short-circuit condition. When the current flowing through the *SIDACtor* device is less than the device's holding current (I_H), the *SIDACtor* device will reset and return to its high off-state impedance.

Advantages

Advantages of the *SIDACtor* device include its fast response time (Figure 5.3), stable electrical characteristics, long term reliability, and low capacitance. Also, because the *SIDACtor* device is a crowbar device, it cannot be damaged by voltage and it has extremely high surge current ratings.

Restrictions

Because the *SIDACtor* device is a crowbar device, it cannot be used directly across the AC line; it must be placed behind a load. Failing to do so will result in exceeding the *SIDACtor* device's surge current rating, which may cause the device to enter a permanent short-circuit condition.

Applications

Although found in other applications, *SIDACtor* devices are primarily used as the principle overvoltage protector in telecommunications and data communications circuits. For applications outside this realm, follow the design criteria in "SIDACtor Device Selection Criteria" on page 5-5.

Gas Discharge Tubes

Gas tubes are either glass or ceramic packages filled with an inert gas and capped on each end with an electrode. When a transient voltage exceeds the DC breakdown rating of the device, the voltage differential causes the electrodes of the gas tube to fire, resulting in an arc, which in turn ionizes the gas within the tube and provides a low impedance path for the

transient to follow. Once the transient drops below the DC holdover voltage and current, the gas tube returns to its off state.

Advantages

Gas tubes have high surge current and low capacitance ratings. Current ratings can be as high as 500 A for 200 impulses, and capacitance ratings can be as low as 1 pF with a zero-volt bias.

Restrictions

Gas tubes have a limited shelf life and their performance degrades with usage. Out of the four devices discussed, gas tubes exhibit the slowest response time and highest peak voltage measurement. (Figure 5.3)

Applications

Because gas tubes are large and require a substantial amount of time to reach full conduction, they are rarely used as board-level components. Consequently, gas tubes are not normally used in telecommunications applications other than station protection modules.

Metal Oxide Varistors

Metal Oxide Varistors (MOVs) are two-leaded, through-hole components typically shaped in the form of discs. Manufactured from sintered oxides and schematically equivalent to two back-to-back PN junctions, MOVs shunt transients by decreasing their resistance as voltage is applied.

Advantages

Since MOVs surge capabilities are determined by their physical dimensions, high surge current ratings are available. Also, because MOVs are clamping devices, they can be used as transient protectors in secondary AC power line applications.

Restrictions

Like gas tubes, MOVs have slow response times resulting in peak clamping voltages which can be greater than twice the device's voltage rating. (Figure 5.3) MOVs also have long-term reliability and performance issues due to their tendency to fatigue, high capacitance, and limited packaging options.

Applications

Although MOVs are restricted from use in many telecom applications (other than disposable equipment), they are useful in AC applications where a clamping device is required and tight voltage tolerances are not.

TVS Diodes

Transient Voltage Suppressor (TVS) diodes are clamping voltage suppressors that are constructed with back-to-back PN junctions. During conduction, TVS diodes create a low impedance path by varying their resistance as voltage is applied across their terminals. Once the voltage is removed, the diode will turn off and return to its high off-state impedance.

Advantages

Because TVS diodes are solid state devices, they do not fatigue nor do their electrical parameters change as long as they are operated within their specified limits. TVS diodes effectively clamp fast-rising transients and are well suited for low-voltage applications that do not require large amounts of energy to be shunted.

Restrictions

Because TVS diodes are clamping devices, they have two inherent weaknesses. First, TVS diodes are both voltage- and current-limited, so careful consideration should be given to using these in applications that require large amounts of energy to be shunted. Secondly, as the amount of current flowing through the device increases, so does its maximum clamping voltage.

Applications

Due to their low power ratings, TVS diodes are not used as primary interface protectors across Tip and Ring; they are used as secondary protectors that are embedded within a circuit.

dv/dt Chart

Figure 5.3 shows a peak voltage comparison between *SIDACtor* devices, gas discharge tubes, MOVs, and TVS diodes, all with a nominal stand-off voltage rating of 230 V. The X axis represents the dv/dt (rise in voltage with respect to time) applied to each protector, and the Y axis represents the maximum voltage drop across each protector.

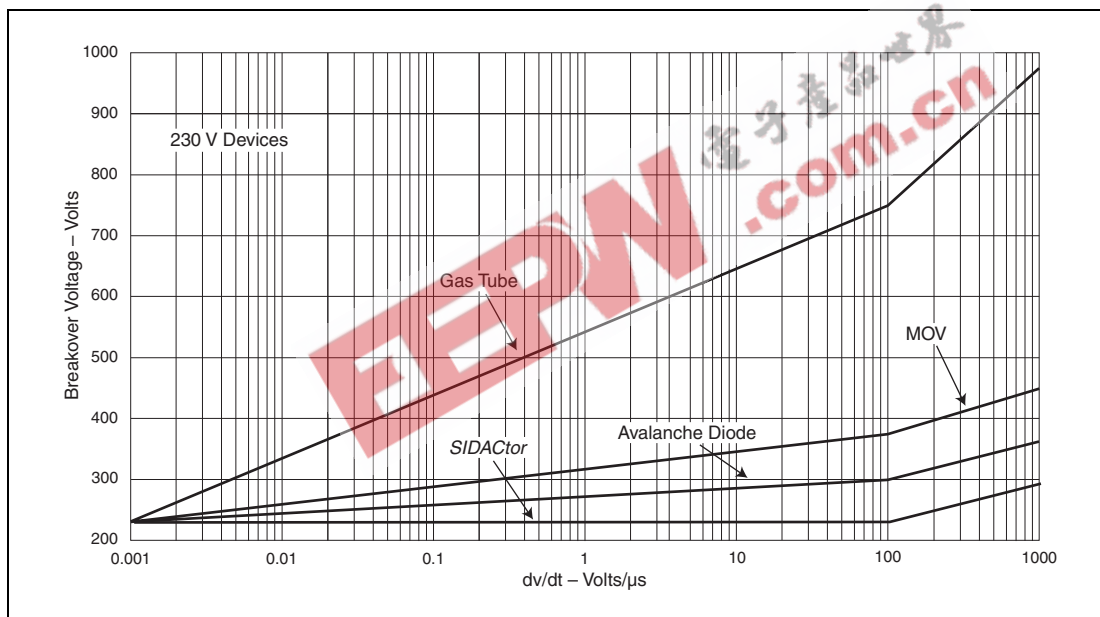

Figure 5.3 Overshoot Levels versus dv/dt

Technical Notes

Overcurrent Protection

In addition to protecting against overvoltage conditions, equipment should also be protected from overcurrent conditions using either PTCs, fuses, power/line feed resistors, or flameproof resistors. In all instances the overcurrent protector is a series element placed in front of the overvoltage protector on **either** Tip **or** Ring for metallic (closed loop) applications and on **both** Tip **and** Ring for longitudinal (grounded) applications.

PTCs

PTCs are positive temperature coefficient thermistors used to limit current. During a fault condition, heat is generated at a rate equal to I^2R . When this heat becomes sufficient, the PTC increases its resistance asymptotically until the device simulates an open circuit, limiting the current flow to the rest of the circuit. As the fault condition drops below the PTC's holding current, the device begins to reset, approximating its original off-state value of impedance.

Advantages

Because PTCs are resettable devices, they work well in a variety of industrial applications where electrical components cannot withstand multiple, low-current faults.

Restrictions

Although PTCs are well suited for the industrial environment and in many telecom applications, they exhibit some limitations that have prevented them from being endorsed by the entire telecommunications industry. Limitations include low surge current ratings, unstable resistance, and poor packaging options.

Applications

PTCs are used in a variety of applications. In addition to protecting telecommunications equipment, PTCs are also used to prevent damage to rechargeable battery packs, to interrupt the current flow during a motor lock condition, and to limit the sneak currents that may cause damage to a five-pin module.

Fuses

Due to their stability, fuses are one of the most popular solutions for meeting AC power cross requirements for telecommunications equipment. Similar to PTCs, fuses function by reacting to the heat generated due to excessive current flow. Once the fuses I^2t rating is exceeded, the center conductor opens.

Advantages

Fuses are available in both surface mount and through-hole packages and are able to withstand the applicable regulatory requirements without the use of any additional series impedance. Chosen correctly, fuses only interrupt a circuit when extreme fault conditions exist and, when coordinated properly with an overvoltage protector, offer a very competitive and effective solution for transient immunity needs.

Advantages include:

- Elimination of series line resistance enabling longer loop lengths
- Precise longitudinal balance allowing better transmission quality
- Robust surge performance which eliminates costly down time due to nuisance blows
- Greater surge ratings than resettable devices, ensuring regulatory compliance
- Non-degenerative performance
- Available in surface mount packaging which uses less Printed Circuit Board (PCB) real estate, eliminates mixed technologies, and reduces manufacturing costs

Weaknesses

Because a fuse does not reset, consideration should be given to its use in applications where multiple fault occurrences are likely. For example, AC strip protectors and ground fault interrupting circuits (GFIC) are applications in which an alternative solution might be more prudent.

Applications

Telecommunications equipment best suited for a fuse is equipment that requires surface mount technology, accurate longitudinal balance, and regulatory compliance without the use of additional series line impedance.

Selection Criteria

For circuits that do not require additional series resistance, the surge current rating (I_{PP}) of the *TeleLink* SM fuse should be greater than or equal to the surge currents associated with the lightning immunity tests of the applicable regulatory requirement (I_{PK}).

$$I_{PP} \geq I_{PK}$$

For circuits that use additional series resistance, the surge current rating (I_{PP}) of the *TeleLink* SM fuse should be greater than or equal to the available surge currents associated with the lightning immunity tests of the applicable regulatory requirement ($I_{PK (available)}$).

$$I_{PP} \geq I_{PK (available)}$$

The maximum available surge current is calculated by dividing the peak surge voltage (V_{PK}) by the total circuit resistance (R_{TOTAL}).

$$I_{PP} \geq I_{PK (available)} = V_{PK}/R_{TOTAL}$$

For longitudinal surges (Tip-Ground, Ring-Ground), R_{TOTAL} is calculated for both Tip and Ring.

$$R_{TOTAL} = R_{TIP} + R_{SOURCE}$$

$$R_{TOTAL} = R_{RING} + R_{SOURCE}$$

For metallic surges (Tip-Ring):

$$R_{TOTAL} = R_{TIP} + R_{RING} + R_{SOURCE}$$

To select the most appropriate combination of *TeleLink* SM fuse and *SIDACtor* device, decide the regulatory requirement your equipment must meet:

Regulatory Requirement	<i>TeleLink</i> SM Fuse	<i>SIDACtor</i> Device
GR 1089	F1250T	C Series
TIA-968, Type A	F1250T	B Series
TIA-968, Type B	F0500T	A Series
ITU K.20	F1250T	A Series
ITU K.21 Basic/Enhanced	F1250T	A Series
UL 60950	All	All

For applications that do not require agency approval or multiple listings, contact the factory.

Power/Line Feed Resistors

Typically manufactured with a ceramic case or substrate, power and line feed resistors have the ability to sink a great deal of energy and are capable of withstanding both lightning and power cross conditions.

Advantages

Power and line feed resistors are available with very tight resistive tolerances, making them appropriate for applications that require precise longitudinal balance.

Restrictions

Because power and line feed resistors are typically very large and are not available in a surface mount configuration, these devices are less than desirable from a manufacturing point of view. Also, because a thermal link is typically not provided, power and line feed resistors may require either a fuse or a PTC to act as the fusing element during a power cross condition.

Applications

Power and line feed resistors are typically found on line cards that use overvoltage protectors that cannot withstand the surge currents associated with applicable regulatory requirements.

Flameproof Resistors

For cost-sensitive designs, small (1/8 W - 1/4 W), flameproof metal film resistors are often used in lieu of PTCs, fuses, and power or line feed resistors. During a transient condition, flameproof resistors open when the resultant energy is great enough to melt the metal used in the device.

Advantages

Flameproof resistors are inexpensive and plentiful.

Restrictions

Flameproof resistors are not resistive to transient conditions and are susceptible to nuisance blows.

Applications

Outside of very inexpensive customer premise equipment, small resistors are rarely used as a means to protect telecommunications equipment during power fault conditions.

EEPW 电子产品世界 .com.cn

PCB Layout

Because the interface portion of a Printed Circuit Board (PCB) is subjected to high voltages and surge currents, consideration should be given to the trace widths, trace separation, and grounding.

Trace Widths

Based on the Institute for Interconnecting and Packaging Electronic Currents, IPC D 275 specifies the trace widths required for various current-carrying capacities. This is very important for grounding conditions to ensure the integrity of the trace during a surge event. The required width is dependent on the amount of copper used for the trace and the acceptable temperature rise which can be tolerated. Teccor recommends a 0.025 inch trace width with 1 ounce copper. (For example, a 38-AWG wire is approximately equal to 8 mils to 10 mils. Therefore, the minimum trace width should be greater than 10 mils.)

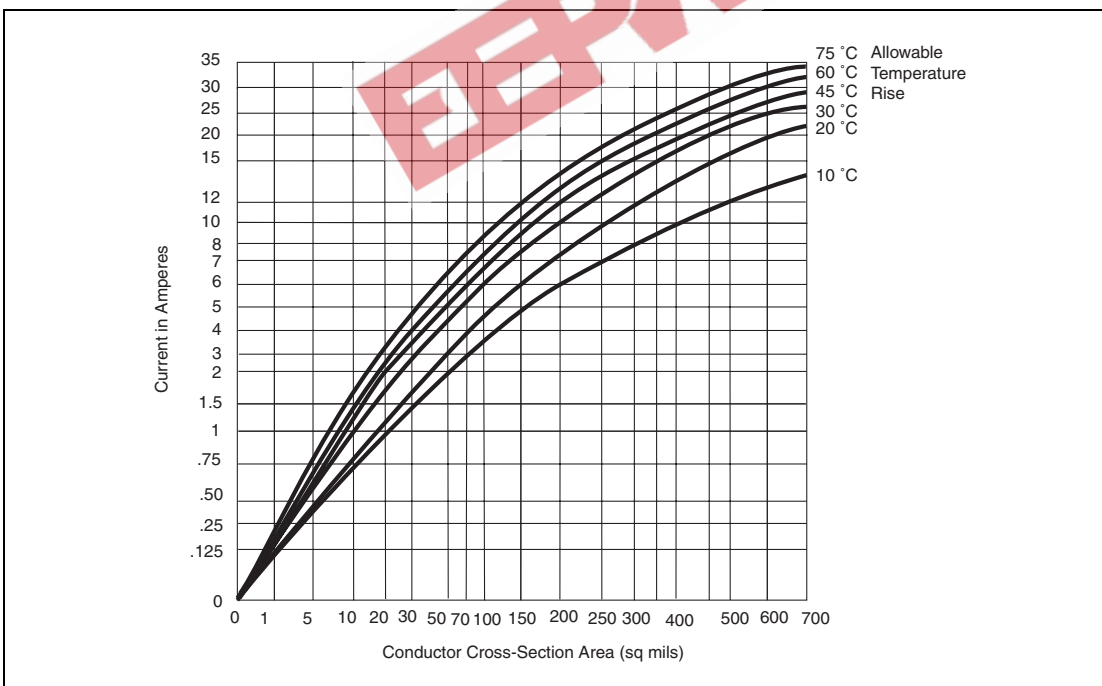

Figure 5.4 Current versus Area

The minimum width and thickness of conductors on a PCB is determined primarily by the current-carrying capacity required. This current-carrying capacity is limited by the allowable temperature rise of the etched copper conductor. An adjacent ground or power layer can significantly reduce this temperature rise. A single ground plane can generally raise the allowed current by 50%. An easy approximation can be generated by starting with the information in Figure 5.4 to calculate the conductor cross-sectional area required. Once this

has been done, Figure 5.5 shows the conversion of the cross-sectional area to the required conductor width, dependent on the copper foil thickness of the trace.

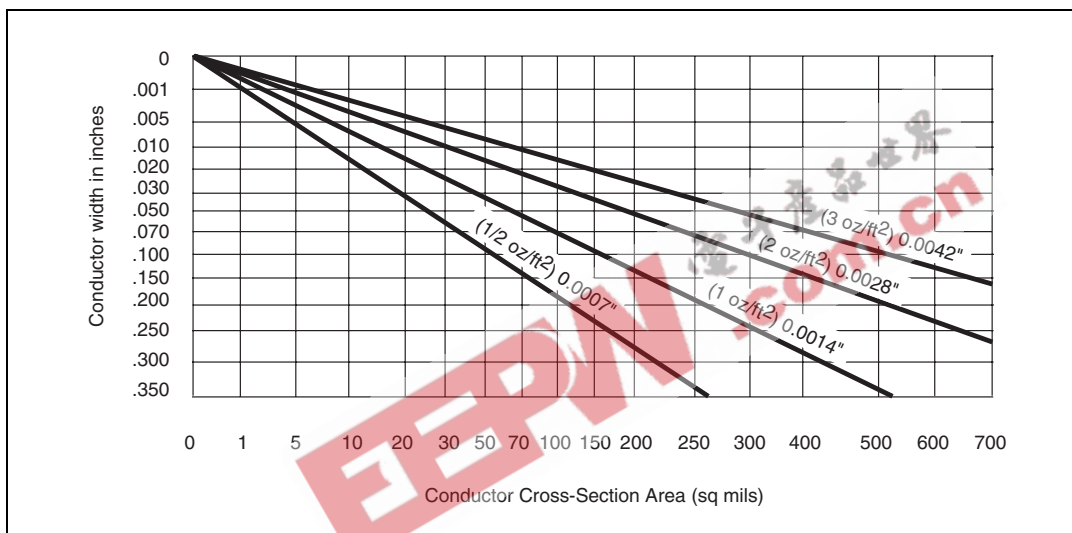

Figure 5.5 Conductor Width versus Area

Trace Separation

Tip and Ring traces are subjected to various transient and overvoltage conditions. To prevent arcing between traces, minimum trace separation should be maintained. UL 60950 will provide additional information regarding creepage and clearance requirements, which are dependent on the Comparative Tracking Index (CTI) rating of the PCB, working voltage, and the expected operating environment. See "UL 60950 3rd Edition (formerly UL 1950, 3rd edition)" on page 4-16 of this data book.

A good rule of thumb for outside layers is to maintain a minimum of 18 mils for 1kV isolation. Route the Tip and Ring traces towards the edge of the PCB away from areas containing static sensitive devices.

Grounding

Although often overlooked, grounding is a very important design consideration when laying out a protection interface circuit. To optimize its effectiveness, several things should be considered in sequence:

1. Provide a large copper plane with a grid pattern for the Ground reference point.
2. Decide if a single-point or a multi-point grounding scheme is to be used. A single-point (also called centralized) grounding scheme is used for circuit dimensions smaller than one-tenth of a wavelength ($\lambda = 300,000/\text{frequency}$) and a multi-point (distributed) grounding scheme is used for circuit trace lengths greater than one-fourth of a wavelength.

3. Because traces exhibit a certain level of inductance, keep the length of the ground trace on the PCB as short as possible in order to minimize its voltage contribution during a transient condition. In order to determine the actual voltage contributed to trace inductance, use the following equations:

$$V = L (di/dt)$$

$$L = 0.0051 \rho [\log_e 2 \rho / (t+w) + \frac{1}{2} - \log_e G] \text{ in } \mu\text{H}$$

where ρ = length of trace
 G = function of thickness and width as provided in Table 5.3
 t = trace thickness
 w = trace width

For example, assume circuit A is protected by a P3100SC with a V_s equal to 300 V and a ground trace one inch in length and a self-inductance equal to 2.4 $\mu\text{H}/\text{inch}$. Assume circuit B has the identical characteristics as Circuit A, except the ground trace is five inches in length instead of one inch in length. If both circuits are surged with a 100 A, 10x1000 μs wave-form, the results would be as shown in Table 5.2:

Table 5.2 Overshoot Caused by Trace Inductance

	$V_L = L (di/dt)$	SIDACTor device V_s	Total protection level ($V_L + V_s$)
Circuit A	$V_L = 2.4 \mu\text{H} (100 \text{ A}/10 \mu\text{s}) = 24 \text{ V}$	300 V	324 V
Circuit B	$V_L = 12 \mu\text{H} (100 \text{ A}/10 \mu\text{s}) = 120 \text{ V}$	300 V	420 V

Other practices to ensure sound grounding techniques are:

1. Cross signal grounds and earth grounds perpendicularly in order to minimize the field effects of "noisy" power supplies.
2. Make sure that the ground fingers on any edge connector extend farther out than any power or signal leads in order to guarantee that the ground connection invariably is connected first.

Table 5.3 Values of Constants for the Geometric Mean Distance of a Rectangle

t/w or w/t	K	Log _e G
0.000	0.22313	0.0
0.025	0.22333	0.00089
0.050	0.22346	0.00146
0.100	0.22360	0.00210
0.150	0.22366	0.00239
0.200	0.22369	0.00249
0.250	0.22369	0.00249
0.300	0.22368	0.00244
0.350	0.22366	0.00236
0.400	0.22364	0.00228
0.450	0.22362	0.00219
0.500	0.22360	0.00211
0.500	0.22360	0.00211
0.550	0.22358	0.00203
0.600	0.22357	0.00197
0.650	0.22356	0.00192
0.700	0.22355	0.00187
0.750	0.22354	0.00184
0.800	0.22353	0.00181
0.850	0.22353	0.00179
0.900	0.22353	0.00178
0.950	0.223525	0.00177
1.000	0.223525	0.00177
0.000	0.0	0.0

Note: Sides of the rectangle are t and w. The geometric mean distance R is given by:
 $\log_e R = \log_e(t+w) - 1.5 + \log_e G$, $R = K(t+w)$, $\log_e K = -1.5 + \log_e G$.

SIDACtor Soldering Recommendations

When placing surface mount components, a good solder bond is critical because:

- The solder provides a thermal path in which heat is dissipated from the packaged silicon to the rest of the board.
- A good bond is less subject to thermal fatiguing and results in improved component reliability.

Reflow Soldering

The preferred technique for mounting the DO-214AA package is to reflow-solder the device onto a PCB-printed circuit board, as shown in Figure 5.6.

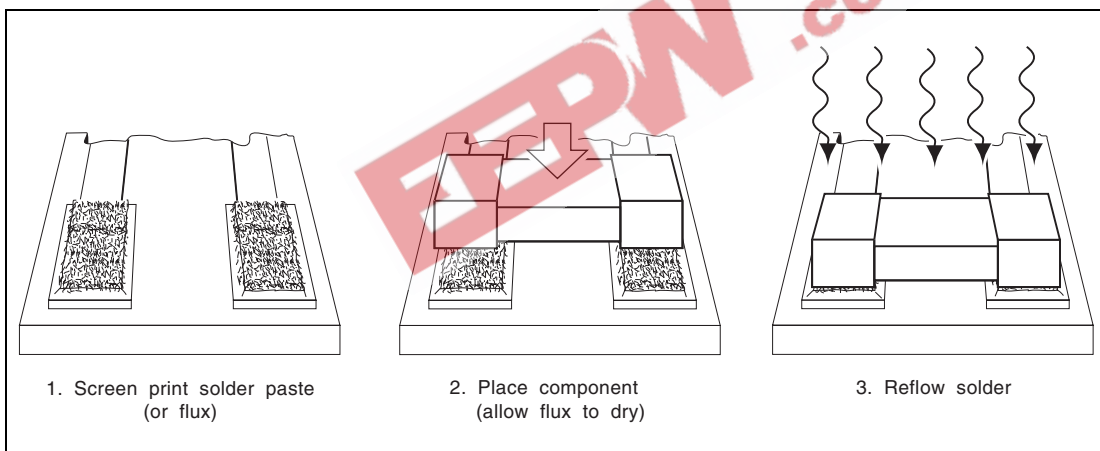

Figure 5.6 Reflow Soldering Procedure

For reliable connections, the PCB should first be screen printed with a solder paste or fluxed with an easily removable, reliable solution, such as Alpha 5003 diluted with benzyl alcohol. If using a flux, the PCB should be allowed to dry to touch at room temperature (or in a 70 °C oven) prior to placing the components on the solder pads.

Relying on the adhesive nature of the solder paste or flux to prevent the devices from moving prior to reflow, components should be placed with either a vacuum pencil or automated pick and place machine.

With the components in place, the PCB should be heated to a point where the solder on the pads begins to flow. This is typically done on a conveyor belt which first transports the PCB through a pre-heating zone. The pre-heating zone is necessary in order to reduce thermal shock and prevent damage to the devices being soldered, and should be limited to a maximum temperature of 165 °C for 10 seconds.

After pre-heating, the PCB goes to a vapor zone, as shown in Figure 5.7. The vapor zone is obtained by heating an inactive fluid to its boiling point while using a vapor lock to regulate the chamber temperature. This temperature is typically 215 °C, but for temperatures in excess of 215 °C, care should be taken so that the maximum temperature of the leads does

not exceed 275 °C and the maximum temperature of the plastic body does not exceed 250 °C. (Figure 5.8)

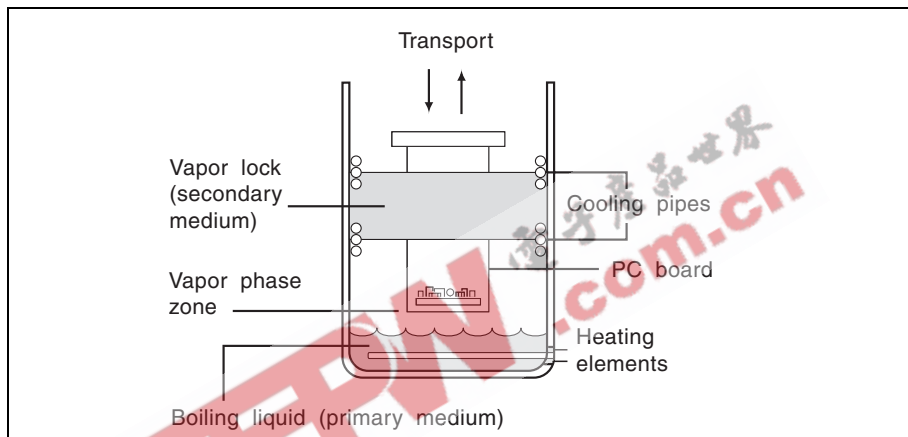

Figure 5.7 Principle of Vapor Phase Soldering

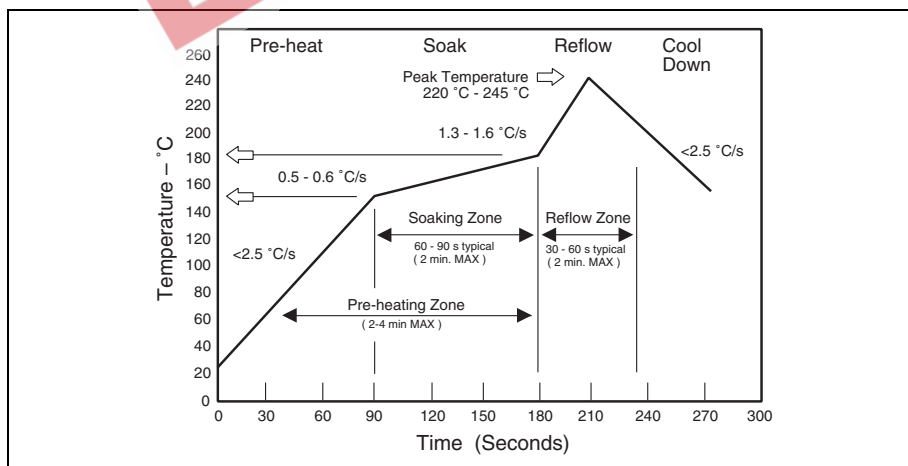

Figure 5.8 Reflow Soldering Profile

During reflow, the surface tension of the liquid solder draws the leads of the device towards the center of the soldering area, correcting any misalignment that may have occurred during placement and allowing the device to set flush on the pad. If the footprints of the pad are not concentrically aligned, the same effect can result in undesirable shifts as well. Therefore, it is important to use a standard contact pattern which leaves sufficient room for self-positioning.

After the solder cools, connections should be visually inspected and remnants of the flux removed using a vapor degreaser with an azeotrope solvent or equivalent.

Wave Soldering

Another common method for soldering components to a PCB is wave soldering. After fluxing the PCB, an adhesive is applied to the respective footprints so that components can be glued in place. Once the adhesive has cured, the board is pre-heated and then placed in contact with a molten wave of solder which has a temperature between 240 °C and 260 °C and permanently affixes the component to the PCB. (Figure 5.8 and Figure 5.10)

Although a popular method of soldering, wave soldering does have drawbacks:

- A double pass is often required to remove excess solder.
- Solder bridging and shadows begin to occur as board density increases.
- Wave soldering uses the sharpest thermal gradient.

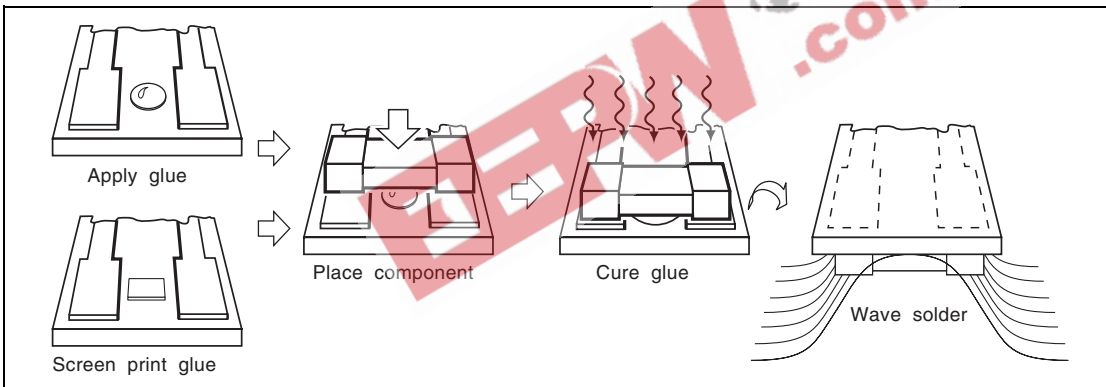

Figure 5.9 Wave Soldering Surface Mount Components Only

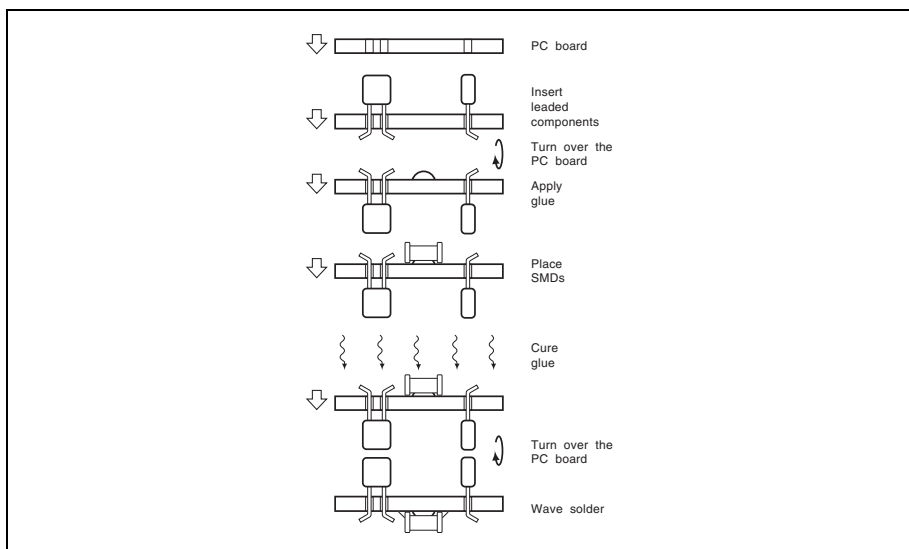

Figure 5.10 Wave Soldering Surface Mount and Leaded Components

TeleLink Fuse Soldering

For wave soldering a *TeleLink* fuse, the following temperature and time are recommended:

- Reservoir temperature of 260 °C (500 °F)
- Time in reservoir — three seconds maximum

For infrared, the following temperature and time are recommended:

- Temperature of 240 °C (464 °F)
- Time — 30 seconds maximum

Hand soldering is not recommended for this fuse because excessive heat can affect the fuse performance. Hand soldering should be used only for rework and low volume samples.

Note the following recommendations for hand soldering:

- Maximum tip temperature of 240 °C (464 °F)
- Minimize the soldering time at temperature to achieve the solder joint. Measure the fuse resistance before and after soldering. Any fuse that shifts more than $\pm 3\%$ should be replaced. An increase in resistance above this amount increases the possibility of a surge failure, and a decrease in resistance may cause low overloads to exceed the maximum opening times.
- Inspect the solder joint to ensure an adequate solder fillet has been produced without any cracks or visible defects.

Telecommunications Protection

Because early telecommunications equipment was constructed with components such as mechanical relays, coils, and vacuum tubes, it was somewhat immune to lightning and power cross conditions. But as cross bar and step-by-step switches have given way to more modern equipment such as digital loop carriers, repeater amplifiers, and multiplexers, an emphasis has been put on protecting this equipment against system transients caused by lightning and power cross conditions.

Lightning

During an electrical storm, transient voltages are induced onto the telecommunications system by lightning currents which enter the conductive shield of suspended cable or through buried cables via ground currents.

As this occurs, the current traveling through the conductive shield of the cable produces an equal voltage on both the Tip and Ring conductors at the terminating ends. Known as a longitudinal voltage surge, the peak value and wave-form associated with this condition is dependent upon the distance the transient travels down the cable and the materials with which the cable is constructed.

Although lightning-induced surges are always longitudinal in nature, imbalances resulting from terminating equipment and asymmetric operation of primary protectors can result in metallic transients as well. A Tip-to-Ring surge is normally seen in terminating equipment and is the primary reason most regulatory agencies require telecom equipment to have both longitudinal and metallic surge protection.

Power Cross

Another system transient that is a common occurrence for telecommunications cables is exposure to the AC power system. The common use of poles, trenches, and ground wires results in varying levels of exposure which can be categorized as direct power cross, power induction, and ground potential rise.

Direct power cross occurs when a power line makes direct contact to telecommunications cables. Direct contact is commonly caused by falling trees, winter icing, severe thunderstorms, and vehicle accidents. Direct power cross can result in large currents being present on the line.

Power induction is common where power cables and telecommunications cables are run in close proximity to one another. Electromagnetic coupling between the cables results in system transients being induced onto the telecommunications cables, which in turn can cause excessive heating and fires in terminal equipment located at the cable ends.

Ground potential rise is a result of large fault currents flowing to Ground. Due to the varying soil resistivity and multiple grounding points, system potential differences may result.

Lightning

Lightning is one of nature's most common and dangerous phenomena. At any one time, approximately 2,000 thunderstorms are in progress around the globe, with lightning striking the earth over 100 times per second. According to IEEE C.62, during a single year in the United States lightning strikes an average of 52 times per square mile, resulting in 100 deaths, 250 injuries, and over 100 million dollars in damage to equipment property.

The Lightning Phenomenon

Lightning is caused by the complex interaction of rain, ice, up drafts, and down drafts that occur during a typical thunderstorm. The movement of rain droplets and ice within the cloud results in a large build up of electrical charges at the top and bottom of the thunder cloud. Normally, positive charges are concentrated at the top of the thunderhead while negative charges accumulate near the bottom. Lightning itself does not occur until the potential difference between two charges is great enough to overcome the insulating resistance of air between them.

Formation of Lightning

Cloud-to-ground lightning begins forming as the level of negative charge contained in the lower cloud levels begins to increase and attract the positive charge located at Ground. When the formation of negative charge reaches its peak level, a surge of electrons called a stepped leader begins to head towards the earth. Moving in 50-meter increments, the stepped leader initiates the electrical path (channel) for the lightning strike. As the stepped leader moves closer to the ground, the mutual attraction between positive and negative charges results in a positive stream of electrons being pulled up from the ground to the stepped leader. The positively charged stream is known as a streamer. When the streamer and stepped leader make contact, it completes the electrical circuit between the cloud and ground. At that instant, an explosive flow of electrons travels to ground at half the speed of light and completes the formation of the lightning bolt.

Lightning Bolt

The initial flash of a lightning bolt results when the stepped leader and the streamer make connection resulting in the conduction of current to Ground. Subsequent strokes (3-4) occur as large amounts of negative charge move farther up the stepped leader. Known as return strokes, these subsequent bolts heat the air to temperatures in excess of 50,000 °F and cause the flickering flash that is associated with lightning. The total duration of most lightning bolts lasts between 500 ms and one second.

During a lightning strike, the associated voltages range from 20,000 V to 1,000,000 V while currents average around 35,000 A. However, maximum currents associated with lightning have been measured as high as 300,000 A.

NOTES

EEPW 电子产品世界
.com.cn

6 *Mechanical Data*

The following section describes the mechanical specifications of SIDACtor products.

Package Dimensions	6-3
DO-214AA	6-3
Modified DO-214AA	6-4
TO-92	6-5
MS-013	6-6
Modified TO-220	6-7
TO-218	6-8
TeleLink Surface Mount Fuse	6-9
Single In-line Protector (SIP)	6-10
Summary of Packing Options	6-12
Packing Options	6-14
DO-214AA	6-14
TO-92	6-15
Modified MS-013 Six-pin	6-16
Modified TO-220	6-17
TeleLink Surface Mount Fuse	6-18
Lead Form Options	6-20
Modified TO-220 Type 60	6-20
Modified TO-220 Type 61	6-21
Modified TO-220 Type 62	6-21

EEPW 电子产品世界
 .com.cn

Package Dimensions

DO-214AA

The DO-214AA package is designed to meet mechanical standards as set forth in JEDEC publication number 95.

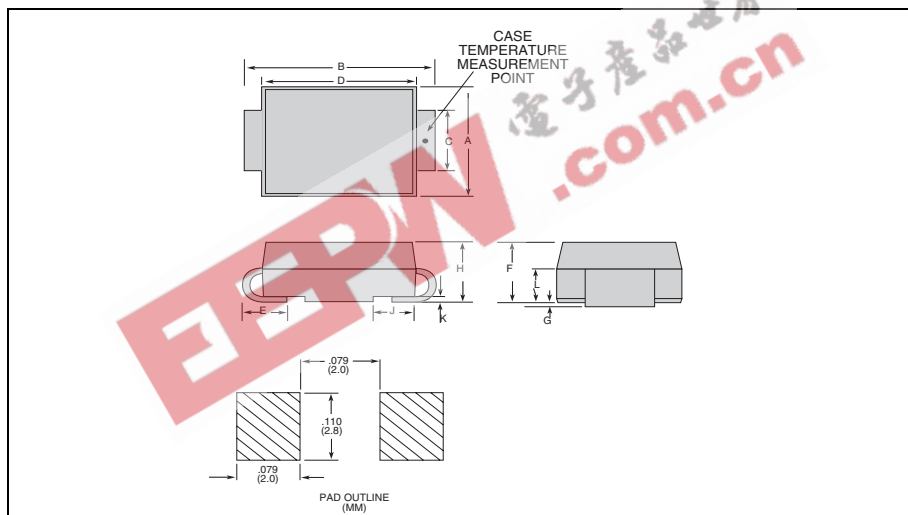

Note: A stripe is marked on some parts, to indicate the cathode. IPC-SM-782 recommends 2.4 instead of 2.0.

Dimension	Inches		Millimeters	
	MIN	MAX	MIN	MAX
A	0.140	0.155	3.56	3.94
B	0.205	0.220	5.21	5.59
C	0.077	0.083	1.96	2.11
D	0.166	0.180	4.22	4.57
E	0.036	0.056	0.91	1.42
F	0.073	0.083	1.85	2.11
G	0.004	0.008	0.10	0.20
H	0.077	0.086	1.95	2.18
J	0.043	0.053	1.09	1.35
K	0.008	0.012	0.20	0.30
L	0.039	0.049	0.99	1.24

Notes:

- Dimensions and tolerances per ASME Y14.5M-1994
- Mold flash shall not exceed 0.13 mm per side.
- Dimensions B and C apply to plated leads.
- All leads are insulated from case. Case is electrically non-conductive. (Rated at 1600 V ac rms for one minute from leads to case over the operating temperature range)
- Dimension "C" is measured on the flat section of the lead.

Modified DO-214AA

The Modified DO-214AA package is a three-leaded surface mount (SM) package.

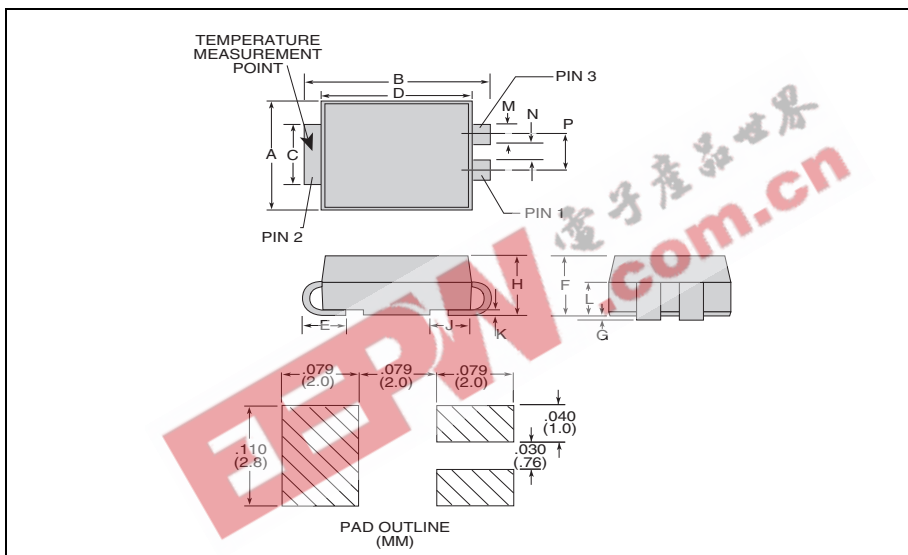

Note: A stripe is marked on some parts, to indicate the cathode. IPC-SM-782 recommends 2.4 instead of 2.0.

Dimension	Inches		Millimeters	
	MIN	MAX	MIN	MAX
A	0.140	0.155	3.56	3.94
B	0.205	0.220	5.21	5.59
C	0.077	0.083	1.96	2.11
D	0.166	0.180	4.22	4.57
E	0.036	0.056	0.91	1.42
F	0.073	0.083	1.85	2.11
G	0.004	0.008	0.10	0.20
H	0.077	0.086	1.95	2.18
J	0.043	0.053	1.09	1.35
K	0.008	0.012	0.20	0.30
L	0.039	0.049	0.99	1.24
M	0.022	0.028	0.56	0.71
N	0.027	0.033	0.69	0.84
P	0.052	0.058	1.32	1.47

Notes:

- Dimensions and tolerancing per ASME Y14.5M-1994
- Mold flash shall not exceed 0.13 mm per side.
- Dimensions B and C apply to plated leads.
- All leads are insulated from case. Case is electrically non-conductive. (Rated at 1600 V ac rms for one minute from leads to case over the operating temperature range)

TO-92

The TO-92 is designed to meet mechanical standards as set forth in JEDEC publication number 95.

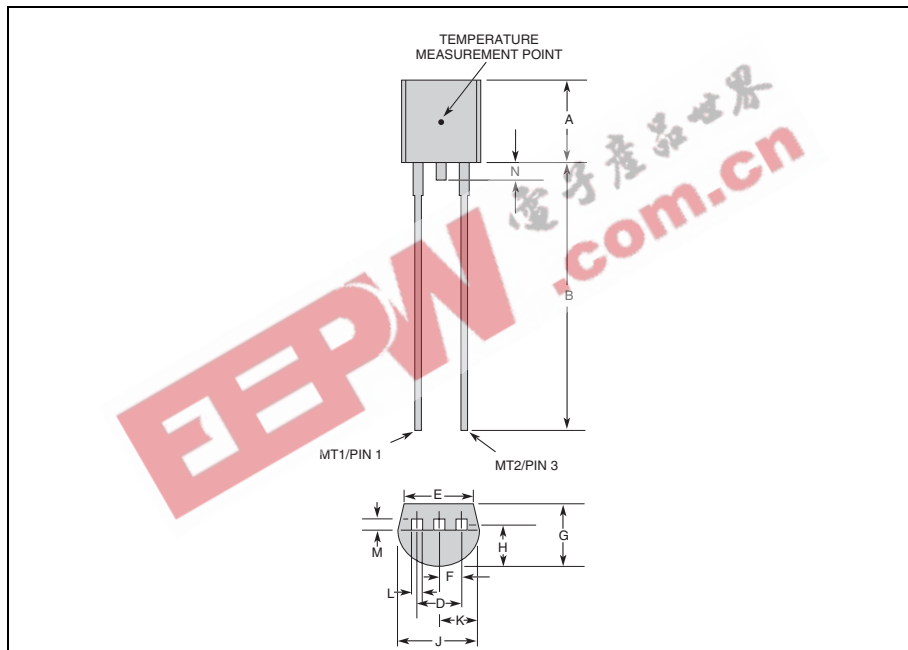

Dimension	Inches		Millimeters	
	MIN	MAX	MIN	MAX
A	0.176	0.196	4.47	4.98
B	0.500		12.70	
D	0.095	0.105	2.41	2.67
E	0.150		3.81	
F	0.046	0.054	1.16	1.37
G	0.135	0.145	3.43	3.68
H	0.088	0.096	2.23	2.44
J	0.176	0.186	4.47	4.73
K	0.088	0.096	2.23	2.44
L	0.013	0.019	0.33	0.48
M	0.013	0.017	0.33	0.43
N		0.060		1.52

Notes:

- Type 70 lead form as shown is standard for the E package.
- All leads are insulated from case. Case is electrically non-conductive. (Rated at 1600 V ac rms for one minute from leads to case over the operating temperature range)
- Mold flash shall not exceed 0.13 mm per side.

Mechanical Data

MS-013

The MS-013 is designed to meet mechanical standards as set forth in JEDEC publication number 95.

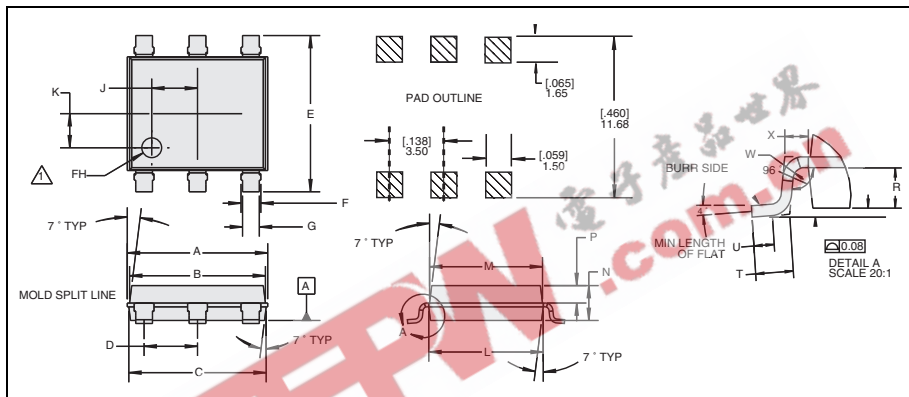

Dimension	Inches		Millimeters	
	MIN	MAX	MIN	MAX
A	0.360	0.364	9.14	9.25
B	0.348	0.352	8.84	8.94
C	0.352	0.356	8.94	9.04
D	0.138	0.138	3.51	3.51
E	0.400	0.412	10.16	10.46
F		0.051		1.30
G		0.043		1.09
H		0.051		1.30
J		0.118		3.00
K		0.089		2.26
L	0.293	0.293	0.30	7.44
M	0.289	0.293	7.34	7.44
N	0.089	0.093	2.26	2.36
P	0.045	0.045	1.14	1.14
R	0.034	0.036	0.86	0.91
S	0.008	0.008	0.20	0.20
T	0.036	0.036	0.91	0.91
U	0.020		0.51	
W	0.010	0.010	0.25	0.25
X	0.023	0.023	0.58	0.58

Notes:

- Dimensions and tolerances per ASME Y14.5M-1982
- Mold flash shall not exceed 0.13 mm per side.
- All leads are insulated from case. Case is electrically non-conductive. (Rated at 1600 V ac rms for one minute from leads to case over the operating temperature range)

Modified TO-220

The Modified TO-220 package is designed to meet mechanical standards as set forth in JEDEC publication number 95.

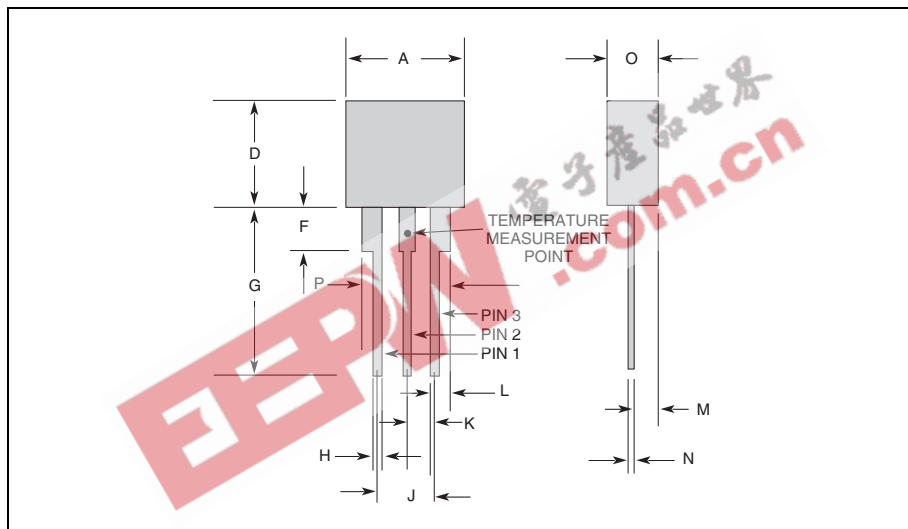

Dimension	Inches		Millimeters	
	MIN	MAX	MIN	MAX
A	0.400	0.410	10.16	10.42
D	0.360	0.375	9.14	9.53
F	0.110	0.130	2.80	3.30
G	0.540	0.575	13.71	14.61
H	0.025	0.035	0.63	0.89
J	0.195	0.205	4.95	5.21
K	0.095	0.105	2.41	2.67
L	0.075	0.085	1.90	2.16
M	0.070	0.085	1.78	2.16
N	0.018	0.024	0.46	0.61
O	0.178	0.188	4.52	4.78
P	0.290	0.310	7.37	7.87

Notes:

- All leads are insulated from case. Case is electrically non-conductive. (Rated at 1600 V ac rms for one minute from leads to case over the operating temperature range)
- Mold flash shall not exceed 0.13 mm per side.

TO-218

The TO-218 package is designed to meet mechanical standards as set forth in JEDEC publication number 95.

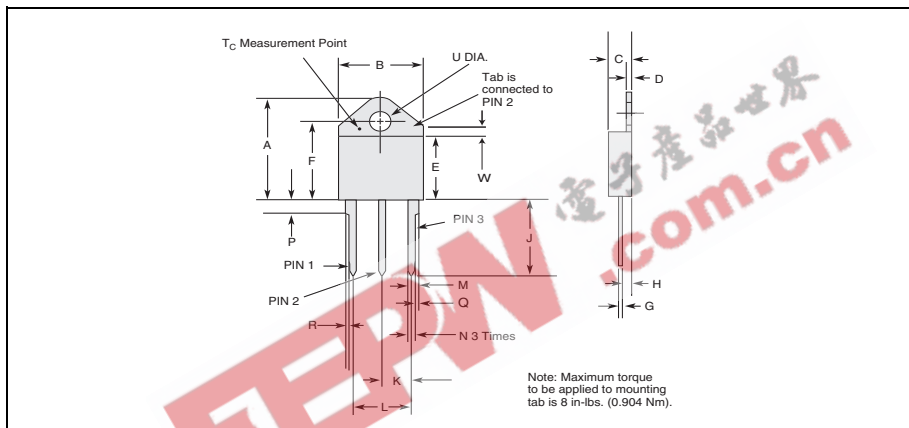

Dimension	Inches		Millimeters	
	MIN	MAX	MIN	MAX
A	0.810	0.835	20.57	21.21
B	0.610	0.630	15.49	16.00
C	0.178	0.188	4.52	4.78
D	0.055	0.070	1.40	1.78
E	0.487	0.497	12.37	12.62
F	0.635	0.655	16.13	16.64
G	0.022	0.029	0.56	0.74
H	0.075	0.095	1.91	2.41
J	0.575	0.625	14.61	15.88
K	0.211	0.219	5.36	5.56
L	0.422	0.437	10.72	11.10
M	0.100	0.110	2.54	2.79
N	0.045	0.055	1.14	1.40
P	0.095	0.115	2.41	2.92
R	0.008	0.016	0.20	0.41
S	0.038	0.048	0.97	1.22
T	0.025	0.032	0.64	0.81
U	0.159	0.163	4.04	4.14
V	0.090	0.100	2.29	2.54

- Notes:
- Mold flash shall not exceed 0.13 mm per side.
 - Maximum torque to be applied to mounting tab is 8 in.-lbs. (0.904 Nm).
 - Pin 3 has no connection.
 - Tab is non-isolated (connects to middle pin).

TeleLink Surface Mount Fuse

The following illustration shows the end view dimensions of a *TeleLink* fuse:

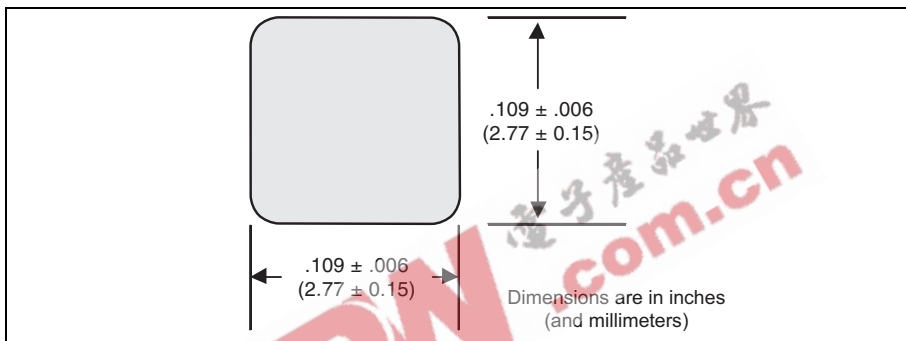

The following illustration shows the top view or side view dimensions of a *TeleLink* fuse:

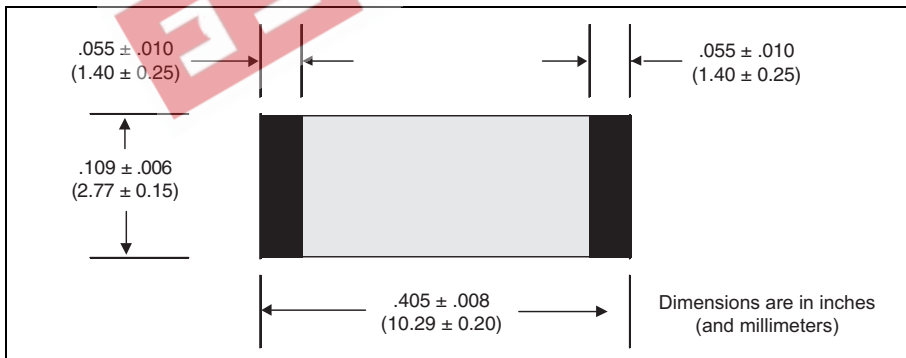

The following illustration shows the footprint dimensions of a *TeleLink* fuse:

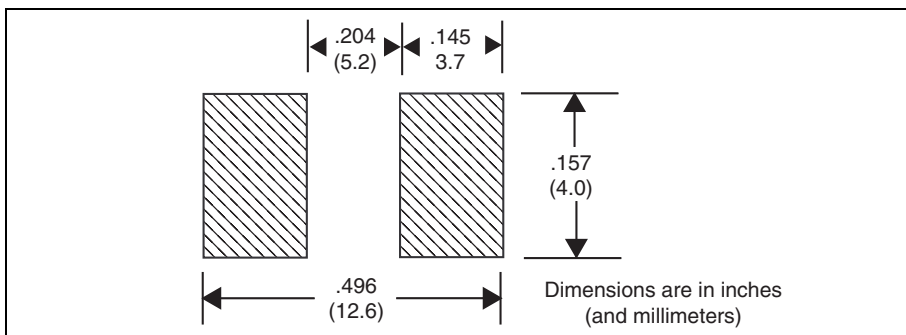

Single In-line Protector (SIP)

The following illustration shows a balanced three-chip SIP protector:

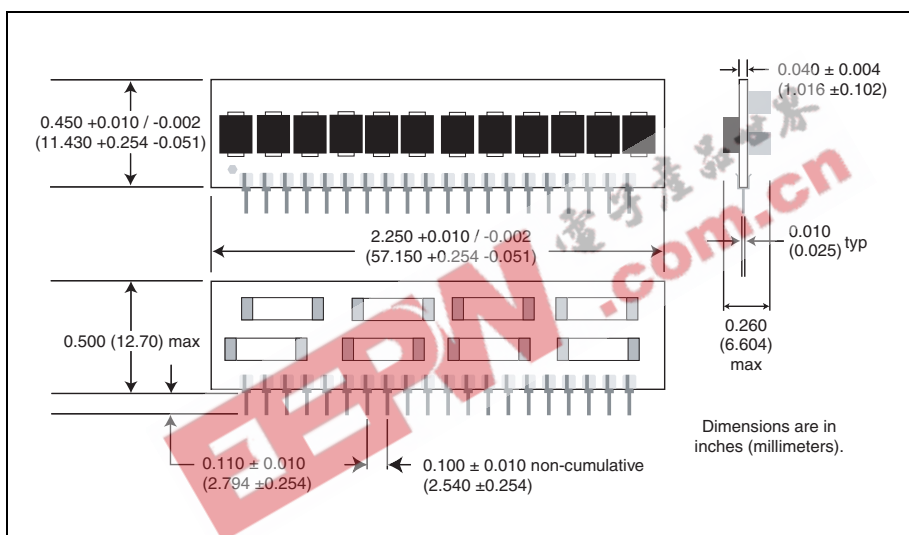

The following illustration shows a longitudinal two-chip SIP protector:

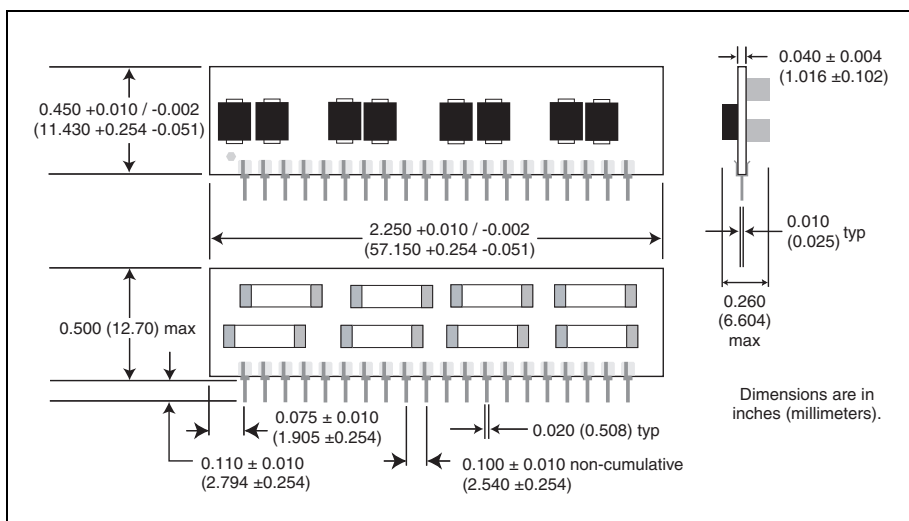

The following illustration shows a four-port metallic line SIP protector:

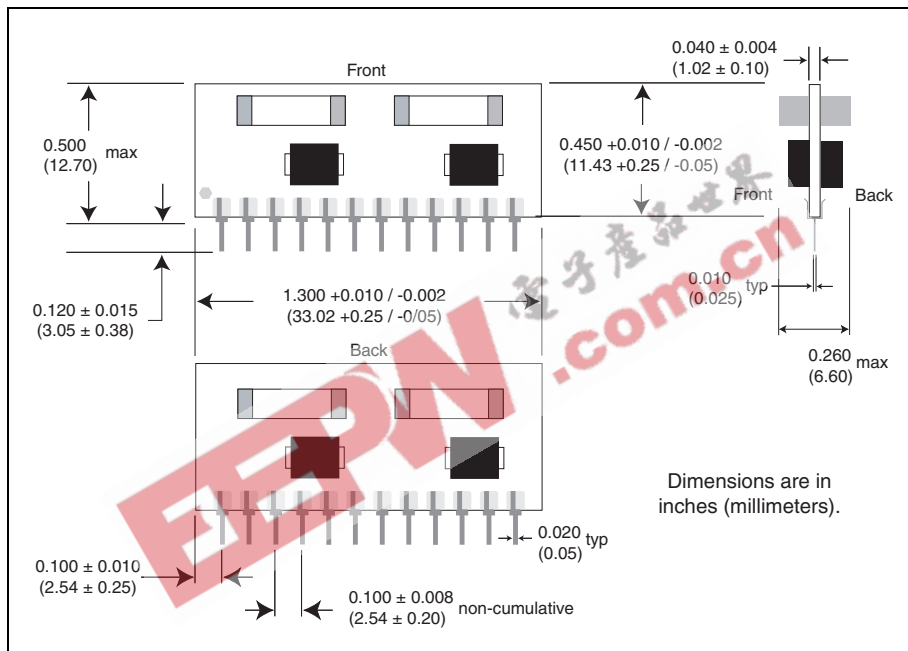

Summary of Packing Options

Package Type	Description	Packing Quantity	Added Suffix	Industry Standard
DO-214AA SA, SB, SC, SD, including MC  3-lead	Embossed Carrier Reel Pack	2500	RP	EIA-481-1
	Bulk Pack	1000	BP	N/A
TO-92 EA, EB, EC, including MC  Note: Standard lead spacing for TO-92 reel pack is 0.200".	Bulk Pack	2000		N/A
	Tape and Reel Pack	2000	RP1, RP2	EIA-468-B
	Ammo Pack	2000	AP	EIA-468-B
Modified MS-013 	Tape and Reel Pack	1500	RP	EIA-481-1
	Bulk Pack	500	BP	
	Tube Pack	50 per tube, 50 tubes per container	TP	EIA-481-1
TO-220 AA, AB, AC, AD  Type 61	Bulk Pack	500		N/A
	Tape and Reel Pack	700	RP	EIA-468-B
	Tape and Reel Pack for Type 61 lead form	700	RP	EIA-468-B
	Tube Pack	50 per tube, 10 tubes per container	TP	EIA-468-B
TO-218 ME 	Bulk Pack	250		N/A

Summary of Packing Options

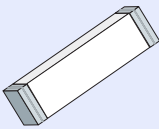
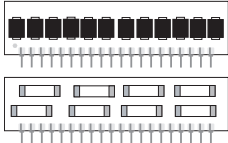
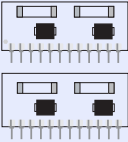
Package Type	Description	Packing Quantity	Added Suffix	Industry Standard
TeleLink Surface Mount Fuse 	Embossed Carrier Reel Pack	2500	RP	EIA-481-B
	Bulk Pack	5000	BP	N/A
Balanced Longitudinal SIP 	Plastic trays	150/tray	None	None
Metallic SIP 	Plastic trays	300/tray	None	None

Packing Options

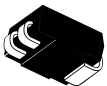
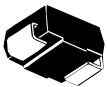

3-lead

DO-214AA

Tape and reel packing options meet all specifications as set forth in EIA-481-1. Standard reel pack quantity is 2500. Bulk pack quantity is 500.

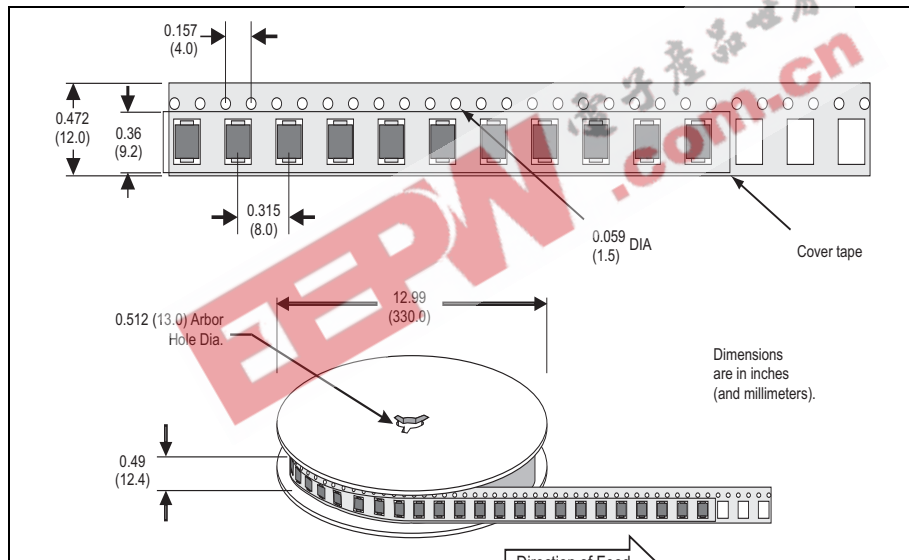

The following illustration shows the DO-214AA component orientation for P0641S, P0721S, P0901S, and P1101S:

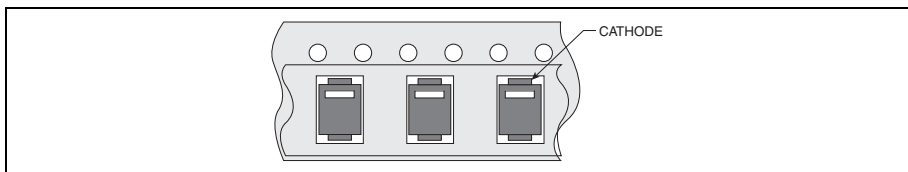

The following illustration shows the modified DO-214 tape and reel:

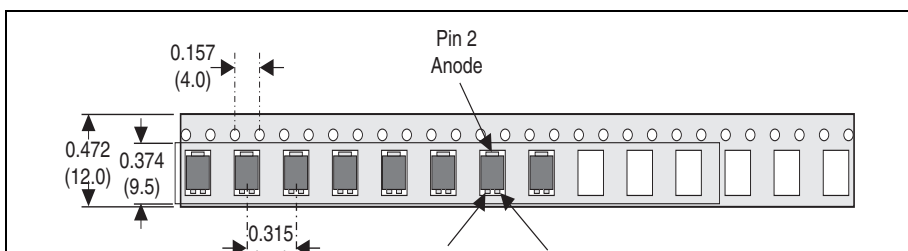



TO-92

Tape and reel packing options meet all specifications as set forth in EIA-468-B. Standard reel pack quantity is 2000.

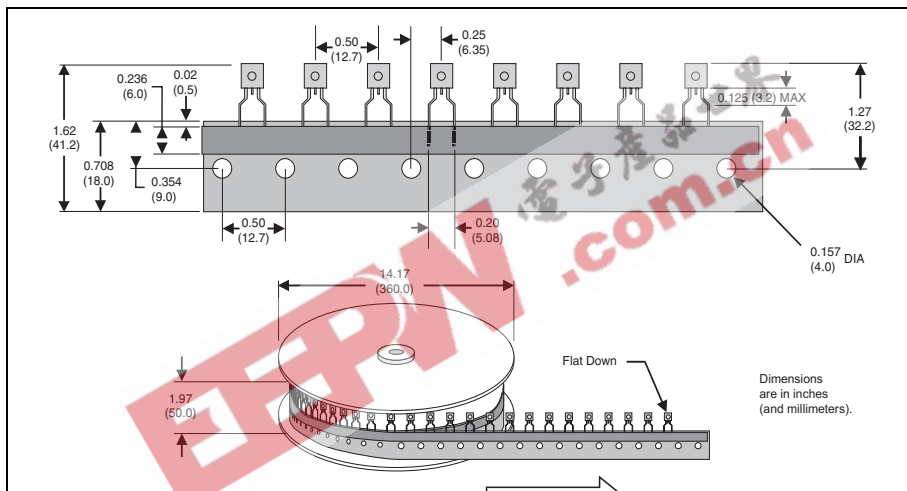

Notes:

- Part number suffix RP2 denotes 0.200" (5 mm) lead spacing and is Teccor's default value.
- Part number suffix RP1 denotes 0.100" (2.54 mm) lead spacing and is available upon request.

The following figure shows the TO-92 Ammo Pack option:

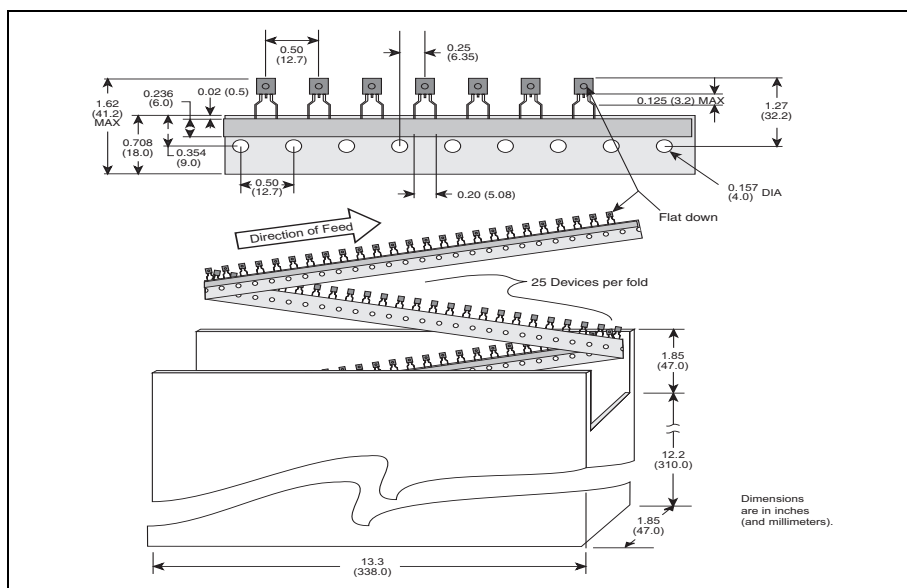

Mechanical Data

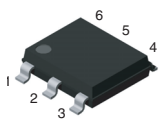

Modified MS-013 Six-pin

Tape and reel packing options meet all specifications as set forth in EIA-468-B. Standard reel pack quantity is 1500.

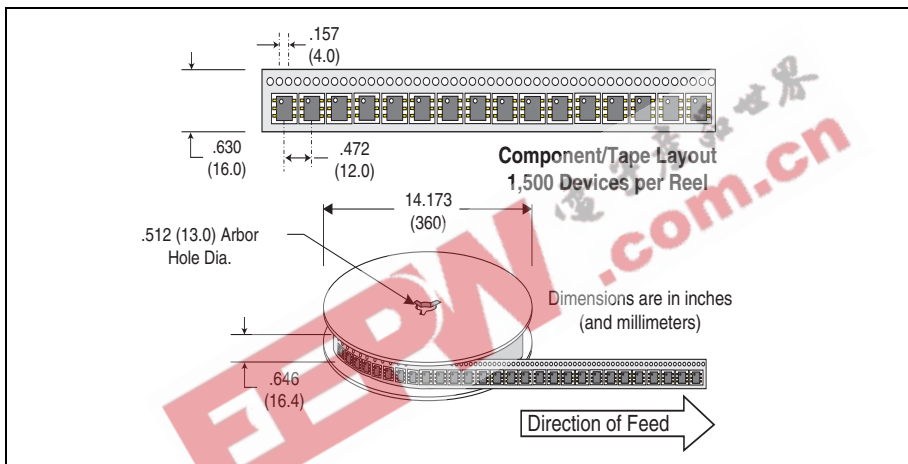

The following illustration shows the tube pack:

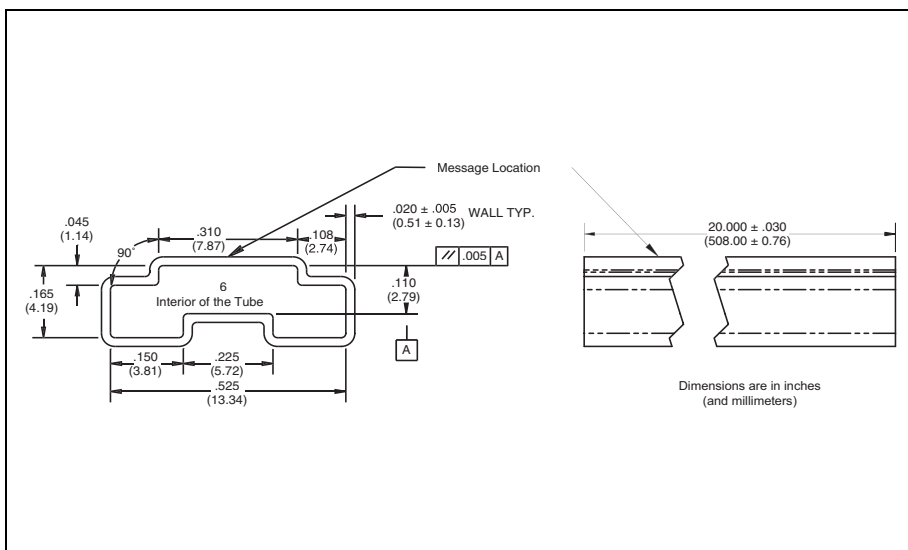

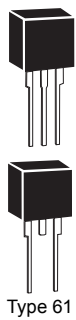

Type 61

Modified TO-220

Tape and reel packing options meet all specifications as set forth in EIA-468-B. Standard reel pack quantity is 700.

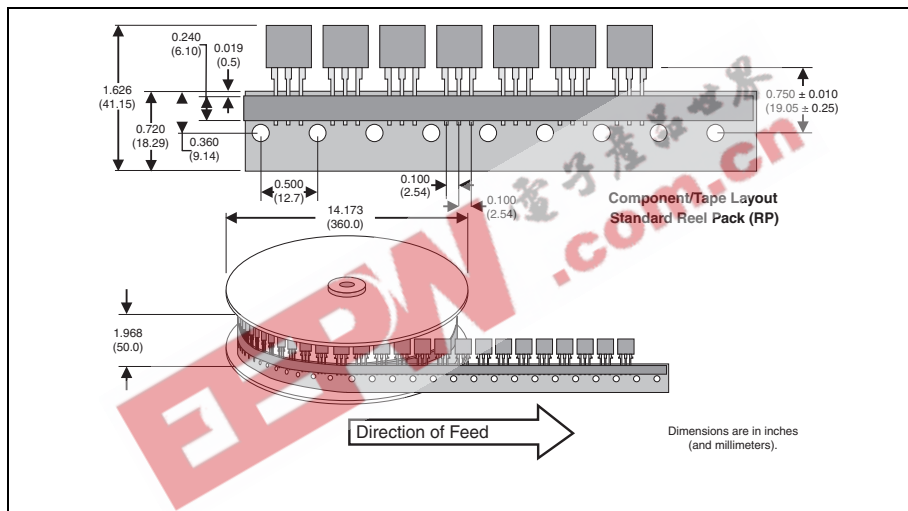

The following illustration shows the tube pack:

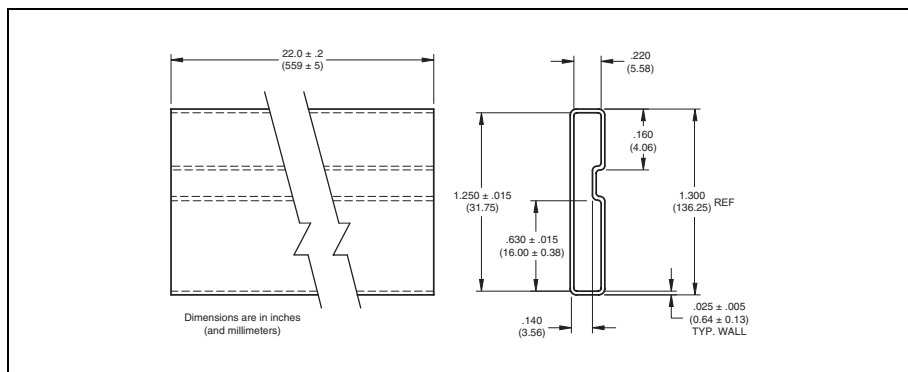

TeleLink Surface Mount Fuse

The following illustration shows the *TeleLink* embossed carrier tape:

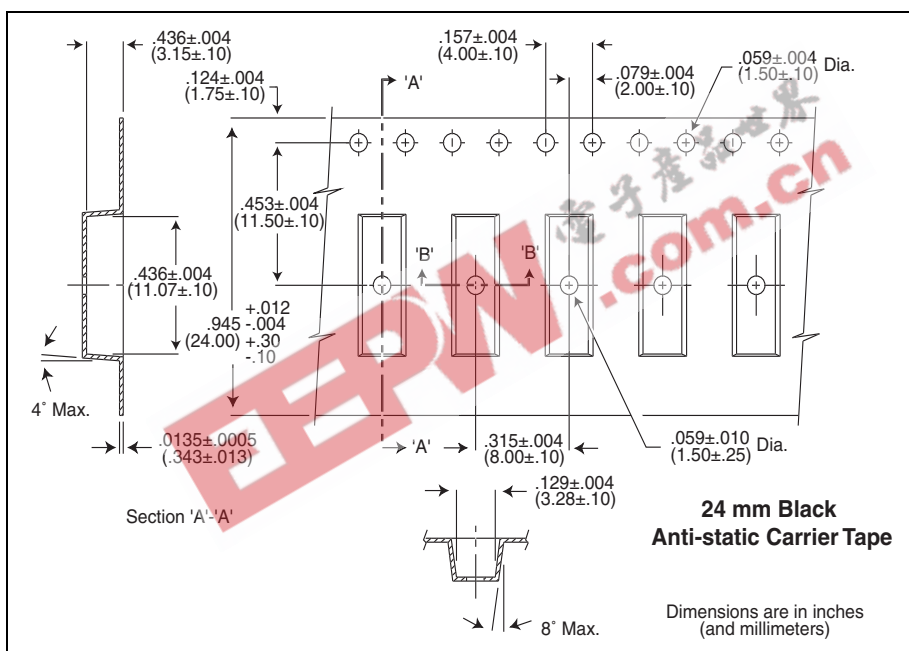

The following illustration shows the *TeleLink* 13-inch (330 mm), injection-molded, high-impact, anti-static, white, plastic reel. Material conforms to EIA-481-1. Surface resistivity is 1011 Ω /square. Materials comply with ASTM D-257.

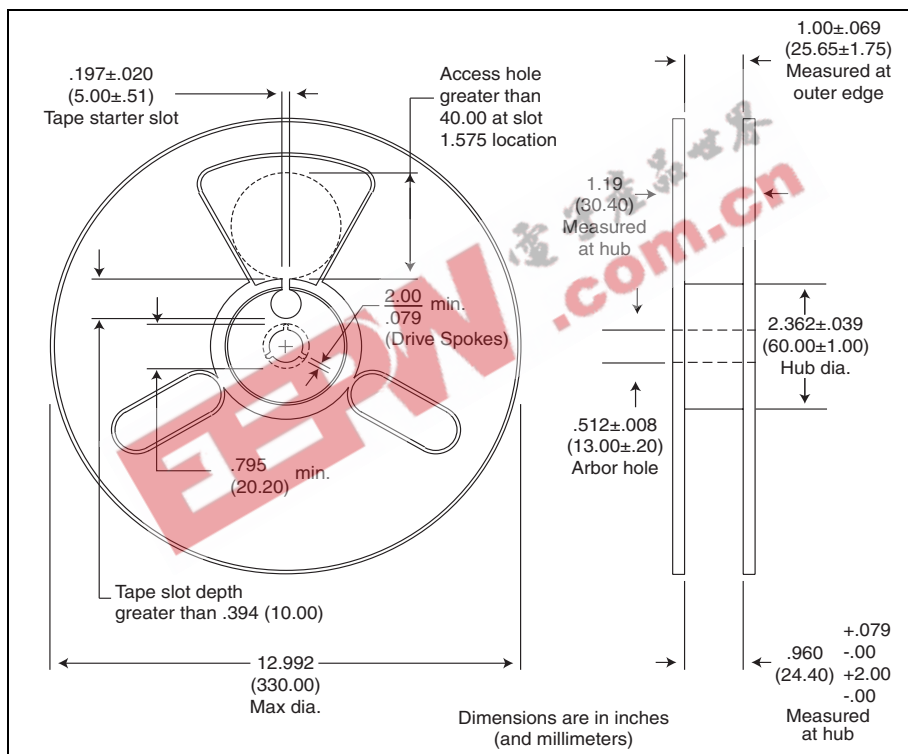

Lead Form Options

Modified TO-220 Type 60

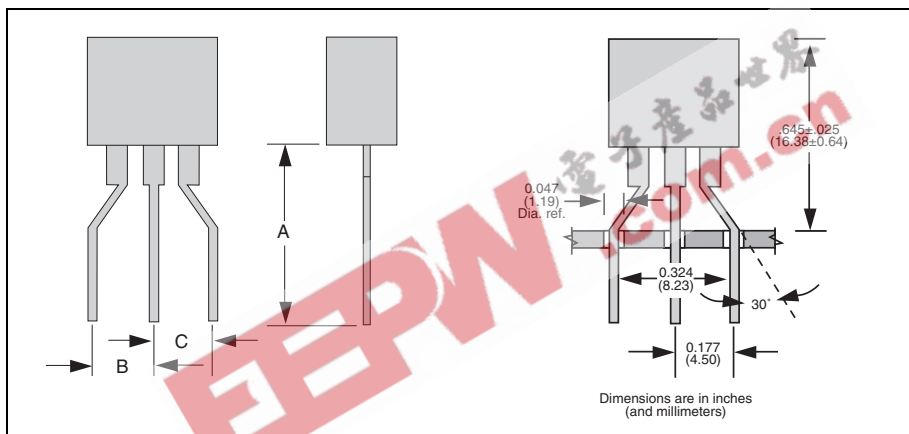

Dimension	Inches		Millimeters	
	Min	Max	Min	Max
A	0.485		12.32	
B	0.162	0.192	4.11	4.88
C	0.162	0.192	4.11	4.88

Modified TO-220 Type 61

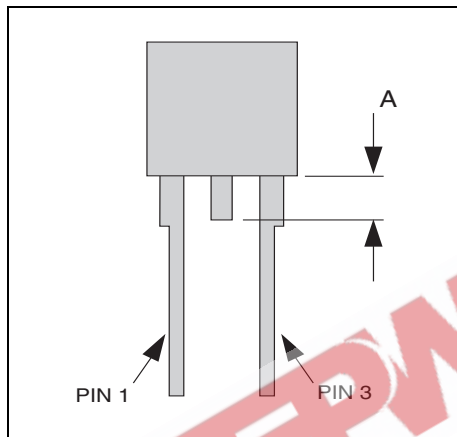

Dimension	Inches		Millimeters	
	Min	Max	Min	Max
A	0.030	0.060	0.762	1.52

Modified TO-220 Type 62

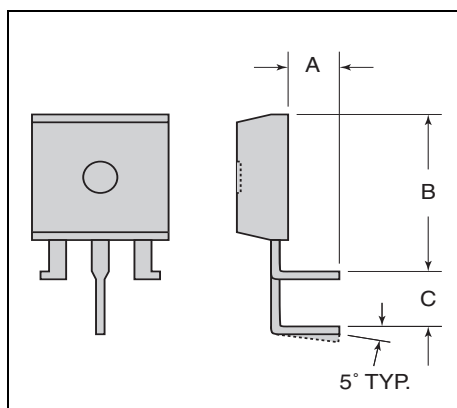

Dimension	Inches		Millimeters	
	Min	Max	Min	Max
A	0.172	0.202	4.37	5.13
B	0.440	0.460	11.18	11.68
C	0.120	0.130	3.05	3.30

Mechanical Data

NOTES

EEPW 电子产品世界
.com.cn
