

FEATURES

- 100MHz to 200MHz Fundamental or 3rd Overtone Crystal.
- Output range: 100 – 200MHz (no multiplication), 200 – 400MHz (2x multiplier), 400 – 700MHz (4x multiplier), or 800MHz-1GHz(PLL620-09 only, 8x multiplier).
- CMOS (Standard drive PLL620-07 or Selectable Drive PLL620-06), PECL (Enable low PLL620-08 or Enable high PLL620-05) or LVDS output (PLL620-09).
- Supports 3.3V-Power Supply.
- Available in 16-Pin (TSSOP or 3x3mm QFN)
Note: PLL620-06 only available in 3x3mm.
Note: PLL620-07 only available in TSSOP.

PIN CONFIGURATION
(Top View)

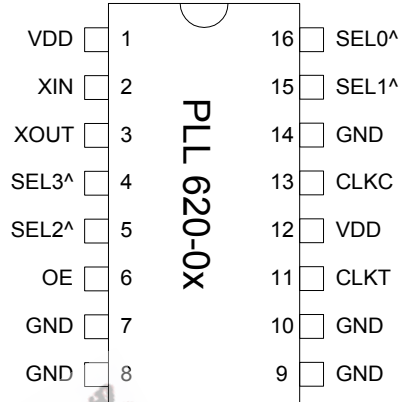

DESCRIPTION

The PLL620-0x family of XO IC's is specifically designed to work with high frequency fundamental and third overtone crystals. Their low jitter and low phase noise performance make them well suited for high frequency XO requirements. They achieve very low current into the crystal resulting in better overall stability.

BLOCK DIAGRAM

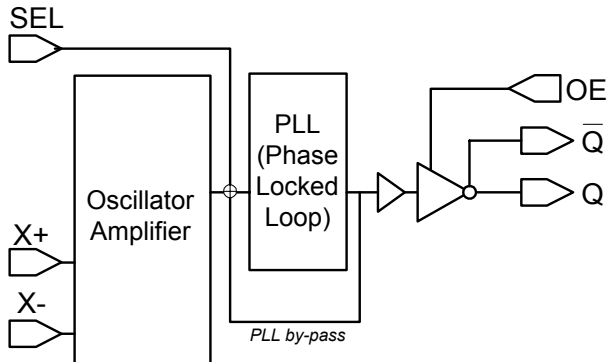

^: Internal pull-up
*: PLL620-06 pin 12 is output drive select (DRIVSEL)
(0 for High Drive CMOS, 1 for Standard Drive CMOS)
The pin remains 'Do Not Connect (DNC)' for PLL620-05/07/08/09.

OUTPUT ENABLE LOGICAL LEVELS

Part #	OE	State
PLL620-08	0 (Default)	Output enabled
	1	Tri-state
PLL620-05 PLL620-06 PLL620-07 PLL620-09	0 1 (Default)	Tri-state Output enabled

OE input: Logical states defined by PECL levels for PLL620-08
Logical states defined by CMOS levels for PLL620-05/-06/-07/-09

Low Phase Noise XO with multipliers (for 100-200MHz Fund or 3rdOT Xtal)

Universal Low Phase Noise IC's

PIN DESCRIPTIONS

Name	TSSOP* Pin number	3x3mm QFN* Pin number	Type	Description
VDD	1, 12	6,11	P	+3.3V power supply.
XIN	2	13	I	Crystal input. See Crystal Specification on page 3.
XOUT	3	14	I	Crystal output. See Crystal Specification on page 3.
OE	6	16	I	Output enable.
GND	7,8,9, 10, 14	1,2,3,4,8	P	Ground (except pin 12 on PLL620-06: DRIVSEL see below).
DRIVSEL**	-	12	I	PLL620-06 only: Drive Select Input. This pin has an internal pull-up that will default DRIVSEL to '1' when not connect to GND. CMOS output of PLL620-06 will be high drive CMOS when DRIVSEL is set to '0', and will be standard CMOS otherwise. The pin remains 'Do Not Connect (DNC)' for PLL620-05/07/08/09.
CLKT	11	5	O	True output PECL (PLL620-08) or LVDS (PLL620-09) (N/C for PLL620-07)
CLKC	13	7	O	Complementary output PECL (PLL620-08) or LVDS (PLL620-09) (CMOS out for PLL620-07).
SEL0	16	10	I	Multiplier selector pins. These pins have an internal pull-up that will default SEL to '1' when not connected to GND.
SEL1	15	9	I	
SEL2	5	15	I	
SEL3	4	Not available	I	

* Note: PLL620-06 only available in 3x3mm QFN, PLL620-07 only available in TSSOP.

** Note: DRIVSEL on pin 12 on PLL620-06 only. The pin remains 'Do Not Connect (DNC)' for PLL620-05/07/08/09.

FREQUENCY SELECTION TABLE

SEL3	SEL2	SEL1	SEL0	Selected Multiplier
0	0	1	1	Fin x 8(PLL620-09 only)
1	0	1	1	Fin x 4
1	1	1	0	Fin x 2
1	1	1	1	No multiplication

Note: SEL3 is not available (always "1") in 3x3mm package

All pins have internal pull-ups (default value is 1). Connect to GND to set to 0.

ELECTRICAL SPECIFICATIONS

1. Absolute Maximum Ratings

PARAMETERS	SYMBOL	MIN.	MAX.	UNITS
Supply Voltage	V_{DD}		4.6	V
Input Voltage, dc	V_I	-0.5	$V_{DD}+0.5$	V
Output Voltage, dc	V_O	-0.5	$V_{DD}+0.5$	V
Storage Temperature	T_S	-65	150	°C
Ambient Operating Temperature*	T_A	-40	85	°C
Junction Temperature	T_J		125	°C
Lead Temperature (soldering, 10s)			260	°C
ESD Protection, Human Body Model			2	kV

Exposure of the device under conditions beyond the limits specified by Maximum Ratings for extended periods may cause permanent damage to the device and affect product reliability. These conditions represent a stress rating only, and functional operations of the device at these or any other conditions above the operational limits noted in this specification is not implied.

* **Note:** Operating Temperature is guaranteed by design for all parts (COMMERCIAL and INDUSTRIAL), but tested for COMMERCIAL grade only.

2. Crystal Specifications

PARAMETERS	SYMBOL	CONDITIONS	MIN.	TYP.	MAX.	UNITS
Crystal Resonator Frequency	F_{XIN}	Fundamental or 3 rd overtone*	100		200	MHz
Crystal Loading Rating	$C_L(xtal)$			5		pF
Interelectrode Capacitance	C_0				5	pF
Recommended ESR	R_E	AT cut			30	Ω

* **Note:** 3rd overtone crystals require an external resistor between XIN and XOUT to prevent the fundamental from oscillating.

3. General Electrical Specifications

PARAMETERS	SYMBOL	CONDITIONS	MIN.	TYP.	MAX.	UNITS
Supply Current (Loaded Outputs)	I_{DD}	PECL/LVDS/CMOS			100/80/40	mA
Operating Voltage	V_{DD}		2.97		3.63	V
Output Clock Duty Cycle		@ 50% V_{DD} (CMOS) @ 1.25V (LVDS) @ $V_{DD} - 1.3V$ (PECL)	45	50	55	%
Short Circuit Current				± 50		mA

Low Phase Noise XO with multipliers (for 100-200MHz Fund or 3rdOT Xtal)

Universal Low Phase Noise IC's

4. Jitter Specifications

PARAMETERS	CONDITIONS	MIN.	TYP.	MAX.	UNITS
Period jitter RMS	At 155.52MHz, with capacitive decoupling between VDD and GND. Over 10,000 cycles		2.5		ps
Period jitter peak-to-peak			18.5	20	
Accumulated jitter RMS	At 155.52MHz, with capacitive decoupling between VDD and GND. Over 1,000,000 cycles.		2.5		ps
Accumulated jitter peak-to-peak			24	27	
Random Jitter	"RJ" measured on Wavecrest SIA 3000		2.5		ps
Integrated jitter RMS at 155MHz	Integrated 12 kHz to 20 MHz		0.3	0.4	ps
Period jitter RMS	At 622.08MHz, with capacitive decoupling between VDD and GND. Over 10,000 cycles		11		ps
Period jitter peak-to-peak			45	49	
Accumulated jitter RMS	At 622.08MHz, with capacitive decoupling between VDD and GND. Over 1,000,000 cycles.		11		ps
Accumulated jitter peak-to-peak			24	27	
Random Jitter	"RJ" measured on Wavecrest SIA 3000		3		ps
Integrated jitter RMS at 622MHz	Integrated 12 kHz to 20 MHz		1.6	1.8	ps

5. Phase Noise Specifications

PARAMETERS	FREQUENCY	@10Hz	@100Hz	@1kHz	@10kHz	@100kHz	UNITS
Phase Noise relative to carrier	155.52MHz	-75	-95	-125	-140	-145	dBc/Hz
	622.08MHz	-75	-95	-110	-125	-120	

6. CMOS Electrical Specifications

PARAMETERS	SYMBOL	CONDITIONS	MIN.	TYP.	MAX.	UNITS
Output drive current (High Drive)	I _{OH}	V _{OH} = V _{DD} -0.4V, V _{DD} =3.3V	30			mA
	I _{OL}	V _{OL} = 0.4V, V _{DD} = 3.3V	30			mA
Output drive current (Standard Drive)	I _{OH}	V _{OH} = V _{DD} -0.4V, V _{DD} =3.3V	10			mA
	I _{OL}	V _{OL} = 0.4V, V _{DD} = 3.3V	10			mA
Output Clock Rise/Fall Time (Standard Drive)		0.3V ~ 3.0V with 15 pF load		2.4		ns
Output Clock Rise/Fall Time (High Drive)		0.3V ~ 3.0V with 15 pF load		1.2		

* Note: High Drive CMOS is available on PLL620-06 through DRIVSEL selector input on pin 12.

Low Phase Noise XO with multipliers (for 100-200MHz Fund or 3rdOT Xtal)
Universal Low Phase Noise IC's

7. LVDS Electrical Characteristics

PARAMETERS	SYMBOL	CONDITIONS	MIN.	TYP.	MAX.	UNITS
Output Differential Voltage	V_{OD}	$R_L = 100 \Omega$ (see figure)	247	355	454	mV
V_{DD} Magnitude Change	ΔV_{OD}		-50		50	mV
Output High Voltage	V_{OH}			1.4	1.6	V
Output Low Voltage	V_{OL}		0.9	1.1		V
Offset Voltage	V_{OS}		1.125	1.2	1.375	V
Offset Magnitude Change	ΔV_{OS}		0	3	25	mV
Power-off Leakage	I_{OXD}	$V_{out} = V_{DD}$ or GND $V_{DD} = 0V$		± 1	± 10	μA
Output Short Circuit Current	I_{OSD}			-5.7	-8	mA

8. LVDS Switching Characteristics

PARAMETERS	SYMBOL	CONDITIONS	MIN.	TYP.	MAX.	UNITS
Differential Clock Rise Time	t_r	$R_L = 100 \Omega$ $C_L = 10 \text{ pF}$ (see figure)	0.2	0.7	1.0	ns
Differential Clock Fall Time	t_f		0.2	0.7	1.0	ns

LVDS Levels Test Circuit

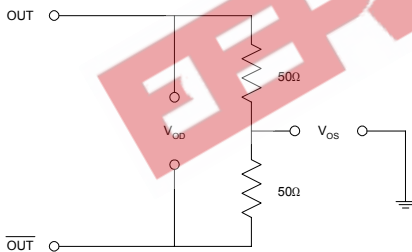

LVDS Switching Test Circuit

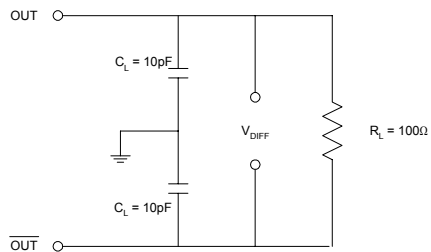

LVDS Transistion Time Waveform

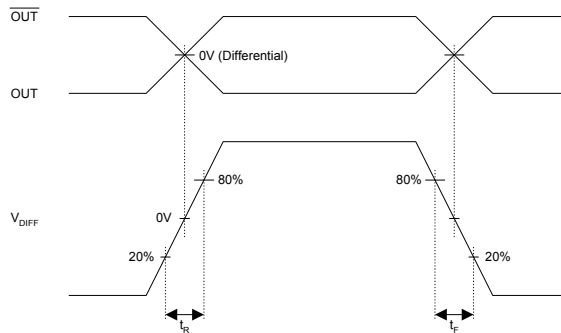

9. PECL Electrical Characteristics

PARAMETERS	SYMBOL	CONDITIONS	MIN.	MAX.	UNITS
Output High Voltage	V_{OH}	$R_L = 50 \Omega$ to $(V_{DD} - 2V)$ (see figure)	$V_{DD} - 1.025$		V
Output Low Voltage	V_{OL}			$V_{DD} - 1.620$	V

19. PECL Switching Characteristics

PARAMETERS	SYMBOL	CONDITIONS	MIN.	TYP.	MAX.	UNITS
Clock Rise Time	t_r	@20/80% - PECL		0.6	1.5	ns
Clock Fall Time	t_f	@80/20% - PECL		0.5	1.5	ns

PECL Levels Test Circuit

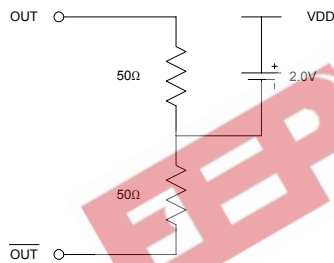

PECL Output Skew

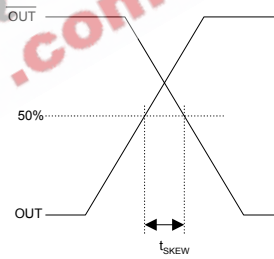

PECL Transition Time Waveform

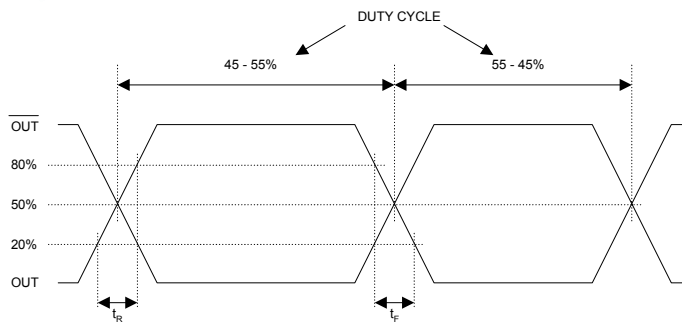

Low Phase Noise XO with multipliers (for 100-200MHz Fund or 3rdOT Xtal)
Universal Low Phase Noise IC's

PACKAGE INFORMATION

16 PIN TSSOP (mm)		
Symbol	Min.	Max.
A	-	1.20
A1	0.05	0.15
B	0.19	0.30
C	0.09	0.20
D	4.90	5.10
E	4.30	4.50
H	6.40 BSC	
L	0.45	0.75
e	0.65 BSC	

3mm x 3mm, QFN

VARIATIONS:

SYMBOL	16 LD		
	MIN	NOM	MAX
e	0.50 BSC		
b	0.18	0.23	0.30
L	0.30	0.40	0.50
ND	4		
NE	4		

Low Phase Noise XO with multipliers (for 100-200MHz Fund or 3rdOT Xtal)
Universal Low Phase Noise IC's

ORDERING INFORMATION

For part ordering, please contact our Sales Department:

47745 Fremont Blvd., Fremont, CA 94538, USA
Tel: (510) 492-0990 Fax: (510) 492-0991

PART NUMBER

The order number for this device is a combination of the following:
Device number, Package type and Operating temperature range

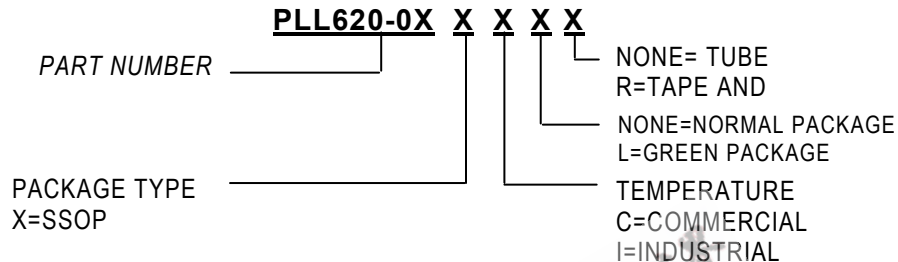

Order Number	Marking	Package Option	Order Number	Marking	Package Option
PLL620-05OC	P620-05OC	TSSOP – Tube	PLL620-08OC	P620-08OC	TSSOP – Tube
PLL620-05OC-R	P620-05OC	TSSOP – Tape & Reel	PLL620-08OC-R	P620-08OC	TSSOP – Tape & Reel
PLL620-05OCL	P620-05OCL	TSSOP – Tube, GREEN	PLL620-08OCL	P620-08OCL	TSSOP – Tube, GREEN
PLL620-05OCL-R	P620-05OCL	TSSOP – Tape & Reel, GREEN	PLL620-08OCL-R	P620-08OCL	TSSOP – Tape & Reel, GREEN
PLL620-05QC	P620-05QC	QFN – Tube	PLL620-08QC	P620-08QC	QFN – Tube
PLL620-05QC-R	P620-05QC	QFN – Tape & Reel	PLL620-08QC-R	P620-08QC	QFN – Tape & Reel
PLL620-05QCL	P620-05QCL	QFN – Tube, GREEN	PLL620-08QCL	P620-08QCL	QFN – Tube, GREEN
PLL620-05QCL-R	P620-05QCL	QFN – Tape & Reel, GREEN	PLL620-08QCL-R	P620-08QCL	QFN – Tape & Reel, GREEN
PLL620-06QC	P620-06QC	QFN – Tube	PLL620-09OC	P620-09OC	TSSOP – Tube
PLL620-06QC-R	P620-06QC	QFN – Tape & Reel	PLL620-09OC-R	P620-09OC	TSSOP – Tape & Reel
PLL620-06QCL	P620-06QCL	QFN – Tube, GREEN	PLL620-09OCL	P620-09OCL	TSSOP – Tube, GREEN
PLL620-06QCL-R	P620-06QCL	QFN – Tape & Reel, GREEN	PLL620-09OCL-R	P620-09OCL	TSSOP – Tape & Reel, GREEN
PLL620-07OC	P620-07OC	TSSOP – Tube	PLL620-09QC	P620-09QC	QFN – Tube
PLL620-07OC-R	P620-07OC	TSSOP – Tape & Reel	PLL620-09QC-R	P620-09QC	QFN – Tape & Reel
PLL620-07OCL	P620-07OCL	TSSOP – Tube, GREEN	PLL620-09QCL	P620-09QCL	QFN – Tube, GREEN
PLL620-07OCL-R	P620-07OCL	TSSOP – Tape & Reel, GREEN	PLL620-09QCL-R	P620-09QCL	QFN – Tape & Reel, GREEN

PhaseLink Corporation, reserves the right to make changes in its products or specifications, or both at any time without notice. The information furnished by Phaselink is believed to be accurate and reliable. However, PhaseLink makes no guarantee or warranty concerning the accuracy of said information and shall not be responsible for any loss or damage of whatever nature resulting from the use of, or reliance upon this product.

LIFE SUPPORT POLICY: PhaseLink's products are not authorized for use as critical components in life support devices or systems without the express written approval of the President of PhaseLink Corporation.