

P6KE6.8 THRU P6KE440CA

TRANSZORB™ TRANSIENT VOLTAGE SUPPRESSOR
Breakdown Voltage - 6.8 to 440 Volts Peak Pulse Power- 600 Watts

DO-204AC

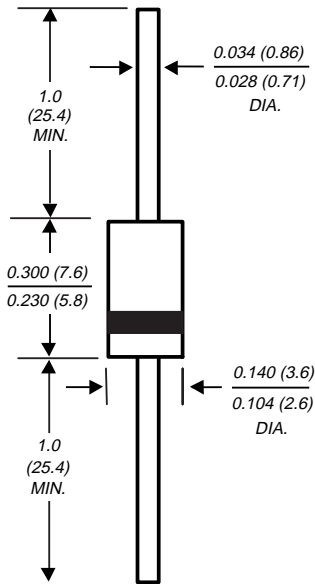

Dimensions in inches
and
(millimeters)

FEATURES

- ◆ Plastic package has Underwriters Laboratory Flammability Classification 94V-0
- ◆ Glass passivated junction
- ◆ 600W peak pulse power capability with a 10/1000 μ s waveform, repetition rate (duty cycle): 0.01%
- ◆ Excellent clamping capability
- ◆ Low incremental surge resistance
- ◆ Fast response time: typically less than 1.0ps from 0 Volts to $V_{(BR)}$ for uni-directional and 5.0ns for bi-directional types
- ◆ Typical I_D less than 1 μ A above 10V
- ◆ High temperature soldering guaranteed: 265°C/10 seconds, 0.375" (9.5mm) lead length, 5lbs. (2.3 kg) tension



MECHANICAL DATA

Case: JEDEC DO-204AC molded plastic body over passivated junction

Terminals: Solder plated axial leads, solderable per MIL-STD-750, Method 2026

Polarity: For uni-directional types the color band denotes the cathode, which is positive with respect to the anode under normal TVS operation

Mounting Position: Any

Weight: 0.015 ounce, 0.4 gram

DEVICES FOR BIDIRECTIONAL APPLICATIONS

For bi-directional use C or CA Suffix for types P6KE6.8 thru types P6KE440 (e.g. P6KE6.8C, P6KE440CA).
 Electrical characteristics apply in both directions.

MAXIMUM RATINGS AND CHARACTERISTICS

Ratings at 25°C ambient temperature unless otherwise specified.

	SYMBOL	VALUE	UNITS
Peak pulse power dissipation with a 10/1000 μ s waveform (NOTE 1, FIG. 1)	P _{PPM}	Minimum 600	Watts
Peak pulse current with a 10/1000 μ s waveform (NOTE 1)	I _{PPM}	SEE TABLE 1	Amps
Steady state power dissipation at $T_L=75^\circ\text{C}$ lead lengths, 0.375" (9.5mm) (NOTE 2)	P _{M(AV)}	5.0	Watts
Peak forward surge current, 8.3ms single half sine-wave superimposed on rated load (JEDEC Method) unidirectional only (NOTE 3)	I _{FSM}	100.0	Amps
Maximum instantaneous forward voltage at 50.0A for unidirectional only (NOTE 4)	V _F	3.5/5.0	Volts
Operating junction and storage temperature range	T _J , T _{STG}	-55 to +175	°C

NOTES:

- (1) Non-repetitive current pulse, per Fig. 3 and derated above $T_A=25^\circ\text{C}$ per Fig. 2
- (2) Mounted on copper pad area of 1.6 x 1.6" (40 x 40mm) per Fig. 5
- (3) Measured on 8.3ms single half sine-wave or equivalent square wave duty cycle=4 pulses per minute maximum
- (4) $V_F=3.5$ Volt max. for devices of $V_{(BR)}\leq 220\text{V}$, and $V_F=5.0\text{V}$ for devices of $V_{(BR)}>220\text{V}$

ELECTRICAL CHARACTERISTICS at (TA=25°C unless otherwise noted) TABLE 1

Device Type	Breakdown Voltage V(BR) Volts (NOTE 1)		Test Current at I _T (mA)	Stand-off Voltage V _{WM} (Volts)	Maximum Reverse Leakage at V _{WM} I _D (μA) (NOTE 3)	Maximum Peak Pulse Current I _{PPM} (Amps) (NOTE 2)	Maximum Clamping Voltage at I _{PPM} V _C (Volts)	Maximum Temperature Coefficient of V(BR) (% / C)
	MIN	MAX						
+P6KE6.8	6.12	7.48	10	5.50	1000	55.6	10.8	0.057
+P6KE6.8A	6.45	7.14	10	5.80	1000	57.1	10.5	0.057
+P6KE7.5	6.75	8.25	10	6.05	500	51.3	11.7	0.061
+P6KE7.5A	7.13	7.88	10	6.40	500	53.1	11.3	0.061
+P6KE8.2	7.38	9.02	10	6.63	200	48.0	12.5	0.065
+P6KE8.2A	7.79	8.61	10	7.02	200	49.6	12.1	0.065
+P6KE9.1	8.19	10.0	1.0	7.37	50	43.5	13.8	0.068
+P6KE9.1A	8.65	9.55	1.0	7.78	50	44.8	13.4	0.068
+P6KE10	9.00	11.0	1.0	8.10	10	40.0	15.0	0.073
+P6KE10A	9.50	10.5	1.0	8.55	10	41.4	14.5	0.073
+P6KE11	9.90	12.1	1.0	8.92	5.0	37.0	16.2	0.075
+P6KE11A	10.5	11.6	1.0	9.40	5.0	38.5	15.6	0.075
+P6KE12	10.8	13.2	1.0	9.72	5.0	34.7	17.3	0.078
+P6KE12A	11.4	12.6	1.0	10.2	5.0	35.9	16.7	0.078
+P6KE13	11.7	14.3	1.0	10.5	5.0	31.6	19.0	0.081
+P6KE13A	12.4	13.7	1.0	11.1	5.0	33.0	18.2	0.081
+P6KE15	13.5	16.5	1.0	12.1	5.0	27.3	22.0	0.084
+P6KE15A	14.3	15.8	1.0	12.8	5.0	28.3	21.2	0.084
+P6KE16	14.4	17.6	1.0	12.9	5.0	25.5	23.5	0.086
+P6KE16A	15.2	16.8	1.0	13.6	5.0	26.7	22.5	0.086
+P6KE18	16.2	19.8	1.0	14.5	5.0	22.6	26.5	0.088
+P6KE18A	17.1	18.9	1.0	15.3	5.0	23.8	25.2	0.088
+P6KE20	18.0	22.0	1.0	16.2	5.0	20.6	29.1	0.090
+P6KE20A	19.0	21.0	1.0	17.1	5.0	21.7	27.7	0.090
+P6KE22	19.8	24.2	1.0	17.8	5.0	18.8	31.9	0.092
+P6KE22A	20.9	23.1	1.0	18.8	5.0	19.6	30.6	0.092
+P6KE24	21.6	26.4	1.0	19.4	5.0	17.3	34.7	0.094
+P6KE24A	22.8	25.2	1.0	20.5	5.0	18.1	33.2	0.094
+P6KE27	24.3	29.7	1.0	21.8	5.0	15.3	39.1	0.096
+P6KE27A	25.7	28.4	1.0	23.1	5.0	16.0	37.5	0.096
+P6KE30	27.0	33.0	1.0	24.3	5.0	13.8	43.5	0.097
+P6KE30A	28.5	31.5	1.0	25.6	5.0	14.5	41.4	0.097
+P6KE33	29.7	36.3	1.0	26.8	5.0	12.6	47.7	0.098
+P6KE33A	31.4	34.7	1.0	28.2	5.0	13.1	45.7	0.098
+P6KE36	32.4	39.6	1.0	29.1	5.0	11.5	52.0	0.099
+P6KE36A	34.2	37.8	1.0	30.8	5.0	12.0	49.9	0.099
+P6KE39	35.1	42.9	1.0	31.6	5.0	10.6	56.4	0.100
+P6KE39A	37.1	41.0	1.0	33.3	5.0	11.1	53.9	0.100
+P6KE43	38.7	47.3	1.0	34.8	5.0	9.7	61.9	0.101
+P6KE43A	40.9	45.2	1.0	36.8	5.0	10.1	59.3	0.101
+P6KE47	42.3	51.7	1.0	38.1	5.0	8.8	67.8	0.101
+P6KE47A	44.7	49.4	1.0	40.2	5.0	9.3	64.8	0.101
P6KE51	45.9	56.1	1.0	41.3	5.0	8.2	73.5	0.102
P6KE51A	48.5	53.6	1.0	43.6	5.0	8.6	70.1	0.102
P6KE56	50.4	61.6	1.0	45.4	5.0	7.5	80.5	0.103
P6KE56A	53.2	58.8	1.0	47.8	5.0	7.8	77.0	0.103
P6KE62	55.8	68.2	1.0	50.2	5.0	6.7	89.0	0.104
P6KE62A	58.9	65.1	1.0	53.0	5.0	7.1	85.0	0.104
P6KE68	61.2	74.8	1.0	55.1	5.0	6.1	98.0	0.104
P6KE68A	64.6	71.4	1.0	58.1	5.0	6.5	92.0	0.104
P6KE75	67.5	82.5	1.0	60.7	5.0	5.6	108	0.105
P6KE75A	71.3	78.8	1.0	64.1	5.0	5.8	103	0.105
P6KE82	73.8	90.2	1.0	66.4	5.0	5.1	118	0.105
P6KE82A	77.9	86.1	1.0	70.1	5.0	5.3	113	0.105
P6KE91	81.9	100	1.0	73.7	5.0	4.6	131	0.106

+UL listed for Telecom application protection 497B, file number E136766 for both uni-directional and bi-directional devices

ELECTRICAL CHARACTERISTICS at (TA=25°C unless otherwise noted) TABLE (Cont'd)

Device Type	Breakdown Voltage V _(BR) Volts (NOTE 1)		Test Current at I _T (mA)	Stand-off Voltage V _{WM} (Volts)	Maximum Reverse Leakage at V _{WM} I _D (μA) (NOTE3)	Maximum Peak Pulse Current I _{PPM} (Amps) (NOTE 2)	Maximum Clamping Voltage at I _{PPM} V _C (Volts)	Maximum Temperature Coefficient of V _(BR) (% / C)
	MIN	MAX						
P6KE91A	86.5	95.5	1.0	77.8	5.0	4.8	125	0.106
P6KE100	90.0	110	1.0	81.0	5.0	4.2	144	0.106
P6KE100A	95.0	105	1.0	85.5	5.0	4.4	137	0.106
P6KE110	99.0	121	1.0	89.2	5.0	3.8	158	0.107
P6KE110A	105	116	1.0	94.0	5.0	3.9	152	0.107
P6KE120	108	132	1.0	97.2	5.0	3.5	173	0.107
P6KE120A	114	126	1.0	102	5.0	3.6	165	0.107
P6KE130	117	143	1.0	105	5.0	3.2	187	0.107
P6KE130A	124	137	1.0	111	5.0	3.4	179	0.107
P6KE150	135	165	1.0	121	5.0	2.8	215	0.108
P6KE150A	143	158	1.0	128	5.0	2.9	207	0.108
P6KE160	144	176	1.0	130	5.0	2.6	230	0.108
P6KE160A	152	168	1.0	136	5.0	2.7	219	0.108
P6KE170	153	187	1.0	138	5.0	2.5	244	0.108
P6KE170A	162	179	1.0	145	5.0	2.6	234	0.108
P6KE180	162	198	1.0	146	5.0	2.3	258	0.108
P6KE180A	171	189	1.0	154	5.0	2.4	246	0.108
P6KE200	180	220	1.0	162	5.0	2.1	287	0.108
P6KE200A	190	210	1.0	171	5.0	2.2	274	0.108
P6KE220	198	242	1.0	175	5.0	1.7	344	0.108
P6KE220A	209	231	1.0	185	5.0	1.8	328	0.108
P6KE250	225	275	1.0	202	5.0	1.7	360	0.110
P6KE250A	237	263	1.0	214	5.0	1.7	344	0.110
P6KE300	270	330	1.0	243	5.0	1.4	430	0.110
P6KE300A	285	315	1.0	256	5.0	1.4	414	0.110
P6KE350	315	385	1.0	284	5.0	1.2	504	0.110
P6KE350A	333	368	1.0	300	5.0	1.2	482	0.110
P6KE400	360	440	1.0	324	5.0	1.0	574	0.110
P6KE400A	380	420	1.0	342	5.0	1.1	548	0.110
P6KE440	396	484	1.0	356	5.0	0.95	631	0.110
P6KE440A	418	462	1.0	376	5.0	1.0	602	0.110

NOTES:

- (1) V_(BR) measured after I_T applied for 300μs, I_T=square wave pulse or equivalent
 - (2) Surge current waveform per Fig. 3 and derate per Fig. 2
 - (3) For bidirectional types with V_{WM} of 10 volts and less, the I_D limit is doubled
 - (4) All terms and symbols are consistent with ANSI/IEEE C62.35
- +UL listed for Telecom application protection 497B, file number E136766 for both uni-directional and bi-directional devices

DESCRIPTION

This P6KE TVS series is a low cost commercial product for use in applications where large voltage transients can permanently damage voltage-sensitive components.

The P6KE series device types are designed in a small package size where power and space is a consideration. They are characterized by their high surge capability, extremely fast response time, and low impedance, (R_{ON}). Because of the unpredictable nature of transients, and the variation of the impedance with respect to these transients, impedance, per se, is not specified as a parametric value. However, a minimum voltage at low current conditions (BV) and a maximum clamping voltage (V_C) at a maximum peak pulse current is specified.

In some instances, the thermal effect (see V_C Clamping Voltage) may be responsible for 50% to 70% of the observed voltage differential when subjected to high current pulses for several duty cycles, thus making a maximum impedance specification insignificant. In case of a severe current overload or abnormal transient beyond the maximum ratings, the Transient Voltage Suppressor will initially fail 'short' thus tripping the system's circuit breaker or fuse while protecting the entire circuit. Curves depicting clamping voltage vs. various current pulses are available from the factory. Extended power curves vs. pulse time are also available.

RATINGS AND CHARACTERISTIC CURVES P6KE6.8 THRU P6KE440CA

FIG. 1 - PEAK PULSE POWER RATING CURVE

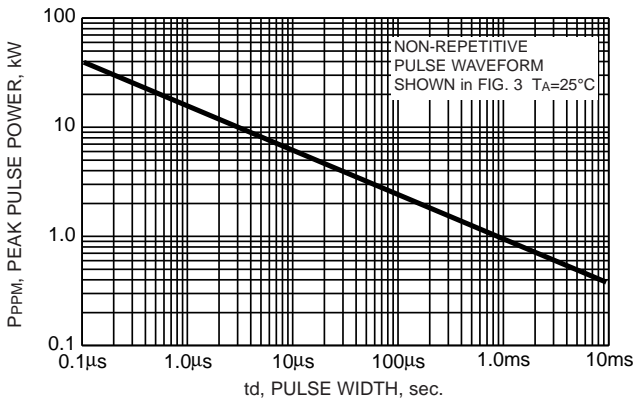

FIG. 2 - PULSE DERATING CURVE

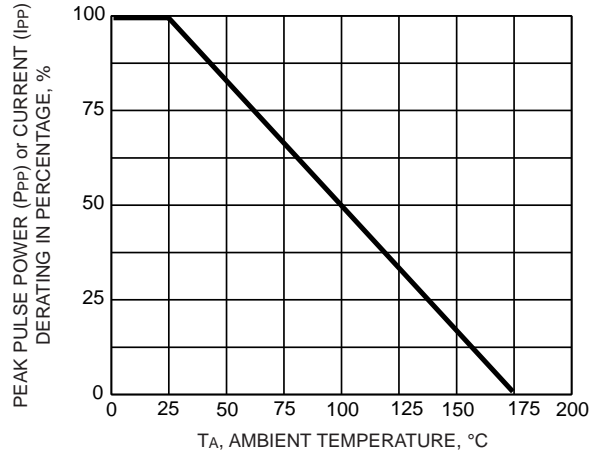

FIG. 3 - PULSE WAVEFORM

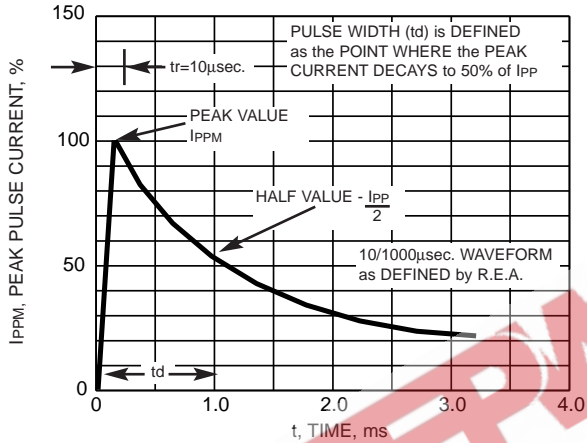

FIG. 4 - TYPICAL JUNCTION CAPACITANCE UNIDIRECTIONAL

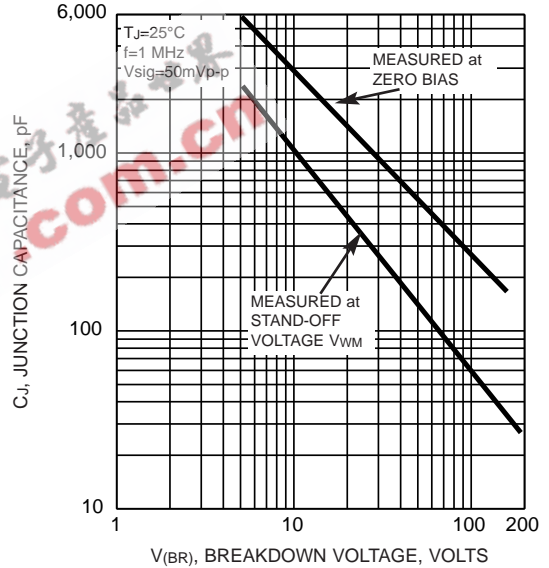

FIG. 5 - STEADY STATE POWER DERATING CURVE

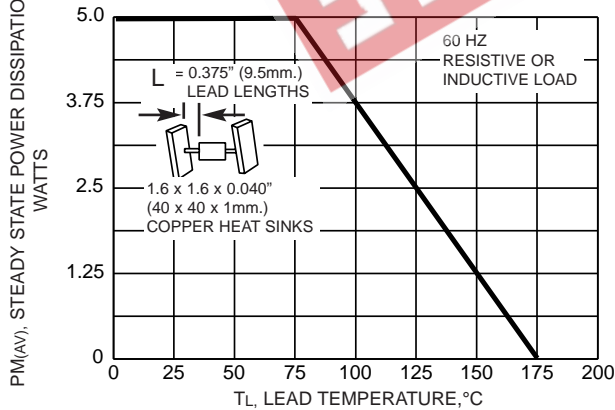

FIG. 6 - MAXIMUM NON-REPETITIVE FORWARD SURGE CURRENT UNI-DIRECTIONAL

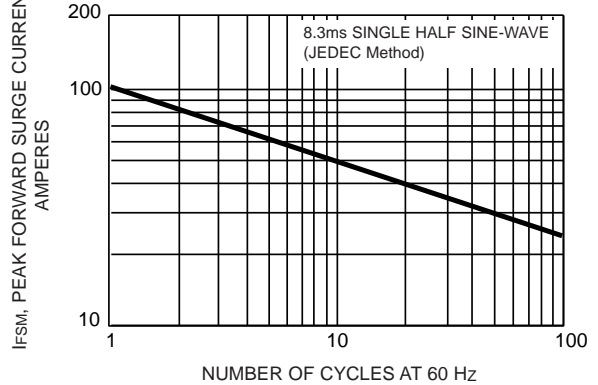

FIG. 7 - TYPICAL REVERSE LEAKAGE CHARACTERISTICS

