

P6KE6.8 THRU P6KE440CA

TRANSZORB™ TRANSIENT VOLTAGE SUPPRESSOR
Breakdown Voltage - 6.8 to 440 Volts Peak Pulse Power- 600 Watts

DO-204AC

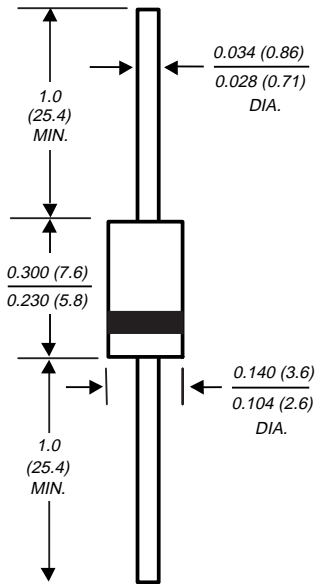

Dimensions in inches
and
(millimeters)

FEATURES

- ◆ Plastic package has Underwriters Laboratory Flammability Classification 94V-0
- ◆ Glass passivated junction
- ◆ 600W peak pulse power capability with a 10/1000 μ s waveform, repetition rate (duty cycle): 0.01%
- ◆ Excellent clamping capability
- ◆ Low incremental surge resistance
- ◆ Fast response time: typically less than 1.0ps from 0 Volts to $V_{(BR)}$ for uni-directional and 5.0ns for bi-directional types
- ◆ Typical I_D less than 1 μ A above 10V
- ◆ High temperature soldering guaranteed: 265°C/10 seconds, 0.375" (9.5mm) lead length, 5lbs. (2.3 kg) tension



MECHANICAL DATA

Case: JEDEC DO-204AC molded plastic body over passivated junction

Terminals: Solder plated axial leads, solderable per MIL-STD-750, Method 2026

Polarity: For uni-directional types the color band denotes the cathode, which is positive with respect to the anode under normal TVS operation

Mounting Position: Any

Weight: 0.015 ounce, 0.4 gram

DEVICES FOR BIDIRECTIONAL APPLICATIONS

For bi-directional use C or CA Suffix for types P6KE6.8 thru types P6KE440 (e.g. P6KE6.8C, P6KE440CA). Electrical characteristics apply in both directions.

MAXIMUM RATINGS AND CHARACTERISTICS

Ratings at 25°C ambient temperature unless otherwise specified.

| | SYMBOL | VALUE | UNITS |
|--|-----------------------------------|-------------|-------|
| Peak pulse power dissipation with a 10/1000 μ s waveform (NOTE 1, FIG. 1) | P _{PPM} | Minimum 600 | Watts |
| Peak pulse current with a 10/1000 μ s waveform (NOTE 1) | I _{PPM} | SEE TABLE 1 | Amps |
| Steady state power dissipation at $T_L=75^\circ\text{C}$ lead lengths, 0.375" (9.5mm) (NOTE 2) | P _{M(AV)} | 5.0 | Watts |
| Peak forward surge current, 8.3ms single half sine-wave superimposed on rated load (JEDEC Method) unidirectional only (NOTE 3) | I _{FSM} | 100.0 | Amps |
| Maximum instantaneous forward voltage at 50.0A for unidirectional only (NOTE 4) | V _F | 3.5/5.0 | Volts |
| Operating junction and storage temperature range | T _J , T _{STG} | -55 to +175 | °C |

NOTES:

- (1) Non-repetitive current pulse, per Fig. 3 and derated above $T_A=25^\circ\text{C}$ per Fig. 2
- (2) Mounted on copper pad area of 1.6 x 1.6" (40 x 40mm) per Fig. 5
- (3) Measured on 8.3ms single half sine-wave or equivalent square wave duty cycle=4 pulses per minute maximum
- (4) $V_F=3.5$ Volt max. for devices of $V_{(BR)}\leq 220\text{V}$, and $V_F=5.0\text{V}$ for devices of $V_{(BR)}>220\text{V}$

ELECTRICAL CHARACTERISTICS at (TA=25°C unless otherwise noted) TABLE 1

| Device Type | Breakdown Voltage V(BR) Volts (NOTE 1) | | Test Current at Ir (mA) | Stand-off Voltage Vwm (Volts) | Maximum Reverse Leakage at Vwm Id (µA) (NOTE3) | Maximum Peak Pulse Current IPPM (Amps) (NOTE 2) | Maximum Clamping Voltage at IPPM Vc (Volts) | Maximum Temperature Coefficient of V(BR) (% / C) |
|-------------|--|------|-------------------------|-------------------------------|--|---|---|--|
| | MIN | MAX | | | | | | |
| +P6KE6.8 | 6.12 | 7.48 | 10 | 5.50 | 1000 | 55.6 | 10.8 | 0.057 |
| +P6KE6.8A | 6.45 | 7.14 | 10 | 5.80 | 1000 | 57.1 | 10.5 | 0.057 |
| +P6KE7.5 | 6.75 | 8.25 | 10 | 6.05 | 500 | 51.3 | 11.7 | 0.061 |
| +P6KE7.5A | 7.13 | 7.88 | 10 | 6.40 | 500 | 53.1 | 11.3 | 0.061 |
| +P6KE8.2 | 7.38 | 9.02 | 10 | 6.63 | 200 | 48.0 | 12.5 | 0.065 |
| +P6KE8.2A | 7.79 | 8.61 | 10 | 7.02 | 200 | 49.6 | 12.1 | 0.065 |
| +P6KE9.1 | 8.19 | 10.0 | 1.0 | 7.37 | 50 | 43.5 | 13.8 | 0.068 |
| +P6KE9.1A | 8.65 | 9.55 | 1.0 | 7.78 | 50 | 44.8 | 13.4 | 0.068 |
| +P6KE10 | 9.00 | 11.0 | 1.0 | 8.10 | 10 | 40.0 | 15.0 | 0.073 |
| +P6KE10A | 9.50 | 10.5 | 1.0 | 8.55 | 10 | 41.4 | 14.5 | 0.073 |
| +P6KE11 | 9.90 | 12.1 | 1.0 | 8.92 | 5.0 | 37.0 | 16.2 | 0.075 |
| +P6KE11A | 10.5 | 11.6 | 1.0 | 9.40 | 5.0 | 38.5 | 15.6 | 0.075 |
| +P6KE12 | 10.8 | 13.2 | 1.0 | 9.72 | 5.0 | 34.7 | 17.3 | 0.078 |
| +P6KE12A | 11.4 | 12.6 | 1.0 | 10.2 | 5.0 | 35.9 | 16.7 | 0.078 |
| +P6KE13 | 11.7 | 14.3 | 1.0 | 10.5 | 5.0 | 31.6 | 19.0 | 0.081 |
| +P6KE13A | 12.4 | 13.7 | 1.0 | 11.1 | 5.0 | 33.0 | 18.2 | 0.081 |
| +P6KE15 | 13.5 | 16.5 | 1.0 | 12.1 | 5.0 | 27.3 | 22.0 | 0.084 |
| +P6KE15A | 14.3 | 15.8 | 1.0 | 12.8 | 5.0 | 28.3 | 21.2 | 0.084 |
| +P6KE16 | 14.4 | 17.6 | 1.0 | 12.9 | 5.0 | 25.5 | 23.5 | 0.086 |
| +P6KE16A | 15.2 | 16.8 | 1.0 | 13.6 | 5.0 | 26.7 | 22.5 | 0.086 |
| +P6KE18 | 16.2 | 19.8 | 1.0 | 14.5 | 5.0 | 22.6 | 26.5 | 0.088 |
| +P6KE18A | 17.1 | 18.9 | 1.0 | 15.3 | 5.0 | 23.8 | 25.2 | 0.088 |
| +P6KE20 | 18.0 | 22.0 | 1.0 | 16.2 | 5.0 | 20.6 | 29.1 | 0.090 |
| +P6KE20A | 19.0 | 21.0 | 1.0 | 17.1 | 5.0 | 21.7 | 27.7 | 0.090 |
| +P6KE22 | 19.8 | 24.2 | 1.0 | 17.8 | 5.0 | 18.8 | 31.9 | 0.092 |
| +P6KE22A | 20.9 | 23.1 | 1.0 | 18.8 | 5.0 | 19.6 | 30.6 | 0.092 |
| +P6KE24 | 21.6 | 26.4 | 1.0 | 19.4 | 5.0 | 17.3 | 34.7 | 0.094 |
| +P6KE24A | 22.8 | 25.2 | 1.0 | 20.5 | 5.0 | 18.1 | 33.2 | 0.094 |
| +P6KE27 | 24.3 | 29.7 | 1.0 | 21.8 | 5.0 | 15.3 | 39.1 | 0.096 |
| +P6KE27A | 25.7 | 28.4 | 1.0 | 23.1 | 5.0 | 16.0 | 37.5 | 0.096 |
| +P6KE30 | 27.0 | 33.0 | 1.0 | 24.3 | 5.0 | 13.8 | 43.5 | 0.097 |
| +P6KE30A | 28.5 | 31.5 | 1.0 | 25.6 | 5.0 | 14.5 | 41.4 | 0.097 |
| +P6KE33 | 29.7 | 36.3 | 1.0 | 26.8 | 5.0 | 12.6 | 47.7 | 0.098 |
| +P6KE33A | 31.4 | 34.7 | 1.0 | 28.2 | 5.0 | 13.1 | 45.7 | 0.098 |
| +P6KE36 | 32.4 | 39.6 | 1.0 | 29.1 | 5.0 | 11.5 | 52.0 | 0.099 |
| +P6KE36A | 34.2 | 37.8 | 1.0 | 30.8 | 5.0 | 12.0 | 49.9 | 0.099 |
| +P6KE39 | 35.1 | 42.9 | 1.0 | 31.6 | 5.0 | 10.6 | 56.4 | 0.100 |
| +P6KE39A | 37.1 | 41.0 | 1.0 | 33.3 | 5.0 | 11.1 | 53.9 | 0.100 |
| +P6KE43 | 38.7 | 47.3 | 1.0 | 34.8 | 5.0 | 9.7 | 61.9 | 0.101 |
| +P6KE43A | 40.9 | 45.2 | 1.0 | 36.8 | 5.0 | 10.1 | 59.3 | 0.101 |
| +P6KE47 | 42.3 | 51.7 | 1.0 | 38.1 | 5.0 | 8.8 | 67.8 | 0.101 |
| +P6KE47A | 44.7 | 49.4 | 1.0 | 40.2 | 5.0 | 9.3 | 64.8 | 0.101 |
| P6KE51 | 45.9 | 56.1 | 1.0 | 41.3 | 5.0 | 8.2 | 73.5 | 0.102 |
| P6KE51A | 48.5 | 53.6 | 1.0 | 43.6 | 5.0 | 8.6 | 70.1 | 0.102 |
| P6KE56 | 50.4 | 61.6 | 1.0 | 45.4 | 5.0 | 7.5 | 80.5 | 0.103 |
| P6KE56A | 53.2 | 58.8 | 1.0 | 47.8 | 5.0 | 7.8 | 77.0 | 0.103 |
| P6KE62 | 55.8 | 68.2 | 1.0 | 50.2 | 5.0 | 6.7 | 89.0 | 0.104 |
| P6KE62A | 58.9 | 65.1 | 1.0 | 53.0 | 5.0 | 7.1 | 85.0 | 0.104 |
| P6KE68 | 61.2 | 74.8 | 1.0 | 55.1 | 5.0 | 6.1 | 98.0 | 0.104 |
| P6KE68A | 64.6 | 71.4 | 1.0 | 58.1 | 5.0 | 6.5 | 92.0 | 0.104 |
| P6KE75 | 67.5 | 82.5 | 1.0 | 60.7 | 5.0 | 5.6 | 108 | 0.105 |
| P6KE75A | 71.3 | 78.8 | 1.0 | 64.1 | 5.0 | 5.8 | 103 | 0.105 |
| P6KE82 | 73.8 | 90.2 | 1.0 | 66.4 | 5.0 | 5.1 | 118 | 0.105 |
| P6KE82A | 77.9 | 86.1 | 1.0 | 70.1 | 5.0 | 5.3 | 113 | 0.105 |
| P6KE91 | 81.9 | 100 | 1.0 | 73.7 | 5.0 | 4.6 | 131 | 0.106 |

+UL listed for Telecom application protection 497B, file number E136766 for both uni-directional and bi-directional devices

ELECTRICAL CHARACTERISTICS at (TA=25°C unless otherwise noted) TABLE (Cont'd)

| Device Type | Breakdown Voltage V _(BR) Volts (NOTE 1) | | Test Current at I _T (mA) | Stand-off Voltage V _{WM} (Volts) | Maximum Reverse Leakage at V _{WM} I _D (μA) (NOTE3) | Maximum Peak Pulse Current I _{PPM} (Amps) (NOTE 2) | Maximum Clamping Voltage at I _{PPM} V _C (Volts) | Maximum Temperature Coefficient of V _(BR) (% / C) |
|-------------|--|------|---|--|---|--|---|--|
| | MIN | MAX | | | | | | |
| P6KE91A | 86.5 | 95.5 | 1.0 | 77.8 | 5.0 | 4.8 | 125 | 0.106 |
| P6KE100 | 90.0 | 110 | 1.0 | 81.0 | 5.0 | 4.2 | 144 | 0.106 |
| P6KE100A | 95.0 | 105 | 1.0 | 85.5 | 5.0 | 4.4 | 137 | 0.106 |
| P6KE110 | 99.0 | 121 | 1.0 | 89.2 | 5.0 | 3.8 | 158 | 0.107 |
| P6KE110A | 105 | 116 | 1.0 | 94.0 | 5.0 | 3.9 | 152 | 0.107 |
| P6KE120 | 108 | 132 | 1.0 | 97.2 | 5.0 | 3.5 | 173 | 0.107 |
| P6KE120A | 114 | 126 | 1.0 | 102 | 5.0 | 3.6 | 165 | 0.107 |
| P6KE130 | 117 | 143 | 1.0 | 105 | 5.0 | 3.2 | 187 | 0.107 |
| P6KE130A | 124 | 137 | 1.0 | 111 | 5.0 | 3.4 | 179 | 0.107 |
| P6KE150 | 135 | 165 | 1.0 | 121 | 5.0 | 2.8 | 215 | 0.108 |
| P6KE150A | 143 | 158 | 1.0 | 128 | 5.0 | 2.9 | 207 | 0.108 |
| P6KE160 | 144 | 176 | 1.0 | 130 | 5.0 | 2.6 | 230 | 0.108 |
| P6KE160A | 152 | 168 | 1.0 | 136 | 5.0 | 2.7 | 219 | 0.108 |
| P6KE170 | 153 | 187 | 1.0 | 138 | 5.0 | 2.5 | 244 | 0.108 |
| P6KE170A | 162 | 179 | 1.0 | 145 | 5.0 | 2.6 | 234 | 0.108 |
| P6KE180 | 162 | 198 | 1.0 | 146 | 5.0 | 2.3 | 258 | 0.108 |
| P6KE180A | 171 | 189 | 1.0 | 154 | 5.0 | 2.4 | 246 | 0.108 |
| P6KE200 | 180 | 220 | 1.0 | 162 | 5.0 | 2.1 | 287 | 0.108 |
| P6KE200A | 190 | 210 | 1.0 | 171 | 5.0 | 2.2 | 274 | 0.108 |
| P6KE220 | 198 | 242 | 1.0 | 175 | 5.0 | 1.7 | 344 | 0.108 |
| P6KE220A | 209 | 231 | 1.0 | 185 | 5.0 | 1.8 | 328 | 0.108 |
| P6KE250 | 225 | 275 | 1.0 | 202 | 5.0 | 1.7 | 360 | 0.110 |
| P6KE250A | 237 | 263 | 1.0 | 214 | 5.0 | 1.7 | 344 | 0.110 |
| P6KE300 | 270 | 330 | 1.0 | 243 | 5.0 | 1.4 | 430 | 0.110 |
| P6KE300A | 285 | 315 | 1.0 | 256 | 5.0 | 1.4 | 414 | 0.110 |
| P6KE350 | 315 | 385 | 1.0 | 284 | 5.0 | 1.2 | 504 | 0.110 |
| P6KE350A | 333 | 368 | 1.0 | 300 | 5.0 | 1.2 | 482 | 0.110 |
| P6KE400 | 360 | 440 | 1.0 | 324 | 5.0 | 1.0 | 574 | 0.110 |
| P6KE400A | 380 | 420 | 1.0 | 342 | 5.0 | 1.1 | 548 | 0.110 |
| P6KE440 | 396 | 484 | 1.0 | 356 | 5.0 | 0.95 | 631 | 0.110 |
| P6KE440A | 418 | 462 | 1.0 | 376 | 5.0 | 1.0 | 602 | 0.110 |

NOTES:

- (1) V_(BR) measured after I_T applied for 300μs, I_T=square wave pulse or equivalent
 - (2) Surge current waveform per Fig. 3 and derate per Fig. 2
 - (3) For bidirectional types with V_{WM} of 10 volts and less, the I_D limit is doubled
 - (4) All terms and symbols are consistent with ANSI/IEEE C62.35
- +UL listed for Telecom application protection 497B, file number E136766 for both uni-directional and bi-directional devices

DESCRIPTION

This P6KE TVS series is a low cost commercial product for use in applications where large voltage transients can permanently damage voltage-sensitive components.

The P6KE series device types are designed in a small package size where power and space is a consideration. They are characterized by their high surge capability, extremely fast response time, and low impedance, (R_{ON}). Because of the unpredictable nature of transients, and the variation of the impedance with respect to these transients, impedance, per se, is not specified as a parametric value. However, a minimum voltage at low current conditions (BV) and a maximum clamping voltage (Vc) at a maximum peak pulse current is specified.

In some instances, the thermal effect (see Vc Clamping Voltage) may be responsible for 50% to 70% of the observed voltage differential when subjected to high current pulses for several duty cycles, thus making a maximum impedance specification insignificant. In case of a severe current overload or abnormal transient beyond the maximum ratings, the Transient Voltage Suppressor will initially fail 'short' thus tripping the system's circuit breaker or fuse while protecting the entire circuit. Curves depicting clamping voltage vs. various current pulses are available from the factory. Extended power curves vs. pulse time are also available.

RATINGS AND CHARACTERISTIC CURVES P6KE6.8 THRU P6KE440CA

FIG. 1 - PEAK PULSE POWER RATING CURVE

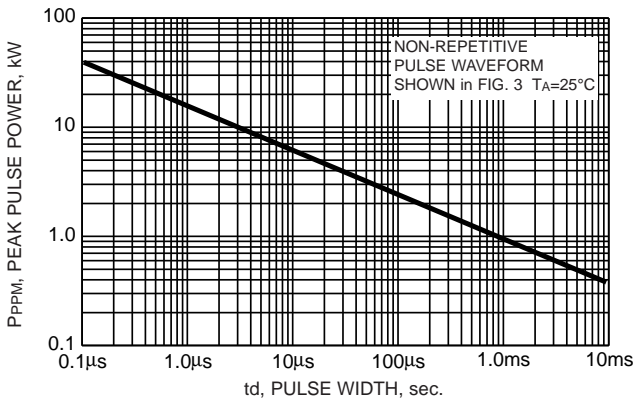

FIG. 2 - PULSE DERATING CURVE

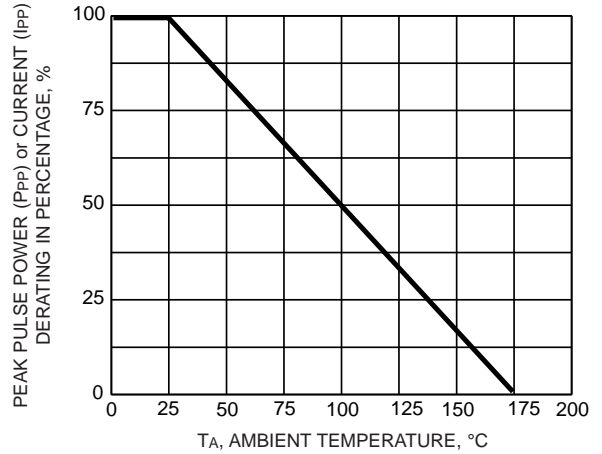

FIG. 3 - PULSE WAVEFORM

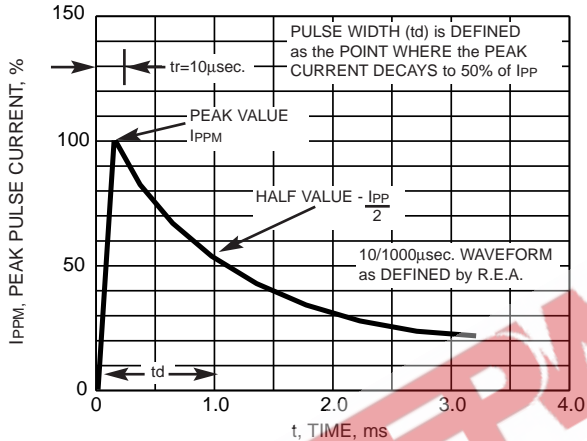

FIG. 4 - TYPICAL JUNCTION CAPACITANCE UNIDIRECTIONAL

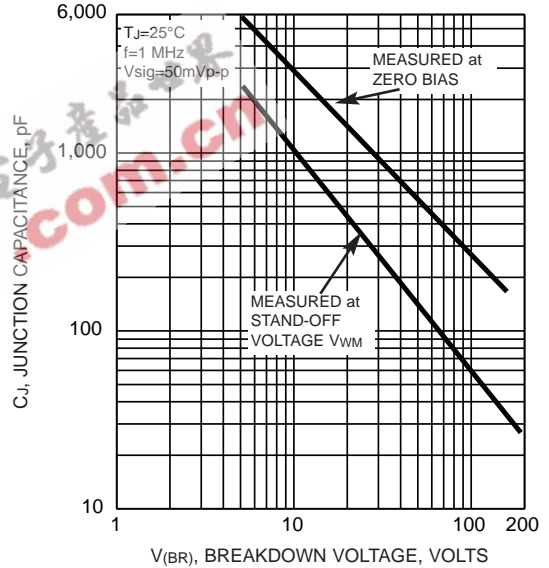

FIG. 5 - STEADY STATE POWER DERATING CURVE

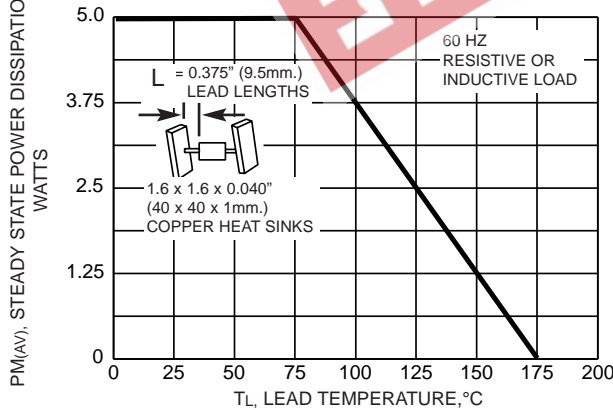

FIG. 6 - MAXIMUM NON-REPETITIVE FORWARD SURGE CURRENT UNI-DIRECTIONAL

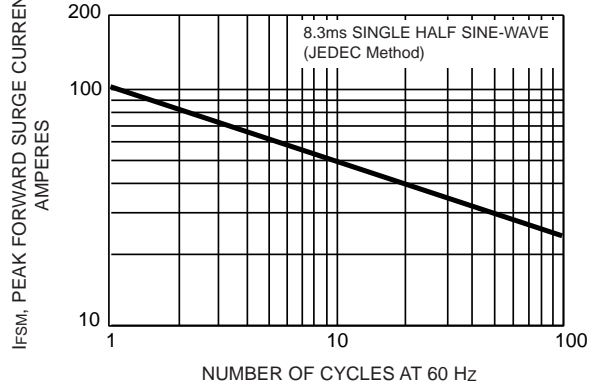

FIG. 7 - TYPICAL REVERSE LEAKAGE CHARACTERISTICS

