

C&K RTE Series Low Profile Rotary DIP Switches

DIP

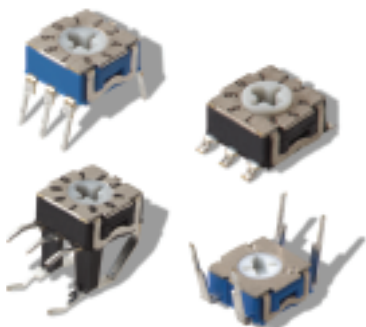

Features/Benefits

- Thru-hole and surface mount models
- Miniature size with robust stainless steel cover
- Rotary SPDT, SP3T, SP4T functions
- Rotary binary-decimal and hexadecimal coding
- RoHS compliant - options available

Typical Applications

- Timers, automation components
- Computer and peripherals
- Alarms, access control
- Instrumentation

Specifications

CONTACT RATING:
Gold: 100 mA max. 10 μ A min. 30 V DC max. 20 mVDC min.
Silver: 100 mA max. 1 mA min. 50 V DC max. 2 VDC min.

MECHANICAL LIFE: RTE02/03: 1,500 actuations; RTE04/10/16: 20,000 actuations

CONTACT RESISTANCE: 100 m Ω max. initial;
150 m Ω after life

INSULATION RESISTANCE: RTE02/03: 10¹³ Ω min.
RTE04/10/16: 10¹⁰ Ω min. initial

DIELECTRIC STRENGTH: RTE 02/03: 500 Vrms;
RTE 10/16; 300 Vrms

OPERATING TEMPERATURE: -25°C to 85°C.
STORAGE TEMPERATURE: -40°C to 85°C.

PACKAGING: N or R terminations in tube.
V termination in box. G termination in reel, 750 pieces per reel. G termination with flush actuator, 1250 pieces per reel.

Materials

COVER & BASE: Thermoplastic PPS
ACTUATOR: PA Thermoplastic
KNOB: Thermoplastic
MOVABLE CONTACTS: Brass, gold or silver plated.
STATIONARY CONTACTS: Brass, gold or silver plated.
TERMINALS: See page I-24
O-RING: Silicone

NOTE: For the latest information regarding RoHS compliance, please go to: www.ittcannon.com/rohs.

Note: Specifications and materials listed above are for switches with standard options. For information on specific and custom switches, consult Customer Service Center.

Solderability: Wave soldering 260°/2s.

SMT are reflow compatible according to CECC 00802-NORM.

How To Order

Our easy Build-A Switch concept allows you to mix and match options to create the switch you need. Below is a complete listing of options shown in catalog. To order, simply select desired option from each category and place in the appropriate box.

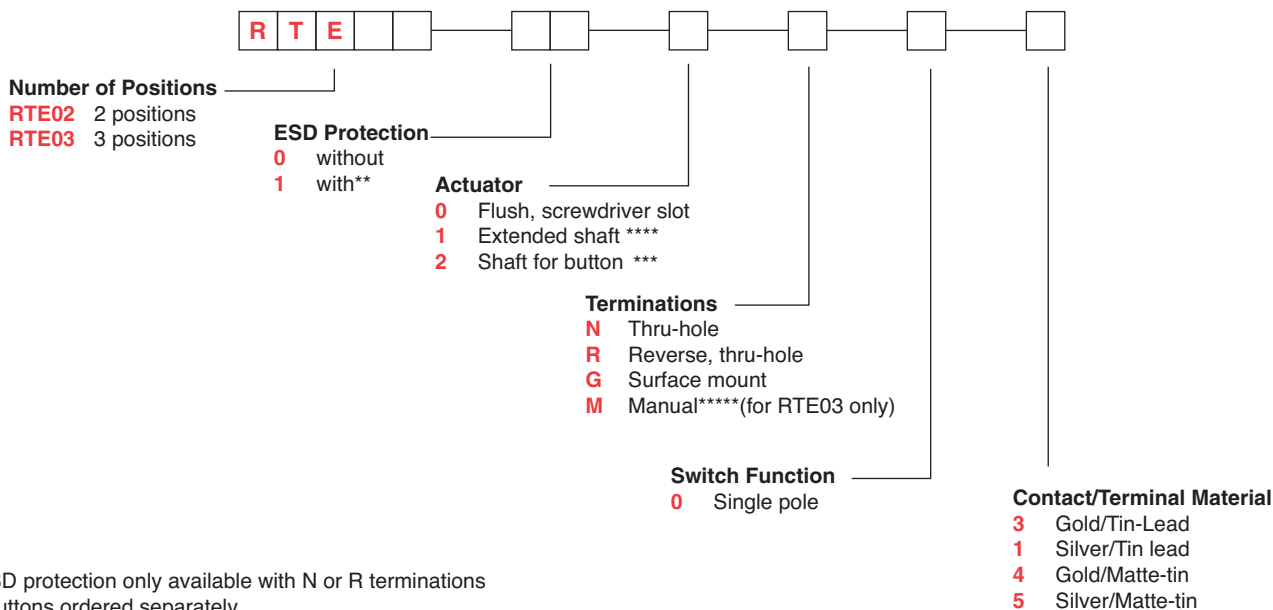

** ESD protection only available with N or R terminations
 *** Buttons ordered separately
 **** Not available in surface mount.
 ***** Only possible in combination with actuator option "2"



C&K RTE Series Low Profile Rotary DIP Switches



—

DIP

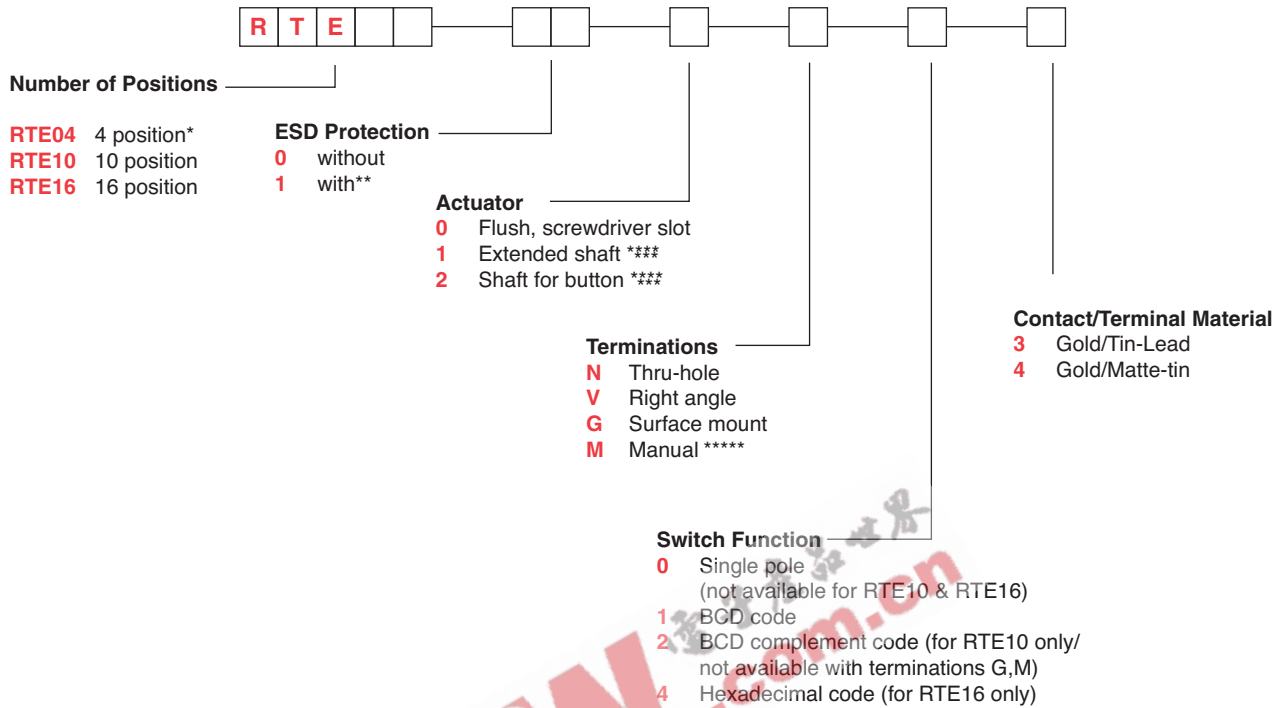

* RTE04 version only available with screw driver slot acuator "0"
 ** ESD protection only available with N termination
 *** Buttons ordered separately
 **** Not available in surface mount
 ***** Available with RTE 10, and RTE 16, with actuator option 2 only

Please note Gray code option available, consult ITT customer service for options and availability.



Dimensions are shown: Inch (mm)
 Specifications and dimensions subject to change

C&K RTE Series Low Profile Rotary DIP Switches

SWITCHES WITH STANDARD OPTIONS

PC Mount

PART NUMBER WITHOUT ESD PIN	WITH ESD PIN	NO. POS.	FUNCTION	QTY PER TUBE
RTE0200N03	RTE0210N03	2	SPDT	65
RTE0300N03	RTE0310N03	3	SP3T	65
RTE0400N03	RTE0400N03	4	SP4T	65
RTE1000N13	RTE1010N13	10	BCD	65
RTE1600N43	RTE1610N43	10	HEXADECIMAL	65

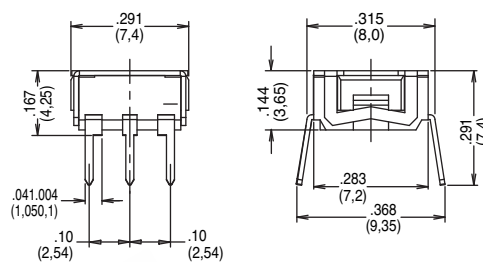

Right Angle Mount

PART NUMBER	NO. POS.	FUNCTION	QUANTITY
RTE0400V03	4	SP4T	150 per box
RTE1000V13	10	BCD	150 per box
RTE1600V43	16	HEXADECIMAL	150 per box

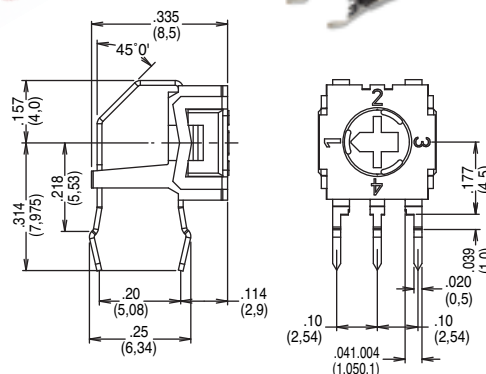

Surface Mount

PART NUMBER	NO. POS.	FUNCTION	QUANTITY PER REEL
RTE0200G03	02	SPDT	1250
RTE0300G03	03	SPDT	1250
RTE0400G03	04	SP4T	1250
RTE1000G13	10	BCD	1250
RTE1600G43	16	HEXADECIMAL	1250

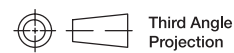
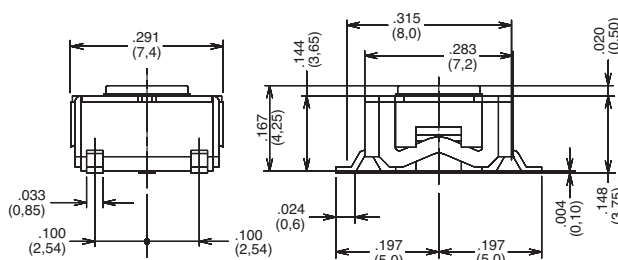

Dimensions are shown: Inch (mm)
Specifications and dimensions subject to change

C&K RTE Series Low Profile Rotary DIP Switches

NUMBER OF POSITIONS

RTE02* 2 POSITION

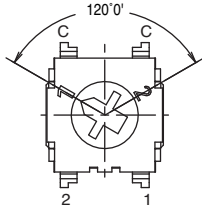

RTE03* 3 POSITION

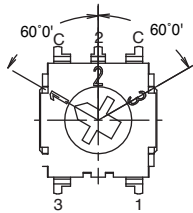

RTE04 4 POSITION

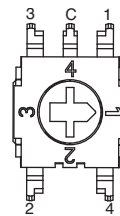

RTE10 10 POSITION

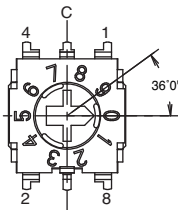

RTE16 16 POSITION

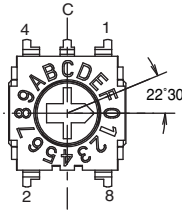

ESD PROTECTION

0 WITHOUT

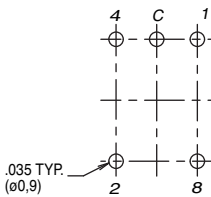
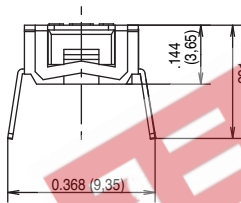
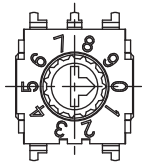

1 WITH

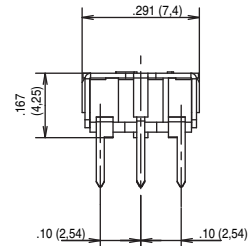
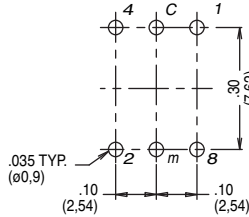
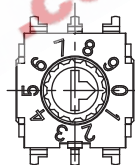

ACTUATOR

0 FLUSH, SCREWDRIVER SLOT

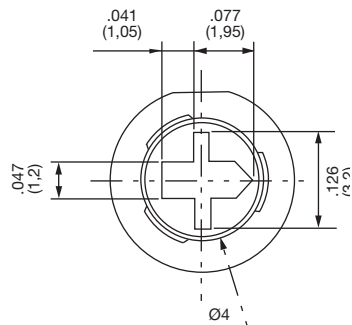

1 EXTENDED SHAFT
(not available in surface mount)

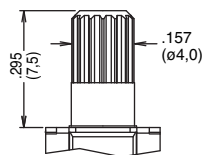

2 SHAFT FOR BUTTON

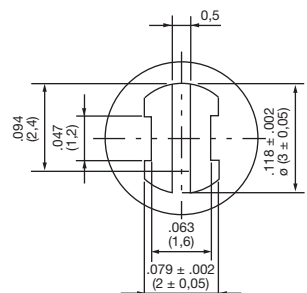
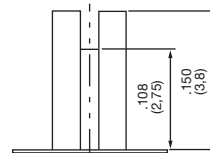

Dimensions are shown: Inch (mm)
Specifications and dimensions subject to change

C&K RTE Series Low Profile Rotary DIP Switches

DIP

SWITCH FUNCTION

0 SINGLE POLE

POS.	1	2	3	4
C	●	●	●	●
1	●			
2		●		
3			●	
4				●

1 BCD CODE

POS.	0	1	2	3	4	5	6	7	8	9
C	●	●	●	●	●	●	●	●	●	●
1		●		●		●		●		●
2			●	●		●		●		●
4				●	●	●		●		●
8								●	●	●

2 BCD COMPLEMENT CODE

POS.	0	1	2	3	4	5	6	7	8	9
C	●	●	●	●	●	●	●	●	●	●
1	●			●		●		●		●
2		●			●		●		●	
4	●	●	●	●					●	●
8	●	●	●	●	●	●	●	●		

Other codes available by request.

4 HEXADECIMAL CODE

POS.	0	1	2	3	4	5	6	7	8	9	10	11	12	13	14	15
C	●	●	●	●	●	●	●	●	●	●	●	●	●	●	●	●
1		●		●		●		●		●		●		●		●
2			●	●		●	●			●	●			●	●	
4					●	●	●			●	●			●	●	
8								●	●	●	●	●	●	●	●	●

CONTACT MATERIAL

OPTION CODE	RoHS COMPLIANT *	RoHS COMPATIBLE *	CONTACT MATERIAL	TERMINAL PLATING	RATINGS		
3	NO	**	GOLD	TIN LEAD	100 mA max.	10μ A min.	30 V DC max.
1	NO	**	SILVER	TIN LEAD	100 mA max.	1 mA min.	50 V DC max.
*4	YES	**	GOLD	MATTE TIN	100 mA max.	10μ A min.	30 V DC max.
*5	YES	**	SILVER	MATTE TIN	100 mA max.	1 mA min.	50 V DC max.

* Note: See Technical Data section of this catalog for RoHS compliant and compatible definitions and specifications.

** When selecting contact material option 4 and 5 with RTE02, RTE03 and or "V" terminations, these combinations are RoHS compliant but not compatible (i.e. they do not sustain the high temperatures of the leadfree soldering process). All other options and terminations are RoHS compatible. (Compliant with 4 and 5 contact material only).

BUTTONS AVAILABLE

Buttons are ordered separately, shipped in bulk.

Part Number Color

BTN RTE 40	Red
BTN RTE 50	Green
BTN RTE 90	Black

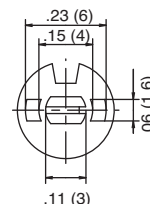
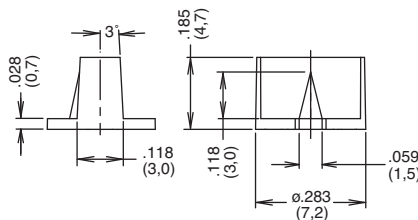

Third Angle Projection

Dimensions are shown: Inch (mm)
Specifications and dimensions subject to change



C&K RTE Series Low Profile Rotary DIP Switches

TAPE AND REEL



—

DIP

Tape and reel for RTExx02Gxx
750 pieces per reel.

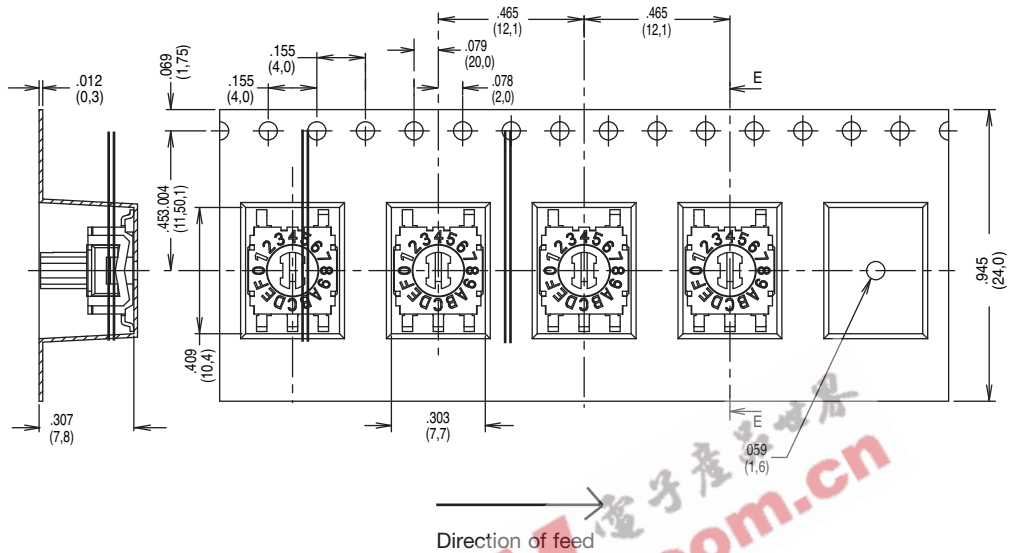

Tape and reel for RTExx00Gxx
1,250 pieces per reel.

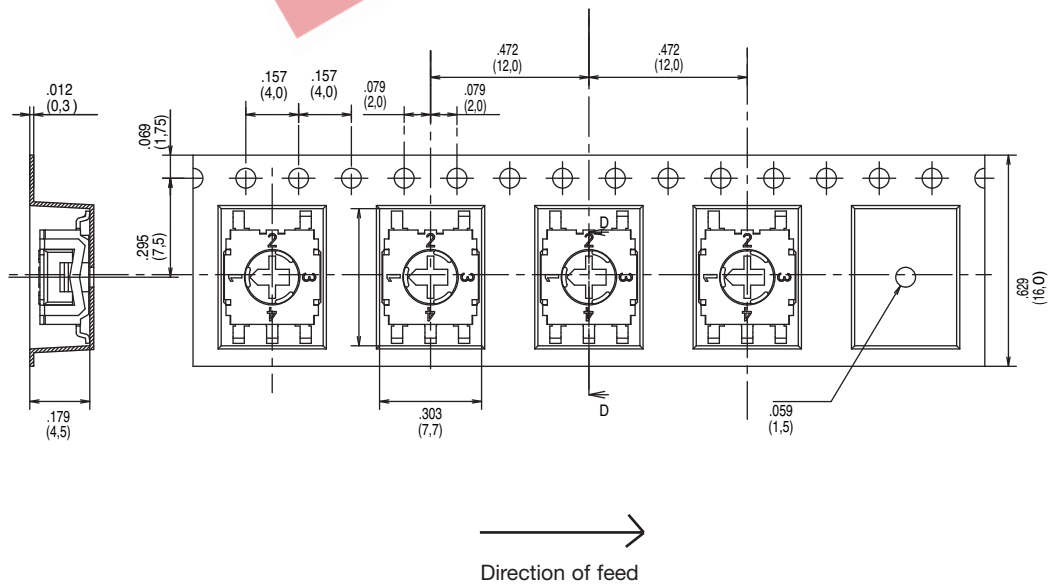

Note: Dimensions in: $\frac{\text{inches}}{\text{(mm)}}$

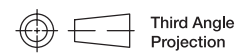

Dimensions are shown: Inch (mm)
Specifications and dimensions subject to change

