

RV4140A

Low Power Two-Wire Ground Fault Interrupter Controller

Features

- Powered from the AC line
- Built-in bridge rectifier
- Direct interface to SCR
- 350 μ A quiescent current
- Adjustable trip current
- Adjustable time delay
- Minimum external components
- Meets UL 943 requirements
- Specifically for two-wire systems
- For use with 110V or 220V systems

Description

The RV4140A is a low power controller for AC outlet appliance leakage circuit interrupters. These devices detect hazardous current paths to ground such as an appliance falling into water. The interrupter then open circuits the line before a harmful or lethal shock occurs.

Internally, the RV4140A has a diode bridge rectifier, zener shunt regulator, op amp, current reference, time delay circuit, latch and SCR driver.

An external sense transformer, SCR, relay, two resistors and three capacitors complete the design of the circuit interrupter. The simple layout and minimum component count ensure ease of application and long term reliability.

Block Diagram

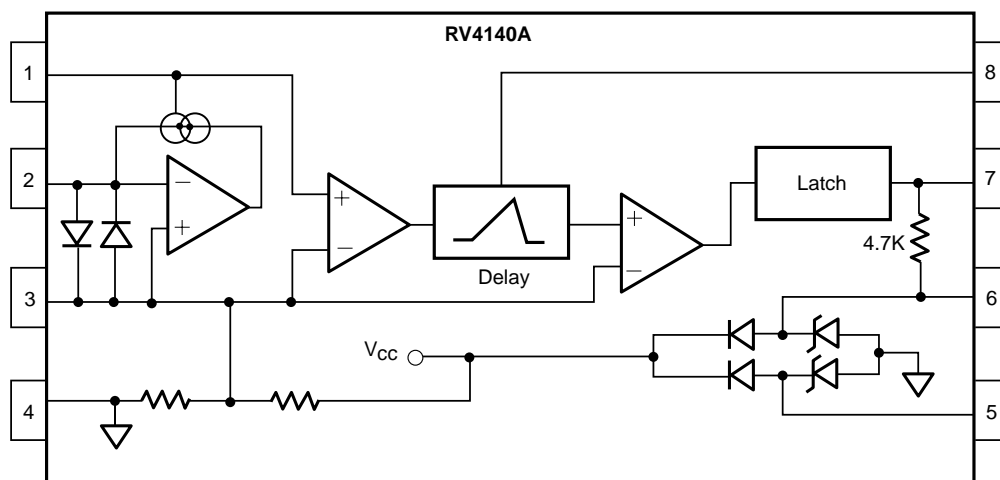

65-4140A-01

Functional Description

(Refer to Block Diagram and Figure 1)

The shunt regulator generated by a 6.5V zener diode is built into the internal bridge rectifier. It is divided to create an internal reference voltage of 2.9V connected to pin 3. The secondary of the sense transformer is AC coupled to the inverting input of the sense amplifier at pin 2; the non-inverting input is referenced to pin 3. A current feedback loop around the sense amplifier ensures a virtual ground will be presented to the secondary of the sense transformer. In this manner it acts as a current transformer instead of a voltage transformer. In this mode, the transformer's characteristics are very predictable and circuit adjustments are not necessary in production.

The sense transformer has a toroidal core made of laminated steel rings or solid ferrite material. The secondary of the transformer is 500 to 1000 turns of #40 wire wound through the toroid. The primary's one turn made by passing the AC hot and neutral wires through the center of the toroid. When a ground fault exists, a difference exists between the current flowing in hot and neutral wires. The difference primary current, divided by the number of secondary turns, flows through the secondary wire of the transformer.

The AC coupled transformer secondary current then flows through the sense amplifier's feedback loop, creating a full wave rectified version of the secondary fault current. This current passes through RSET at pin 1, generating a voltage equal to RSET times the peak fault current divided by the sense transformer turns ratio. This voltage is compared with the reference voltage at pin 3.

If the voltage at pin 1 is greater than pin 3, a comparator will charge C2 through a 29 μ A current source at pin 8. If the voltage at pin 1 exceeds pin 3 for longer than the delay time, a 400 μ A current will pulse between pins 7 and 6 which will trigger the gate of the SCR.

If the voltage at pin 1 exceeds pin 3 for less than the delay time, the SCR will not trigger.

The fault current at which the controller triggers the SCR is dependent on the value of RSET and the time delay determined by C2.

UL 943 requires the circuit interrupter trip when the ground fault exceeds 6 mA and not trip when the fault current is less than 4 mA.

Supply Current Requirements

The RV4140A has a built-in diode bridge rectifier that provides power to the chip independent of the polarity of the AC line. This eliminates the external rectifier required for previous GFCI controllers.

R_{LINE} limits the shunt regulator current to 2 mA. The recommended value is 47K to 91K for 110V systems and 91K to 150K for 220V systems. The recommended maximum peak line current through R_{LINE} is 7 mA.

DO NOT connect a filter capacitor between pins 5 and 6 in an attempt to filter the supply voltage at the RV4140A. Proper operation of the RV4140A requires the internal supply voltage to be unfiltered.

SCR Driver

The SCR must have a high dV/dt rating to ensure that line noise (generated by electrically noisy appliances) does not falsely trigger the SCR. Also, the SCR must have a gate drive requirement less than 200 μ A. C3 is a noise filter that prevents high frequency line pulses from triggering the SCR.

The relay solenoid used should have a 3 ms or less response time to meet the UL 943 timing requirement.

Supplier of Sense Transformers and Cores

Magnetic Metals Corporation, Camden, NJ 08101, (609) 964-7842, supplies a full line of ring cores and transformers designed specifically for GFCI and related applications.

Determining the Values of RSET and C2

Determine the ground fault trip current requirement. This will be typically 5 mA in North America (117 VAC) and 10 mA in the UK and Europe.

Determine the minimum amount of time delay required to prevent nuisance tripping. This will typically be 1 to 2 ms.

The value of C2 required to provide the desired delay time is:

$$C2 = 10 \times T$$

where C2 is in nF, and T is the desired delay time in ms.

The value of R_{SET} to meet nominal ground fault trip current specification is:

$$R_{SET} = \frac{2.05 \times N}{I_{FAULT} \times \cos 180(T/P)}$$

Where:

- R_{SET} is in $k\Omega$
- T is the time delay in ms
- P is the period of the line frequency in ms
- I_{FAULT} is the desired ground fault trip current in mA RMS.
- N is the number of sense transformer secondary turns.

This formula assumes an ideal sense transformer is used. The calculated value of R_{SET} may have to be changed up to 30% when using a non-ideal transformer.

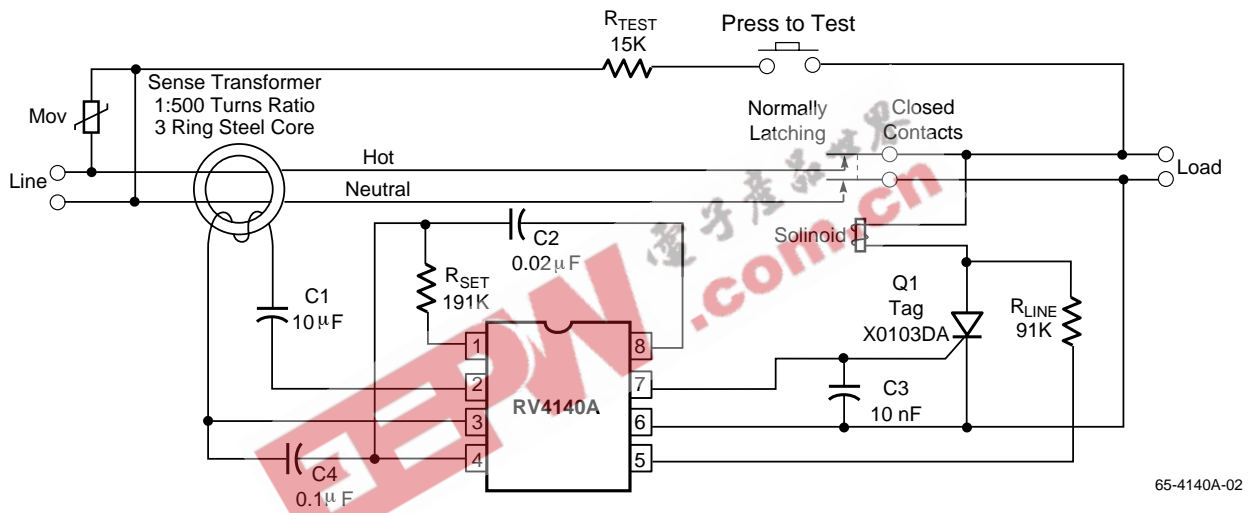

65-4140A-02

Figure 1. Appliance Leakage Detector Circuit Application

Pin Assignments

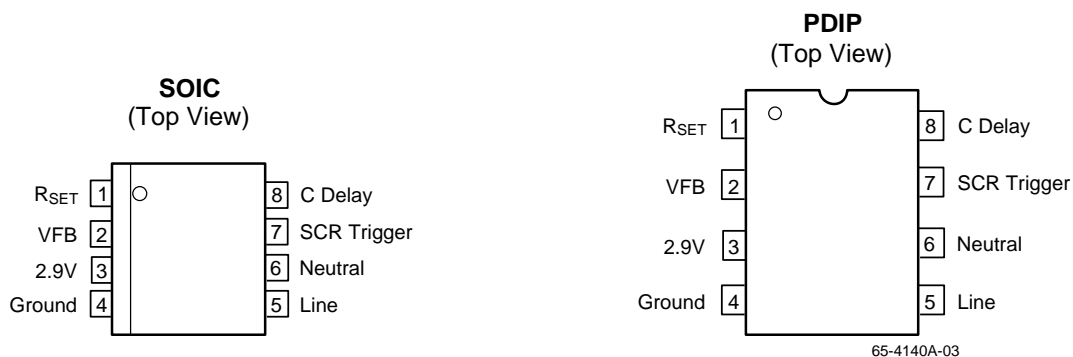

Absolute Maximum Ratings

Parameter	Min.	Typ.	Max.	Units
Supply Current			7	mA
Internal Power Dissipation			500	mW
Storage Temperature Range	-65		+150	°C
Operating Temperature Range	-35		+80	°C
Lead Soldering Temperature	60 Seconds, DIP		+300	°C
	10 Seconds, SOIC		+260	°C

Thermal Characteristics

Parameter	8 Lead Plastic SOIC	8 Lead Plastic DIP
Maximum Junction Temperature	+125°C	+125°C
Maximum P _{DTA<50°C}	300 mW	468 mW
Thermal Resistance, θ_{JA}	240°C/W	160°C/W
For T _A > 50°C Derate at	4.1 mW/°C	6.25 mW/°C

Electrical Characteristics

$I_{LINE} = 1.2\text{mA}$ and $T_A = +25^\circ\text{C}$, $R_{SET} = 290\text{k}\Omega$

Parameters	Test Conditions	Min.	Typ.	Max.	Units
Shunt Regulator (Pins 5 to 4)					
Regulated Voltage	$I_{2-3} = 11\mu\text{A}$	6.8	7.2	7.6	V
Regulated Voltage	$I_{LINE} = 700\mu\text{A}$, $I_{2-3} = 9\mu\text{A}$	6.8	7.2	7.6	V
Sense Amplifier (Pins 2 to 3)					
Offset Voltage	Design Value	-3.0	0	3.0	mV
Gain Bandwidth	Design Value		2.0		MHz
Input Bias Current	Design Value		30	100	nA
SCR Trigger (Pins 7 to 6)					
Output Resistance	$V_{5-6} = \text{open}$, $I_{2-3} = 0\mu\text{A}$	4.0	4.7	5.4	$\text{k}\Omega$
Output Voltage	$I_{2-3} = 9\mu\text{A}$	0	0.1	10	mV
Output Voltage	$I_{2-3} = 11\mu\text{A}$	1.4	2.0	2.6	V
Output Current	$V_{7-6} = 0\text{V}$, $I_{2-3} = 11\mu\text{A}$	300	420	600	μA
Reference Voltage (Pins 3 to 4)					
Reference Voltage	$I_{LINE} = 700\mu\text{A}$	2.6	2.9	3.2	V
Delay Timer (Pins 8 to 4)					
Delay Time ¹	$C_{8-4} = 20\text{nF}$	—	2.0	—	ms
Delay Current	$I_{2-3} = 11\mu\text{A}$	23	29	35	μA

Note:

1. Delay time is defined as starting when the instantaneous sense current (I_{2-3}) exceeds $2.9\text{V}/R_{SET}$ and ending when the SCR trigger voltage V_{7-6} goes high.

Schematic Diagram

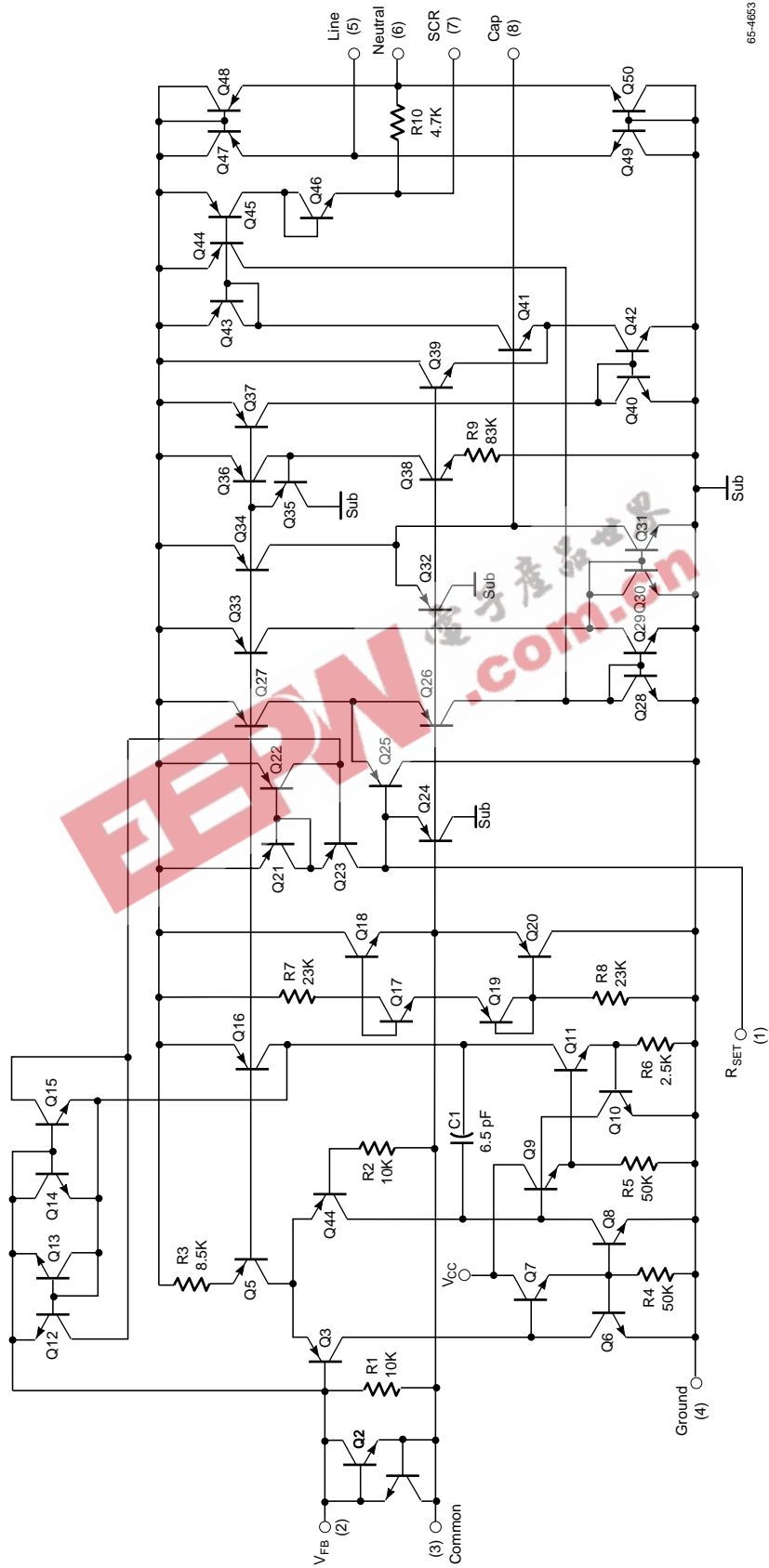

65-4653

Notes:

EEPW 电子产品世界
.com.cn

Notes:



Notes:

EEPW 电子产品世界
.com.cn

Mechanical Dimensions

8-Lead Plastic DIP Package

Symbol	Inches		Millimeters		Notes
	Min.	Max.	Min.	Max.	
A	—	.210	—	5.33	
A1	.015	—	.38	—	
A2	.115	.195	2.93	4.95	
B	.014	.022	.36	.56	
B1	.045	.070	1.14	1.78	
C	.008	.015	.20	.38	4
D	.348	.430	8.84	10.92	2
D1	.005	—	.13	—	
E	.300	.325	7.62	8.26	
E1	.240	.280	6.10	7.11	2
e	.100 BSC		2.54 BSC		
eB	—	.430	—	10.92	
L	.115	.160	2.92	4.06	
N	8°		8°		5

Notes:

1. Dimensioning and tolerancing per ANSI Y14.5M-1982.
2. "D" and "E1" do not include mold flashing. Mold flash or protrusions shall not exceed .010 inch (0.25mm).
3. Terminal numbers are for reference only.
4. "C" dimension does not include solder finish thickness.
5. Symbol "N" is the maximum number of terminals.

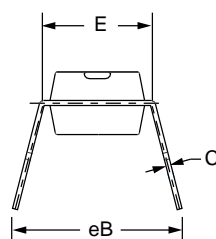
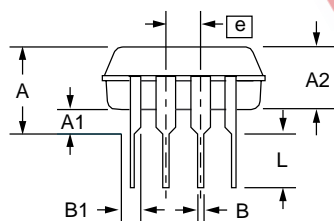
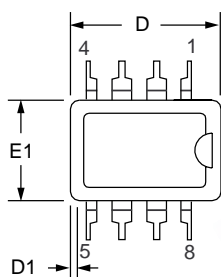

Mechanical Dimensions (continued)

8-Lead SOIC Package

Symbol	Inches		Millimeters		Notes
	Min.	Max.	Min.	Max.	
A	.053	.069	1.35	1.75	
A1	.004	.010	0.10	0.25	
B	.013	.020	0.33	0.51	
C	.008	.010	0.20	0.25	5
D	.189	.197	4.80	5.00	2
E	.150	.158	3.81	4.01	2
e	.050 BSC		1.27 BSC		
H	.228	.244	5.79	6.20	
h	.010	.020	0.25	0.50	
L	.016	.050	0.40	1.27	3
N	8		8		6
α	0°	8°	0°	8°	
ccc	—	.004	—	0.10	

Notes:

1. Dimensioning and tolerancing per ANSI Y14.5M-1982.
2. "D" and "E" do not include mold flash. Mold flash or protrusions shall not exceed .010 inch (0.25mm).
3. "L" is the length of terminal for soldering to a substrate.
4. Terminal numbers are shown for reference only.
5. "C" dimension does not include solder finish thickness.
6. Symbol "N" is the maximum number of terminals.

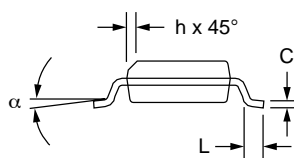
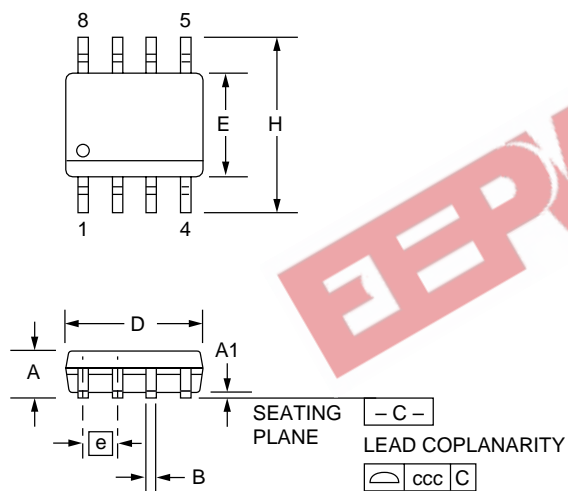

Ordering Information

Part Number	Package	Operating Temperature Range
RV4140AN	8-Lead Plastic DIP	-35°C to +80°C
RV4140AM	8-Lead Plastic SOIC	-35°C to +80°C

EEPW 电子产品世界
.com.cn

LIFE SUPPORT POLICY

FAIRCHILD'S PRODUCTS ARE NOT AUTHORIZED FOR USE AS CRITICAL COMPONENTS IN LIFE SUPPORT DEVICES OR SYSTEMS WITHOUT THE EXPRESS WRITTEN APPROVAL OF THE PRESIDENT OF FAIRCHILD SEMICONDUCTOR CORPORATION. As used herein:

1. Life support devices or systems are devices or systems which, (a) are intended for surgical implant into the body, or (b) support or sustain life, and (c) whose failure to perform when properly used in accordance with instructions for use provided in the labeling, can be reasonably expected to result in a significant injury of the user.
2. A critical component in any component of a life support device or system whose failure to perform can be reasonably expected to cause the failure of the life support device or system, or to affect its safety or effectiveness.