

**50A, 600V Ultrafast Diode**

The RURU5060 is an ultrafast diode with soft recovery characteristics ( $t_{rr} < 65ns$ ). It has low forward voltage drop and is of silicon nitride passivated ion-implanted epitaxial planar construction.

This device is intended for use as a freewheeling/clamping diode and rectifier in a variety of switching power supplies and other power switching applications. Its low stored charge and ultrafast recovery with soft recovery characteristic minimizes ringing and electrical noise in many power switching circuits reducing power loss in the switching transistors.

Formerly development type TA9909.

**Ordering Information**

PART NUMBER	PACKAGE	BRAND
RURU5060	TO-218	RURU5060

NOTE: When ordering, use the entire part number.

**Symbol**



**Features**

- Ultrafast with Soft Recovery . . . . . <65ns
- Operating Temperature. . . . . 175°C
- Reverse Voltage . . . . . 600V
- Avalanche Energy Rated
- Planar Construction

**Applications**

- Switching Power Supplies
- Power Switching Circuits
- General Purpose

**Packaging**

JEDEC STYLE SINGLE LEAD TO-218

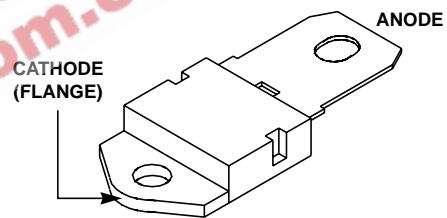

**Absolute Maximum Ratings**  $T_C = 25^{\circ}C$ , Unless Otherwise Specified

	RURU5060	UNITS
Peak Repetitive Reverse Voltage . . . . . $V_{RRM}$	600	V
Working Peak Reverse Voltage . . . . . $V_{RWM}$	600	V
DC Blocking Voltage . . . . . $V_R$	600	V
Average Rectified Forward Current . . . . . $I_{F(AV)}$ ( $T_C = 102^{\circ}C$ )	50	A
Repetitive Peak Surge Current . . . . . $I_{FRM}$ (Square Wave, 20kHz)	100	A
Nonrepetitive Peak Surge Current . . . . . $I_{FSM}$ (Halfwave, 1 Phase, 60Hz)	500	A
Maximum Power Dissipation . . . . . $P_D$	150	W
Avalanche Energy (See Figures 7 and 8) . . . . . $E_{AVL}$	40	mJ
Operating and Storage Temperature . . . . . $T_{STG}, T_J$	-65 to 175	°C

## RURU5060

### Electrical Specifications $T_C = 25^\circ\text{C}$ , Unless Otherwise Specified

SYMBOL	TEST CONDITION	MIN	TYP	MAX	UNITS
$V_F$	$I_F = 50\text{A}$	-	-	1.6	V
	$I_F = 50\text{A}, T_C = 150^\circ\text{C}$	-	-	1.4	V
$I_R$	$V_R = 600\text{V}$	-	-	250	$\mu\text{A}$
	$V_R = 600\text{V}, T_C = 150^\circ\text{C}$	-	-	1.5	mA
$t_{rr}$	$I_F = 1\text{A}, dI_F/dt = 100\text{A}/\mu\text{s}$	-	-	65	ns
	$I_F = 50\text{A}, dI_F/dt = 100\text{A}/\mu\text{s}$	-	-	75	ns
$t_a$	$I_F = 50\text{A}, dI_F/dt = 100\text{A}/\mu\text{s}$	-	30	-	ns
$t_b$	$I_F = 50\text{A}, dI_F/dt = 100\text{A}/\mu\text{s}$	-	20	-	ns
$R_{\theta JC}$		-	-	1	$^\circ\text{C}/\text{W}$

#### DEFINITIONS

$V_F$  = Instantaneous forward voltage (pw = 300 $\mu\text{s}$ , D = 2%).

$I_R$  = Instantaneous reverse current.

$t_{rr}$  = Reverse recovery time (See Figure 6), summation of  $t_a + t_b$ .

$t_a$  = Time to reach peak reverse current (See Figure 6).

$t_b$  = Time from peak  $I_{RM}$  to projected zero crossing of  $I_{RM}$  based on a straight line from peak  $I_{RM}$  through 25% of  $I_{RM}$  (See Figure 6).

$R_{\theta JC}$  = Thermal resistance junction to case.

pw = Pulse width.

D = Duty cycle.

### Typical Performance Curves

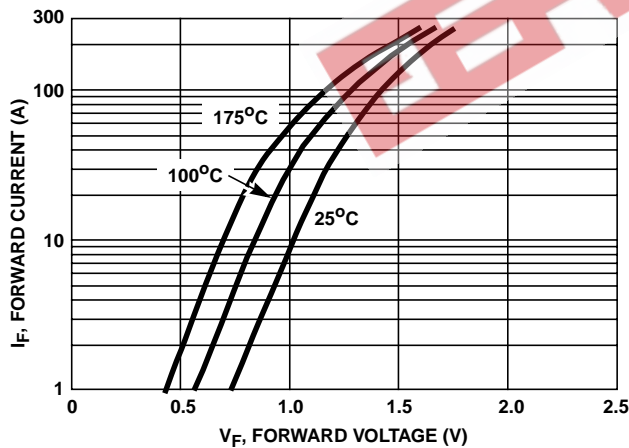

FIGURE 1. FORWARD CURRENT vs FORWARD VOLTAGE

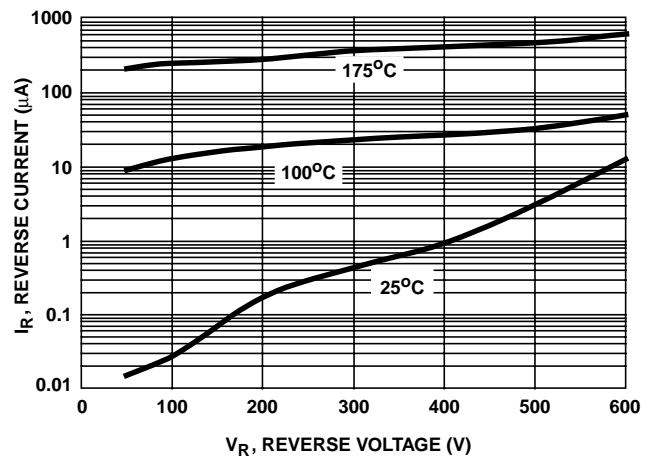

FIGURE 2. REVERSE CURRENT vs REVERSE VOLTAGE

Typical Performance Curves (Continued)

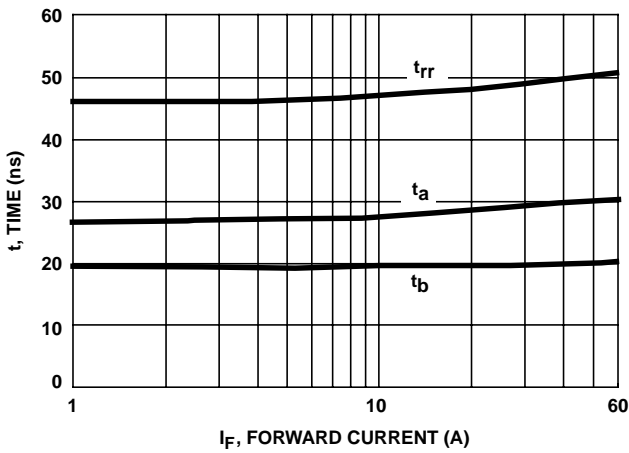

FIGURE 3.  $t_{rr}$ ,  $t_a$  AND  $t_b$  CURVES vs FORWARD CURRENT

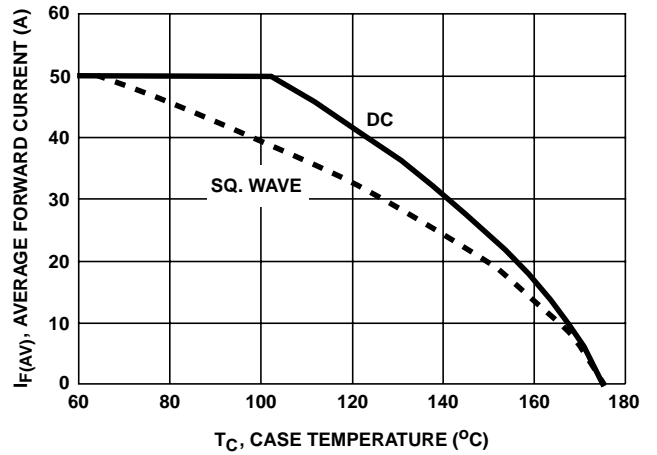

FIGURE 4. CURRENT DERATING CURVE

Test Circuits and Waveforms

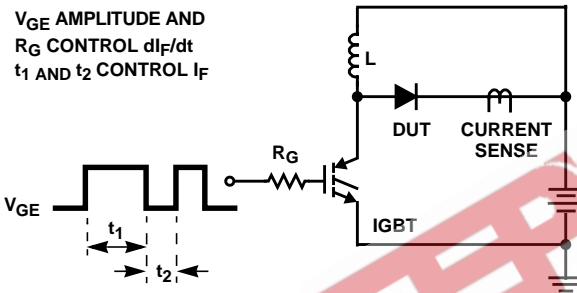

FIGURE 5.  $t_{rr}$  TEST CIRCUIT

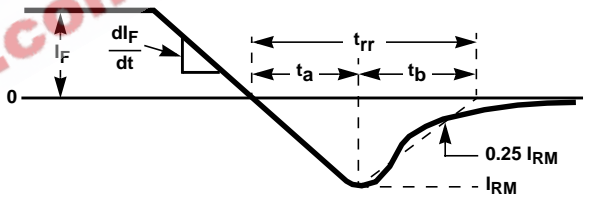

FIGURE 6.  $t_{rr}$  WAVEFORMS AND DEFINITIONS

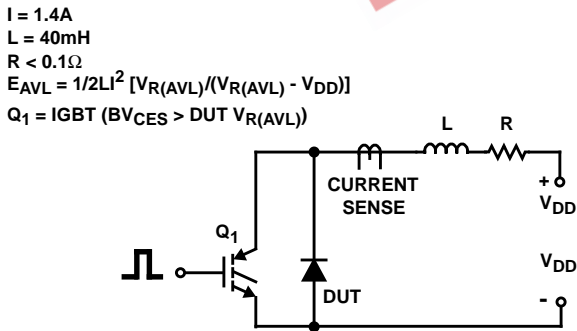

FIGURE 7. AVALANCHE ENERGY TEST CIRCUIT

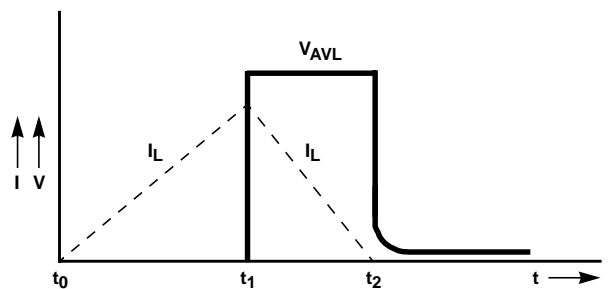

FIGURE 8. AVALANCHE CURRENT AND VOLTAGE WAVEFORMS

All Intersil semiconductor products are manufactured, assembled and tested under ISO9000 quality systems certification.

Intersil semiconductor products are sold by description only. Intersil Corporation reserves the right to make changes in circuit design and/or specifications at any time without notice. Accordingly, the reader is cautioned to verify that data sheets are current before placing orders. Information furnished by Intersil is believed to be accurate and reliable. However, no responsibility is assumed by Intersil or its subsidiaries for its use; nor for any infringements of patents or other rights of third parties which may result from its use. No license is granted by implication or otherwise under any patent or patent rights of Intersil or its subsidiaries.

For information regarding Intersil Corporation and its products, see web site [www.intersil.com](http://www.intersil.com)