

TELEDYNE RELAYS

SERIES S114

CENTIGRID® SURFACE MOUNT AEROSPACE RELAY DPDT

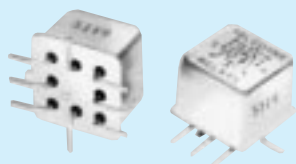

SERIES DESIGNATION	RELAY TYPE
S114	DPDT basic relay
S114D	DPDT relay with internal diode for coil suppression
S114DD	DPDT relay with internal diodes for coil transient suppression and polarity reversal protection

INTERNAL CONSTRUCTION

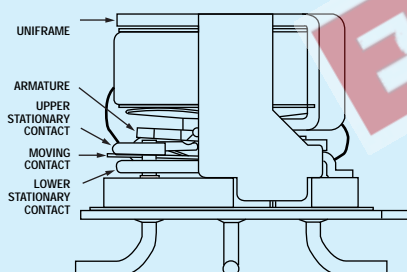

DESCRIPTION

The S114 Series Surface Mount Centigridd® Relay is an ultraminiature, hermetically sealed, armature relay. The low profile height (.360") and .100" lead spacing make it ideal for applications where extreme packaging density and/or close PC board spacing are required. The specially formed leads are pre-tinned to make the relays ideal for most types of surface mount solder reflow processes.

The basic design and internal construction are identical to the 114 Series Centigridd® relays, and are capable of meeting Teledyne Relays **T²R**® requirements. The following unique construction features and manufacturing techniques provide overall high reliability and excellent resistance to environmental extremes:

- All welded construction.
- Unique uni-frame design providing high magnetic efficiency and mechanical rigidity.
- High force/mass ratios for resistance to shock and vibration.
- Advanced cleaning techniques provide maximum assurance of internal cleanliness.
- Precious metal alloy contact material with gold plating assures excellent high current and dry circuit switching capabilities.

The S114D and S114DD Series utilize internal discrete silicon diodes for coil suppression and polarity reversal protection.

By virtue of its inherently low intercontact capacitance and contact circuit losses, the S114 relay has shown itself to be an excellent ultraminiature RF switch for frequency ranges well into the UHF spectrum. A typical RF application for the S114 relay is in hand held radio transceivers, wherein the combined features of good RF performance, small size, low coil power dissipation and high reliability make it a preferred method of transmit-receive switching (see Figure 1).

ENVIRONMENTAL AND PHYSICAL SPECIFICATIONS

Temperature (Ambient)	-65°C to +125°C
Vibration	30 g's to 3000 Hz (Note 3)
Shock	75 g's for 6 msec. (Note 3) half-sine
Acceleration	50 g's (Note 3)
Enclosure	All welded, hermetically sealed
Weight	0.07 oz (1.9 gms.) max.
Reflow Temperature	260°C max. temp. 5 min. max. above 180°C

GENERAL ELECTRICAL SPECIFICATIONS (-65°C to +125°C unless otherwise noted) (Notes 1 & 2)

Contact Arrangement	2 Form C (DPDT)	
Rated Duty	Continuous	
Contact Resistance (Note 4)	0.1 ohm max. before life; 0.2 ohm max. after life at 1A/28VDC, (measured 1/8" from header along lead)	
Contact Load Rating (DC) (See Fig. 3 for other DC resistive voltage/current ratings)	Resistive: 1 Amp/28VDC Inductive: 200 mA/28VDC (320 mH) Lamp: 100 mA/28VDC Low Level: 10 to 50 µA/10 to 50 mVDC	
Contact Load Ratings (AC)	Resistive: 250 mA/115VAC, 60 and 400Hz (Case underground) 100 mA/115VAC, 60 and 400Hz (Case grounded)	
Contact Life Ratings	10,000,000 cycles (typical) at low level 1,000,000 cycles (typical) at 0.5A/28VDC resistive 100,000 cycles min. at all other loads specified above	
Contact Overload Rating	2A/28VDC Resistive (100 cycles min.)	
Contact Carry Rating	Contact factory	
Coil Operating Power	450 milliwatts typical at nominal rated voltage @ 25°C	
Operate Time	2.0 msec max. at nominal rated coil voltage @ 25°C	
Release Time	S114 Series: 1.5 msec max.	S114D, S114DD Series: 4.0 msec max.
Contact Bounce	1.5 msec max.	
Intercontact Capacitance	0.4 pf typical	
Insulation Resistance	10,000 megohms min. between mutually isolated terminals	
Dielectric Strength	Atmospheric pressure: 500 VRMS/60 Hz	70,000 ft.: 125 VRMS/60Hz
Diode P.I.V. S114D, S114DD	100 VDC min.	
Negative Coil Transient S114D, S114DD	1.0 VDC max.	

DETAILED ELECTRICAL SPECIFICATIONS (-65°C to +125°C unless otherwise noted) (Note 2)

BASE PART NUMBERS	➔	S114-5	S114-6	S114-9	S114-12	S114-18	S114-26
		S114D-5 S114DD-5	S114D-6 S114DD-6	S114D-9 S114DD-9	S114D-12 S114DD-12	S114D-18 S114DD-18	S114D-26 S114DD-26
Coil Voltage (VDC)	Nom.	5.0	6.0	9.0	12.0	18.0	26.5
	Max.	5.8	8.0	12.0	16.0	24.0	32.0
Coil Resistance (Ohms ± 10% @ 25°C)	S114, S114D	50	98	220	390	880	1560
	S114DD (Note 4)	39	78	220	390	880	1560
Coil Current (mADC @ 25°C) (S114DD Series only)	(Note 4) Min.	93.2	57.8	33.0	25.6	17.5	14.8
	Max.	128.2	74.8	42.9	32.8	22.1	18.5
Pick-up Voltage (VDC, Max.)	S114, S114D	3.5	4.5	6.8	9.0	13.5	18.0
	S114DD	4.0	5.0	7.8	10.0	14.5	19.0
Dropout Voltage (VDC)	S114	Min.	0.14	0.18	0.35	0.59	0.89
	S114D	Max.	2.3	3.2	4.9	6.5	10.0
	S114DD	Min.	0.6	0.7	0.8	0.9	1.1
		Max.	2.8	3.4	5.3	6.5	10.0

PERFORMANCE CURVES (NOTE 1)

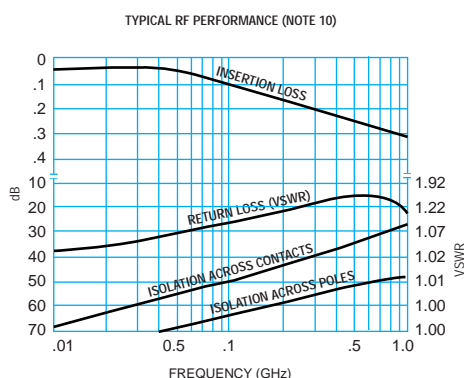

FIGURE 1

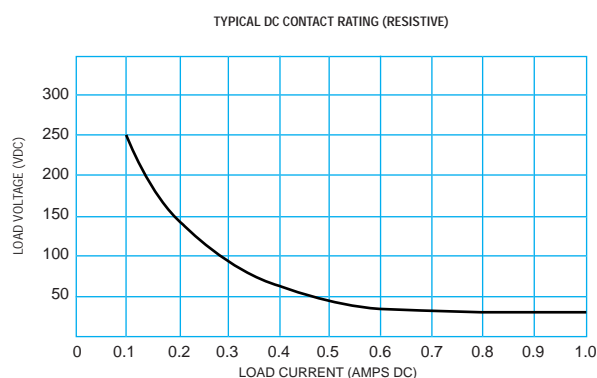
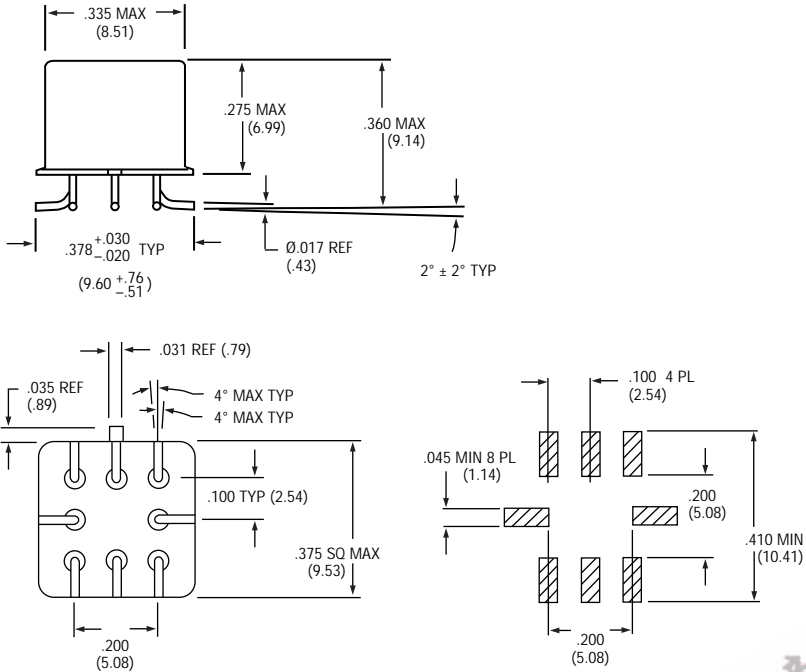

FIGURE 2

SERIES S114

OUTLINE DIMENSIONS AND RECOMMENDED PAD LAYOUT (Notes 6, 7, 8 & 9)



TERMINAL LOCATIONS AND SCHEMATIC DIAGRAMS

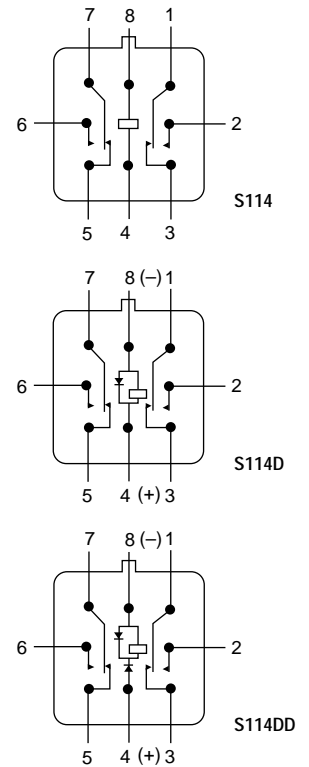

SCHEMATICS ARE VIEWED FROM TERMINALS

TELEDYNE PART NUMBERING SYSTEM FOR SURFACE MOUNT RELAYS

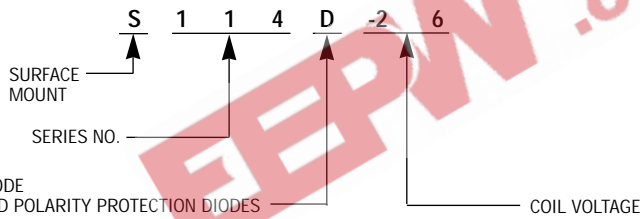

NOTES:

1. Characteristics shown as "typical" are based on available data and are best estimates. No on-going verification tests are performed.
2. Unless otherwise specified, parameters are initial values.
3. Relays will exhibit no chatter in excess of 10 µsec or transfer in excess of 1 µsec.
4. For reference only. Coil resistance not directly measurable at relays terminals due to internal series semiconductor.
5. Measured at nominal voltage for 5 sec. max.
6. Position of leads as they emerge from relay base.
7. Leads will fit noted pad layout with no overhang.
8. Lead ends are coplanar within .008" wide tolerance zone.
9. Terminals coated with SN60 or SN63 solder per QQ-S-571. Kovar exposed at sheared end of leads.
10. RF performance curves based on 114 series relays.