

SA SERIES
500 Watts Transient Voltage Suppressor Diodes
DO-15

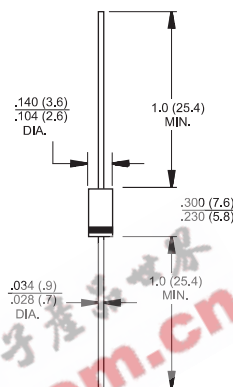

Features

- ✧ Plastic package has Underwriters Laboratory Flammability Classification 94V-0
- ✧ 500W surge capability at 10 X 1000us waveform, duty cycle: 0.01%
- ✧ Excellent clamping capability
- ✧ Low zener impedance
- ✧ Fast response time: Typically less than 1.0ps from 0 volts to VBR for unidirectional and 5.0 ns for bidirectional
- ✧ Typical I_R less than 1 μ A above 10V
- ✧ High temperature soldering guaranteed: 260°C / 10 seconds / .375", (9.5mm) lead length / 5lbs., (2.3kg) tension



Dimensions in inches and (millimeters)

Mechanical Data

- ✧ Case: Molded plastic
- ✧ Lead: Pure tin plated lead free, solderable per MIL-STD-202, Method 208
- ✧ Polarity: Color band denotes cathode except bipolar
- ✧ Weight: 0.34 gram

Maximum Ratings and Electrical Characteristics

Rating at 25°C ambient temperature unless otherwise specified.

| Type Number | Symbol | Value | Units |
|---|----------------|--------------|------------------|
| Peak Power Dissipation at $T_A=25^\circ\text{C}$, $T_p=1\text{ms}$ (Note 1) | P_{PK} | Minimum 500 | Watts |
| Steady State Power Dissipation at $T_L=75^\circ\text{C}$ Lead Lengths .375", 9.5mm (Note 2) | P_D | 3.0 | Watts |
| Peak Forward Surge Current, 8.3 ms Single Half Sine-wave Superimposed on Rated Load (JEDEC method) (Note 3) | I_{FSM} | 70 | Amps |
| Maximum Instantaneous Forward Voltage at 35.0A for Unidirectional Only | V_F | 3.5 | Volts |
| Operating and Storage Temperature Range | T_J, T_{STG} | -55 to + 175 | $^\circ\text{C}$ |

- Notes:
1. Non-repetitive Current Pulse Per Fig. 3 and Derated above $T_A=25^\circ\text{C}$ Per Fig. 2.
 2. Mounted on Copper Pad Area of 1.6 x 1.6" (40 x 40 mm) Per Fig. 2.
 3. 8.3ms Single Half Sine-wave or Equivalent Square Wave, Duty Cycle=4 Pulses Per Minutes Maximum.

Devices for Bipolar Applications

1. For Bidirectional Use C or CA Suffix for Types SA5.0 through Types SA170.
2. Electrical Characteristics Apply in Both Directions.

RATINGS AND CHARACTERISTIC CURVES (SA SERIES)

FIG.1- PEAK PULSE POWER RATING CURVE

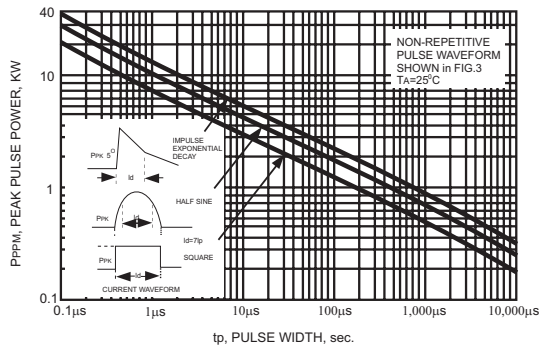

FIG.2- POWER DERATING CURVE

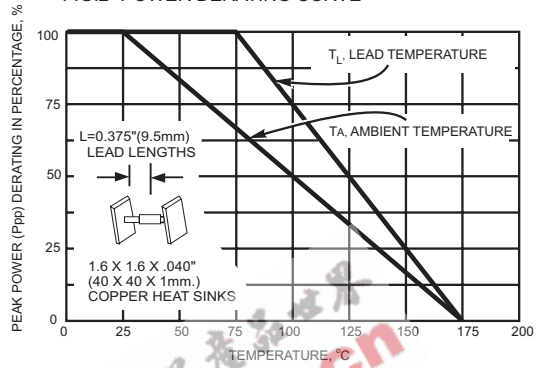

FIG.3- CLAMPING POWER PULSE WAVEFORM

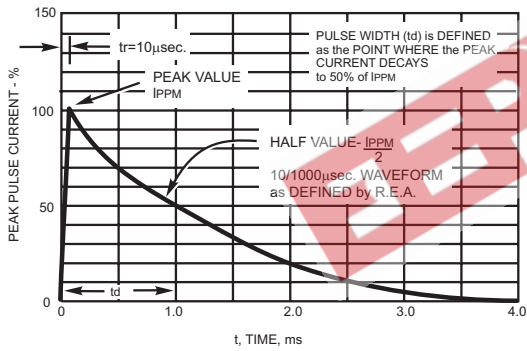

FIG.4- MAXIMUM NON-REPETITIVE FORWARD SURGE CURRENT UNIDIRECTIONAL ONLY

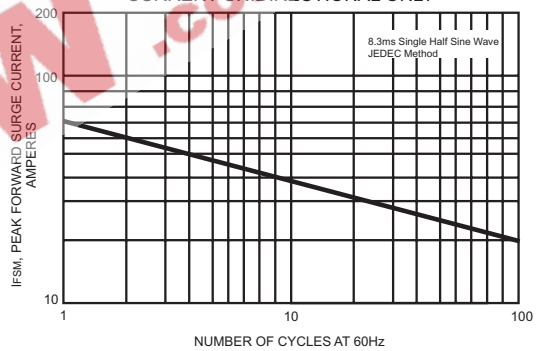
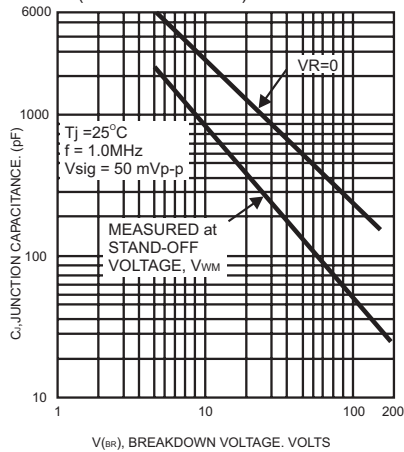

FIG.5- TYPICAL JUNCTION CAPACITANCE (UNIDIRECTIONAL)



ELECTRICAL CHARACTERISTICS (TA=25°C unless otherwise noted)

| Device | Breakdown Voltage | | Test Current @IT (mA) | Stand-Off Voltage VWM (Volts) | Maximum Reverse Leakage at VWM Id (uA) | Maximum Peak Pulse Current IPPM (Note 2)(Amps) | Maximum Clamping Voltage at IPPM Vc(Volts) | Maximum Temperature Coefficient of VBR mV / °C) |
|--------|----------------------|------|-----------------------|-------------------------------|--|--|--|---|
| | VBR (Volts) (Note 1) | | | | | | | |
| | Min | Max | | | | | | |
| SA5.0 | 6.40 | 7.30 | 10 | 5.0 | 600 | 54.0 | 9.60 | 5.0 |
| SA5.0A | 6.40 | 7.00 | 10 | 5.0 | 600 | 57.0 | 9.20 | 5.0 |
| SA6.0 | 6.67 | 8.15 | 10 | 6.0 | 600 | 46.0 | 11.4 | 5.0 |
| SA6.0A | 6.67 | 7.37 | 10 | 6.0 | 600 | 50.0 | 10.3 | 5.0 |
| SA6.5 | 7.22 | 8.82 | 10 | 6.5 | 400 | 42.0 | 12.3 | 5.0 |
| SA6.5A | 7.22 | 7.98 | 10 | 6.5 | 400 | 46.0 | 11.2 | 5.0 |
| SA7.0 | 7.78 | 9.51 | 10 | 7.0 | 150 | 39.0 | 13.3 | 6.0 |
| SA7.0A | 7.78 | 8.60 | 10 | 7.0 | 150 | 43.0 | 12.0 | 6.0 |
| SA7.5 | 8.33 | 10.2 | 1.0 | 7.5 | 50 | 36.0 | 14.3 | 7.0 |
| SA7.5A | 8.33 | 9.21 | 1.0 | 7.5 | 50 | 40.0 | 12.9 | 7.0 |
| SA8.0 | 8.89 | 10.9 | 1.0 | 8.0 | 25 | 35.0 | 15.0 | 7.0 |
| SA8.0A | 8.89 | 9.83 | 1.0 | 8.0 | 25 | 38.0 | 13.6 | 7.0 |
| SA8.5 | 9.44 | 11.5 | 1.0 | 8.5 | 10 | 33.0 | 15.9 | 8.0 |
| SA8.5A | 9.44 | 10.4 | 1.0 | 8.5 | 10 | 36.0 | 14.4 | 8.0 |
| SA9.0 | 10.0 | 12.2 | 1.0 | 9.0 | 5.0 | 31.0 | 16.9 | 9.0 |
| SA9.0A | 10.0 | 11.1 | 1.0 | 9.0 | 5.0 | 34.0 | 15.4 | 9.0 |
| SA10 | 11.1 | 13.6 | 1.0 | 10.0 | 1.0 | 27.0 | 18.8 | 10.0 |
| SA10A | 11.1 | 12.3 | 1.0 | 10.0 | 1.0 | 30.0 | 17.0 | 10.0 |
| SA11 | 12.2 | 14.9 | 1.0 | 11.0 | 1.0 | 26.0 | 20.1 | 11.0 |
| SA11A | 12.2 | 13.5 | 1.0 | 11.0 | 1.0 | 28.0 | 18.2 | 11.0 |
| SA12 | 13.3 | 16.3 | 1.0 | 12.0 | 1.0 | 23.0 | 22.0 | 12.0 |
| SA12A | 13.3 | 14.7 | 1.0 | 12.0 | 1.0 | 26.3 | 19.9 | 12.0 |
| SA13 | 14.4 | 17.6 | 1.0 | 13.0 | 1.0 | 22.0 | 23.8 | 13.0 |
| SA13A | 14.4 | 15.9 | 1.0 | 13.0 | 1.0 | 24.0 | 21.5 | 13.0 |
| SA14 | 15.6 | 19.1 | 1.0 | 14.0 | 1.0 | 20.3 | 25.8 | 14.0 |
| SA14A | 15.6 | 17.2 | 1.0 | 14.0 | 1.0 | 22.6 | 23.2 | 14.0 |
| SA15 | 16.7 | 20.4 | 1.0 | 15.0 | 1.0 | 19.5 | 26.9 | 16.0 |
| SA15A | 16.7 | 18.5 | 1.0 | 15.0 | 1.0 | 21.0 | 24.4 | 16.0 |
| SA16 | 17.8 | 21.8 | 1.0 | 16.0 | 1.0 | 18.0 | 28.8 | 19.0 |
| SA16A | 17.8 | 19.7 | 1.0 | 16.0 | 1.0 | 20.0 | 26.0 | 17.0 |
| SA17 | 18.9 | 23.1 | 1.0 | 17.0 | 1.0 | 17.0 | 30.5 | 20.0 |
| SA17A | 18.9 | 20.9 | 1.0 | 17.0 | 1.0 | 19.0 | 27.6 | 19.0 |
| SA18 | 20.0 | 24.4 | 1.0 | 18.0 | 1.0 | 16.3 | 32.2 | 21.0 |
| SA18A | 20.0 | 22.1 | 1.0 | 18.0 | 1.0 | 17.9 | 29.2 | 20.0 |
| SA20 | 22.2 | 27.1 | 1.0 | 20.0 | 1.0 | 14.0 | 35.8 | 25.0 |
| SA20A | 22.2 | 24.5 | 1.0 | 20.0 | 1.0 | 16.0 | 32.4 | 23.0 |
| SA22 | 24.4 | 29.8 | 1.0 | 22.0 | 1.0 | 13.0 | 39.4 | 28.0 |
| SA22A | 24.4 | 26.9 | 1.0 | 22.0 | 1.0 | 14.7 | 35.5 | 25.0 |
| SA24 | 26.7 | 32.6 | 1.0 | 24.0 | 1.0 | 12.0 | 43.0 | 31.0 |
| SA24A | 26.7 | 29.5 | 1.0 | 24.0 | 1.0 | 13.4 | 38.9 | 28.0 |
| SA26 | 28.9 | 35.3 | 1.0 | 26.0 | 1.0 | 11.0 | 46.6 | 31.0 |
| SA26A | 28.9 | 31.9 | 1.0 | 26.0 | 1.0 | 12.4 | 42.1 | 30.0 |
| SA28 | 31.1 | 38.0 | 1.0 | 28.0 | 1.0 | 10.0 | 50.1 | 35.0 |
| SA28A | 31.1 | 34.4 | 1.0 | 28.0 | 1.0 | 11.5 | 45.4 | 31.0 |
| SA30 | 33.3 | 40.7 | 1.0 | 30.0 | 1.0 | 9.8 | 53.5 | 39.0 |
| SA30A | 33.3 | 36.8 | 1.0 | 30.0 | 1.0 | 10.8 | 48.4 | 36.0 |
| SA33 | 36.7 | 44.9 | 1.0 | 33.0 | 1.0 | 8.8 | 59.0 | 42.0 |
| SA33A | 36.7 | 40.6 | 1.0 | 33.0 | 1.0 | 9.8 | 53.3 | 39.0 |
| SA36 | 40.0 | 48.9 | 1.0 | 36.0 | 1.0 | 8.1 | 64.3 | 46.0 |
| SA36A | 40.0 | 44.2 | 1.0 | 36.0 | 1.0 | 9.0 | 58.1 | 41.0 |
| SA40 | 44.4 | 54.3 | 1.0 | 40.0 | 1.0 | 7.3 | 71.4 | 51.0 |
| SA40A | 44.4 | 49.1 | 1.0 | 40.0 | 1.0 | 8.1 | 64.5 | 46.0 |
| SA43 | 47.8 | 58.4 | 1.0 | 43.0 | 1.0 | 6.8 | 76.7 | 55.0 |
| SA43A | 47.8 | 52.8 | 1.0 | 43.0 | 1.0 | 7.5 | 69.4 | 50.0 |

ELECTRICAL CHARACTERISTICS (TA=25°C unless otherwise noted)

| Device | Breakdown Voltage | | Test Current @I _T (mA) | Stand-Off Voltage V _{WM} (Volts) | Maximum Reverse Leakage at V _{WM} I _D (uA) | Maximum Peak Pulse Current I _{PPM} (Note 2)(Amps) | Maximum Clamping Voltage at I _{PPM} V _C (Volts) | Maximum Temperature Coefficient of V _{BR} mV /°C) |
|--------|----------------------------------|------|-----------------------------------|---|--|--|---|--|
| | V _{BR} (Volts) (Note 1) | | | | | | | |
| | Min | Max | | | | | | |
| SA45 | 50.0 | 61.1 | 1.0 | 45.0 | 1.0 | 6.5 | 80.3 | 58.0 |
| SA45A | 50.0 | 55.3 | 1.0 | 45.0 | 1.0 | 7.2 | 72.7 | 52.0 |
| SA48 | 53.3 | 65.2 | 1.0 | 48.0 | 1.0 | 6.1 | 85.5 | 63.0 |
| SA48A | 53.3 | 58.9 | 1.0 | 48.0 | 1.0 | 6.7 | 77.4 | 56.0 |
| SA51 | 56.7 | 69.3 | 1.0 | 51.0 | 1.0 | 5.7 | 91.1 | 66.0 |
| SA51A | 56.7 | 62.7 | 1.0 | 51.0 | 1.0 | 6.3 | 82.4 | 61.0 |
| SA54 | 60.0 | 73.3 | 1.0 | 54.0 | 1.0 | 5.4 | 96.3 | 71.0 |
| SA54A | 60.0 | 66.3 | 1.0 | 54.0 | 1.0 | 6.0 | 87.1 | 65.0 |
| SA58 | 64.4 | 78.7 | 1.0 | 58.0 | 1.0 | 5.0 | 103 | 78.0 |
| SA58A | 64.4 | 71.2 | 1.0 | 58.0 | 1.0 | 5.6 | 93.6 | 70.0 |
| SA60 | 66.7 | 81.5 | 1.0 | 60.0 | 1.0 | 4.9 | 107 | 80.0 |
| SA60A | 66.7 | 73.7 | 1.0 | 60.0 | 1.0 | 5.4 | 96.8 | 71.0 |
| SA64 | 71.1 | 86.9 | 1.0 | 64.0 | 1.0 | 4.6 | 114 | 86.0 |
| SA64A | 71.1 | 78.6 | 1.0 | 64.0 | 1.0 | 5.0 | 103 | 76.0 |
| SA70 | 77.8 | 95.1 | 1.0 | 70.0 | 1.0 | 4.2 | 125 | 94.0 |
| SA70A | 77.8 | 86 | 1.0 | 70.0 | 1.0 | 4.6 | 113 | 85.0 |
| SA75 | 88.3 | 102 | 1.0 | 75.0 | 1.0 | 3.9 | 134 | 101 |
| SA75A | 88.3 | 92.1 | 1.0 | 75.0 | 1.0 | 4.3 | 121 | 91 |
| SA78 | 86.7 | 103 | 1.0 | 78.0 | 1.0 | 3.7 | 139 | 105 |
| SA78A | 86.7 | 95.8 | 1.0 | 78.0 | 1.0 | 4.1 | 126 | 95 |
| SA85 | 94.4 | 115 | 1.0 | 85.0 | 1.0 | 3.4 | 151 | 114 |
| SA85A | 94.4 | 104 | 1.0 | 85.0 | 1.0 | 3.8 | 137 | 103 |
| SA90 | 100 | 122 | 1.0 | 90.0 | 1.0 | 3.2 | 160 | 121 |
| SA90A | 100 | 111 | 1.0 | 90.0 | 1.0 | 3.5 | 146 | 110 |
| SA100 | 111 | 136 | 1.0 | 100 | 1.0 | 2.9 | 179 | 135 |
| SA100A | 111 | 123 | 1.0 | 100 | 1.0 | 3.2 | 162 | 123 |
| SA110 | 122 | 149 | 1.0 | 110 | 1.0 | 2.6 | 196 | 148 |
| SA110A | 122 | 135 | 1.0 | 110 | 1.0 | 2.9 | 177 | 133 |
| SA120 | 133 | 163 | 1.0 | 120 | 1.0 | 2.4 | 214 | 162 |
| SA120A | 133 | 147 | 1.0 | 120 | 1.0 | 2.7 | 193 | 146 |
| SA130 | 144 | 176 | 1.0 | 130 | 1.0 | 2.2 | 230 | 175 |
| SA130A | 144 | 159 | 1.0 | 130 | 1.0 | 2.5 | 209 | 158 |
| SA150 | 167 | 204 | 1.0 | 150 | 1.0 | 1.9 | 268 | 203 |
| SA150A | 167 | 185 | 1.0 | 150 | 1.0 | 2.1 | 243 | 184 |
| SA160 | 178 | 218 | 1.0 | 160 | 1.0 | 2.0 | 257 | 217 |
| SA160A | 178 | 197 | 1.0 | 160 | 1.0 | 2.0 | 259 | 196 |
| SA170 | 189 | 231 | 1.0 | 170 | 1.0 | 1.7 | 304 | 230 |
| SA170A | 189 | 209 | 1.0 | 170 | 1.0 | 1.9 | 275 | 208 |

Notes:

1. V_{BR} measured after I_T applied for 300us, I_T = square wave pulse or equivalent.
2. Surge current waveform per Figure 3 and derate per Figure 2.
3. For bipolar types with V_{WM} of 10 Volts and under, the I_D limit is doubled.
4. All terms and symbols are consistent ANSI/IEEE C62.35.

TVS APPLICATION NOTES:

Transient Voltage Suppressors may be used at various points in a circuit to provide various degrees of protection. The following is a typical linear power supply with transient voltage suppressor units placed at different points. All provide protection of the load.

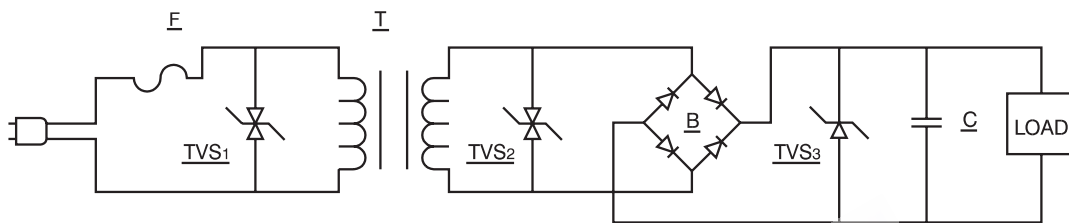

FIGURE 1

Transient Voltage Suppressors 1 provides maximum protection. However, the system will probably require replacement of the line fuse(F) since it provides a dominant portion of the series impedance when a surge is encountered.

However, we do not recommend to use the TVS diode here, unless we can know the electric circuit impedance and the magnitude of surge rushed into the circuit. Otherwise the TVS diode is easy to be destroyed by voltage surge.

Transient Voltage Suppressor 2 provides excellent protection of circuitry excluding the transformer(T). However, since the transformer is a large part of the series impedance, the chance of the line fuse opening during the surge condition is reduced.

Transient Voltage Suppressor 3 provides the load with complete protection. It uses a unidirectional Transient Voltage Suppressor, which is a cost advantage. The series impedance now includes the line fuse, transformer, and bridge rectifier(B) so failure of the line fuse is further reduced. If only Transient Voltage Suppressor 3 is in use, then the bridge rectifier is unprotected and would require a higher voltage and current rating to prevent failure by transients.

Any combination of these three, or any one of these applications, will prevent damage to the load. This would require varying trade-offs in power supply protection versus maintenance(changing the time fuse).

An additional method is to utilize the Transient Voltage Suppressor units as a controlled avalanche bridge. This reduces the parts count and incorporates the protection within the bridge rectifier.

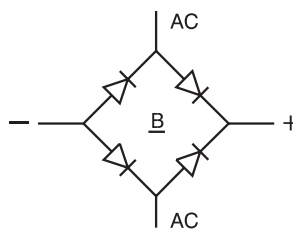

FIGURE 2