

SA SERIES

500 Watts Transient Voltage Suppressor Diodes

DO-15



Features

- ✧ Plastic package has Underwriters Laboratory Flammability Classification 94V-0
- ✧ 500W surge capability at 10 X 1000us waveform, duty cycle: 0.01%
- ✧ Excellent clamping capability
- ✧ Low zener impedance
- ✧ Fast response time: Typically less than 1.0ps from 0 volts to VBR for unidirectional and 5.0 ns for bidirectional
- ✧ Typical I_R less than 1 μ A above 10V
- ✧ High temperature soldering guaranteed: 260°C / 10 seconds / .375", (9.5mm) lead length / 5lbs., (2.3kg) tension

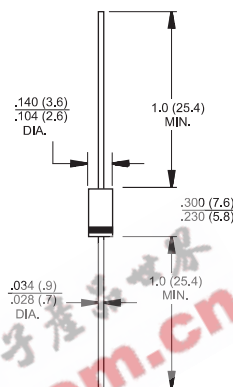

Dimensions in inches and (millimeters)

Mechanical Data

- ✧ Case: Molded plastic
- ✧ Lead: Pure tin plated lead free, solderable per MIL-STD-202, Method 208
- ✧ Polarity: Color band denotes cathode except bipolar
- ✧ Weight: 0.34 gram

Maximum Ratings and Electrical Characteristics

Rating at 25°C ambient temperature unless otherwise specified.

Type Number	Symbol	Value	Units
Peak Power Dissipation at $T_A=25^\circ\text{C}$, $T_p=1\text{ms}$ (Note 1)	P_{PK}	Minimum 500	Watts
Steady State Power Dissipation at $T_L=75^\circ\text{C}$ Lead Lengths .375", 9.5mm (Note 2)	P_D	3.0	Watts
Peak Forward Surge Current, 8.3 ms Single Half Sine-wave Superimposed on Rated Load (JEDEC method) (Note 3)	I_{FSM}	70	Amps
Maximum Instantaneous Forward Voltage at 35.0A for Unidirectional Only	V_F	3.5	Volts
Operating and Storage Temperature Range	T_J, T_{STG}	-55 to + 175	$^\circ\text{C}$

- Notes:
1. Non-repetitive Current Pulse Per Fig. 3 and Derated above $T_A=25^\circ\text{C}$ Per Fig. 2.
 2. Mounted on Copper Pad Area of 1.6 x 1.6" (40 x 40 mm) Per Fig. 2.
 3. 8.3ms Single Half Sine-wave or Equivalent Square Wave, Duty Cycle=4 Pulses Per Minutes Maximum.

Devices for Bipolar Applications

1. For Bidirectional Use C or CA Suffix for Types SA5.0 through Types SA170.
2. Electrical Characteristics Apply in Both Directions.

RATINGS AND CHARACTERISTIC CURVES (SA SERIES)

FIG.1- PEAK PULSE POWER RATING CURVE

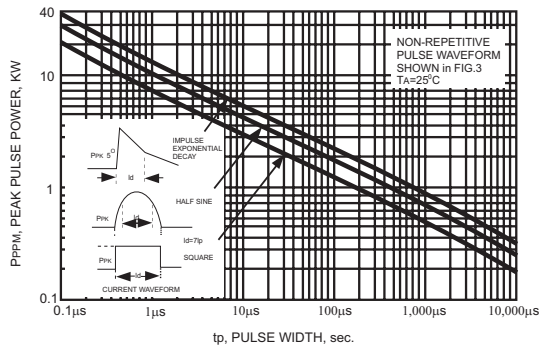

FIG.2- POWER DERATING CURVE

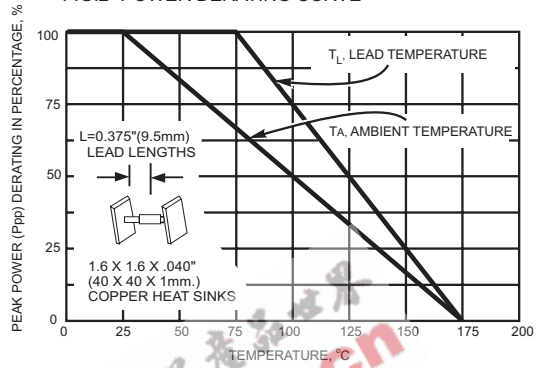

FIG.3- CLAMPING POWER PULSE WAVEFORM

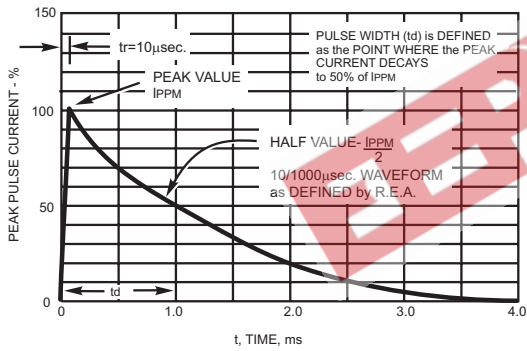

FIG.4- MAXIMUM NON-REPETITIVE FORWARD SURGE CURRENT UNIDIRECTIONAL ONLY

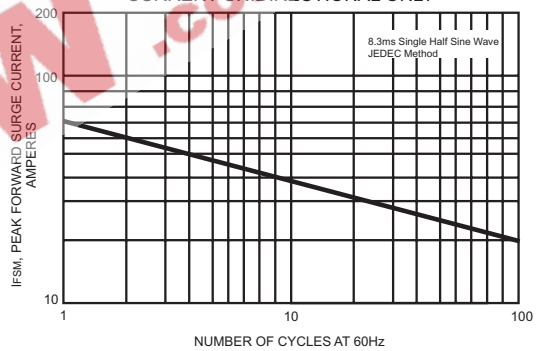
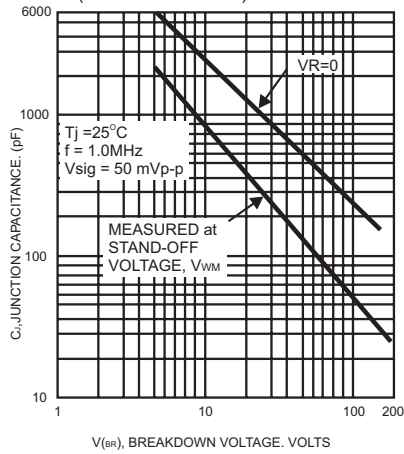

FIG.5- TYPICAL JUNCTION CAPACITANCE (UNIDIRECTIONAL)



ELECTRICAL CHARACTERISTICS (TA=25°C unless otherwise noted)

Device	Breakdown Voltage		Test Current @IT (mA)	Stand-Off Voltage VWM (Volts)	Maximum Reverse Leakage at VWM Id (uA)	Maximum Peak Pulse Current IPPM (Note 2)(Amps)	Maximum Clamping Voltage at IPPM Vc(Volts)	Maximum Temperature Coefficient of VBR mV / °C)
	VBR (Volts) (Note 1)							
	Min	Max						
SA5.0	6.40	7.30	10	5.0	600	54.0	9.60	5.0
SA5.0A	6.40	7.00	10	5.0	600	57.0	9.20	5.0
SA6.0	6.67	8.15	10	6.0	600	46.0	11.4	5.0
SA6.0A	6.67	7.37	10	6.0	600	50.0	10.3	5.0
SA6.5	7.22	8.82	10	6.5	400	42.0	12.3	5.0
SA6.5A	7.22	7.98	10	6.5	400	46.0	11.2	5.0
SA7.0	7.78	9.51	10	7.0	150	39.0	13.3	6.0
SA7.0A	7.78	8.60	10	7.0	150	43.0	12.0	6.0
SA7.5	8.33	10.2	1.0	7.5	50	36.0	14.3	7.0
SA7.5A	8.33	9.21	1.0	7.5	50	40.0	12.9	7.0
SA8.0	8.89	10.9	1.0	8.0	25	35.0	15.0	7.0
SA8.0A	8.89	9.83	1.0	8.0	25	38.0	13.6	7.0
SA8.5	9.44	11.5	1.0	8.5	10	33.0	15.9	8.0
SA8.5A	9.44	10.4	1.0	8.5	10	36.0	14.4	8.0
SA9.0	10.0	12.2	1.0	9.0	5.0	31.0	16.9	9.0
SA9.0A	10.0	11.1	1.0	9.0	5.0	34.0	15.4	9.0
SA10	11.1	13.6	1.0	10.0	1.0	27.0	18.8	10.0
SA10A	11.1	12.3	1.0	10.0	1.0	30.0	17.0	10.0
SA11	12.2	14.9	1.0	11.0	1.0	26.0	20.1	11.0
SA11A	12.2	13.5	1.0	11.0	1.0	28.0	18.2	11.0
SA12	13.3	16.3	1.0	12.0	1.0	23.0	22.0	12.0
SA12A	13.3	14.7	1.0	12.0	1.0	26.3	19.9	12.0
SA13	14.4	17.6	1.0	13.0	1.0	22.0	23.8	13.0
SA13A	14.4	15.9	1.0	13.0	1.0	24.0	21.5	13.0
SA14	15.6	19.1	1.0	14.0	1.0	20.3	25.8	14.0
SA14A	15.6	17.2	1.0	14.0	1.0	22.6	23.2	14.0
SA15	16.7	20.4	1.0	15.0	1.0	19.5	26.9	16.0
SA15A	16.7	18.5	1.0	15.0	1.0	21.0	24.4	16.0
SA16	17.8	21.8	1.0	16.0	1.0	18.0	28.8	19.0
SA16A	17.8	19.7	1.0	16.0	1.0	20.0	26.0	17.0
SA17	18.9	23.1	1.0	17.0	1.0	17.0	30.5	20.0
SA17A	18.9	20.9	1.0	17.0	1.0	19.0	27.6	19.0
SA18	20.0	24.4	1.0	18.0	1.0	16.3	32.2	21.0
SA18A	20.0	22.1	1.0	18.0	1.0	17.9	29.2	20.0
SA20	22.2	27.1	1.0	20.0	1.0	14.0	35.8	25.0
SA20A	22.2	24.5	1.0	20.0	1.0	16.0	32.4	23.0
SA22	24.4	29.8	1.0	22.0	1.0	13.0	39.4	28.0
SA22A	24.4	26.9	1.0	22.0	1.0	14.7	35.5	25.0
SA24	26.7	32.6	1.0	24.0	1.0	12.0	43.0	31.0
SA24A	26.7	29.5	1.0	24.0	1.0	13.4	38.9	28.0
SA26	28.9	35.3	1.0	26.0	1.0	11.0	46.6	31.0
SA26A	28.9	31.9	1.0	26.0	1.0	12.4	42.1	30.0
SA28	31.1	38.0	1.0	28.0	1.0	10.0	50.1	35.0
SA28A	31.1	34.4	1.0	28.0	1.0	11.5	45.4	31.0
SA30	33.3	40.7	1.0	30.0	1.0	9.8	53.5	39.0
SA30A	33.3	36.8	1.0	30.0	1.0	10.8	48.4	36.0
SA33	36.7	44.9	1.0	33.0	1.0	8.8	59.0	42.0
SA33A	36.7	40.6	1.0	33.0	1.0	9.8	53.3	39.0
SA36	40.0	48.9	1.0	36.0	1.0	8.1	64.3	46.0
SA36A	40.0	44.2	1.0	36.0	1.0	9.0	58.1	41.0
SA40	44.4	54.3	1.0	40.0	1.0	7.3	71.4	51.0
SA40A	44.4	49.1	1.0	40.0	1.0	8.1	64.5	46.0
SA43	47.8	58.4	1.0	43.0	1.0	6.8	76.7	55.0
SA43A	47.8	52.8	1.0	43.0	1.0	7.5	69.4	50.0

ELECTRICAL CHARACTERISTICS (TA=25°C unless otherwise noted)

Device	Breakdown Voltage		Test Current @I _T (mA)	Stand-Off Voltage V _{WM} (Volts)	Maximum Reverse Leakage at V _{WM} I _D (uA)	Maximum Peak Pulse Current I _{PPM} (Note 2)(Amps)	Maximum Clamping Voltage at I _{PPM} V _C (Volts)	Maximum Temperature Coefficient of V _{BR} mV /°C)
	V _{BR} (Volts) (Note 1)							
	Min	Max						
SA45	50.0	61.1	1.0	45.0	1.0	6.5	80.3	58.0
SA45A	50.0	55.3	1.0	45.0	1.0	7.2	72.7	52.0
SA48	53.3	65.2	1.0	48.0	1.0	6.1	85.5	63.0
SA48A	53.3	58.9	1.0	48.0	1.0	6.7	77.4	56.0
SA51	56.7	69.3	1.0	51.0	1.0	5.7	91.1	66.0
SA51A	56.7	62.7	1.0	51.0	1.0	6.3	82.4	61.0
SA54	60.0	73.3	1.0	54.0	1.0	5.4	96.3	71.0
SA54A	60.0	66.3	1.0	54.0	1.0	6.0	87.1	65.0
SA58	64.4	78.7	1.0	58.0	1.0	5.0	103	78.0
SA58A	64.4	71.2	1.0	58.0	1.0	5.6	93.6	70.0
SA60	66.7	81.5	1.0	60.0	1.0	4.9	107	80.0
SA60A	66.7	73.7	1.0	60.0	1.0	5.4	96.8	71.0
SA64	71.1	86.9	1.0	64.0	1.0	4.6	114	86.0
SA64A	71.1	78.6	1.0	64.0	1.0	5.0	103	76.0
SA70	77.8	95.1	1.0	70.0	1.0	4.2	125	94.0
SA70A	77.8	86	1.0	70.0	1.0	4.6	113	85.0
SA75	88.3	102	1.0	75.0	1.0	3.9	134	101
SA75A	88.3	92.1	1.0	75.0	1.0	4.3	121	91
SA78	86.7	103	1.0	78.0	1.0	3.7	139	105
SA78A	86.7	95.8	1.0	78.0	1.0	4.1	126	95
SA85	94.4	115	1.0	85.0	1.0	3.4	151	114
SA85A	94.4	104	1.0	85.0	1.0	3.8	137	103
SA90	100	122	1.0	90.0	1.0	3.2	160	121
SA90A	100	111	1.0	90.0	1.0	3.5	146	110
SA100	111	136	1.0	100	1.0	2.9	179	135
SA100A	111	123	1.0	100	1.0	3.2	162	123
SA110	122	149	1.0	110	1.0	2.6	196	148
SA110A	122	135	1.0	110	1.0	2.9	177	133
SA120	133	163	1.0	120	1.0	2.4	214	162
SA120A	133	147	1.0	120	1.0	2.7	193	146
SA130	144	176	1.0	130	1.0	2.2	230	175
SA130A	144	159	1.0	130	1.0	2.5	209	158
SA150	167	204	1.0	150	1.0	1.9	268	203
SA150A	167	185	1.0	150	1.0	2.1	243	184
SA160	178	218	1.0	160	1.0	2.0	257	217
SA160A	178	197	1.0	160	1.0	2.0	259	196
SA170	189	231	1.0	170	1.0	1.7	304	230
SA170A	189	209	1.0	170	1.0	1.9	275	208

Notes:

1. V_{BR} measured after I_T applied for 300us, I_T = square wave pulse or equivalent.
2. Surge current waveform per Figure 3 and derate per Figure 2.
3. For bipolar types with V_{WM} of 10 Volts and under, the I_D limit is doubled.
4. All terms and symbols are consistent ANSI/IEEE C62.35.

TVS APPLICATION NOTES:

Transient Voltage Suppressors may be used at various points in a circuit to provide various degrees of protection. The following is a typical linear power supply with transient voltage suppressor units placed at different points. All provide protection of the load.

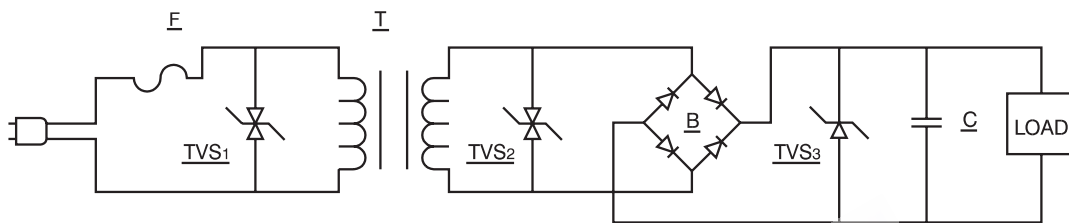

FIGURE 1

Transient Voltage Suppressors 1 provides maximum protection. However, the system will probably require replacement of the line fuse(F) since it provides a dominant portion of the series impedance when a surge is encountered.

However, we do not recommend to use the TVS diode here, unless we can know the electric circuit impedance and the magnitude of surge rushed into the circuit. Otherwise the TVS diode is easy to be destroyed by voltage surge.

Transient Voltage Suppressor 2 provides excellent protection of circuitry excluding the transformer(T). However, since the transformer is a large part of the series impedance, the chance of the line fuse opening during the surge condition is reduced.

Transient Voltage Suppressor 3 provides the load with complete protection. It uses a unidirectional Transient Voltage Suppressor, which is a cost advantage. The series impedance now includes the line fuse, transformer, and bridge rectifier(B) so failure of the line fuse is further reduced. If only Transient Voltage Suppressor 3 is in use, then the bridge rectifier is unprotected and would require a higher voltage and current rating to prevent failure by transients.

Any combination of these three, or any one of these applications, will prevent damage to the load. This would require varying trade-offs in power supply protection versus maintenance(changing the time fuse).

An additional method is to utilize the Transient Voltage Suppressor units as a controlled avalanche bridge. This reduces the parts count and incorporates the protection within the bridge rectifier.

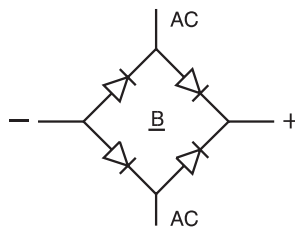

FIGURE 2