

## Contents

Features .....	1
Block Diagram .....	1
Pin Arrangement .....	1
Dimensions .....	2
Absolute Maximum Ratings .....	2
Electrical Characteristics .....	2
Definition of Terms .....	3
Application Temperature Switch .....	4
Characteristics .....	5

**EEPW** 电子產品世界  
.com.cn

The S-8100BF is a high-precision temperature compensation IC, integrated on a single chip with a linear output voltage of  $-8.1\text{mV/K}$ . It is composed of a temperature sensor, a constant current circuit, and an operational amplifier. Its temperature range is from  $-40^\circ\text{C}$  to  $+100^\circ\text{C}$ . The S-8100BF has much better linearity than other temperature sensors such as thermistors. It can be used for a wide application range of temperature controls.

■ Features

- Linear output voltage :  $-8.1\text{mV/K} (-8.1\text{mV}/^\circ\text{C})$   
 $T_a = -20^\circ\text{C} : 1.900\text{V}$   
 $T_a = +30^\circ\text{C} : 1.497\text{V}$   
 $T_a = +80^\circ\text{C} : 1.085\text{V}$
- Linearity :  $\pm 1.0\%$  ( $-20^\circ\text{C}$  to  $+80^\circ\text{C}$ )
- Repeatability :  $\pm 0.3\%$
- $V_{SS}$  standard output
- Built-in operational amplifier
- Current consumption :  $10\mu\text{A}$  ( $25^\circ\text{C}$ ) typ.
- Compact 3-pin plastic package

■ Pin Arrangement

■ Block Diagram

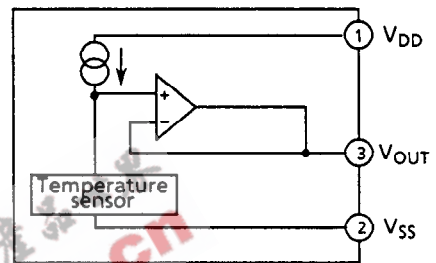
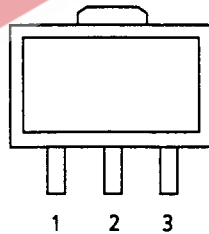

Figure 1

SOT-89-3



- 1  $V_{DD}$
- 2  $V_{SS}$
- 3  $V_{OUT}$

Figure 2

# CMOS TEMPERATURE COMPENSATION IC S-8100BF

## ■ Dimensions

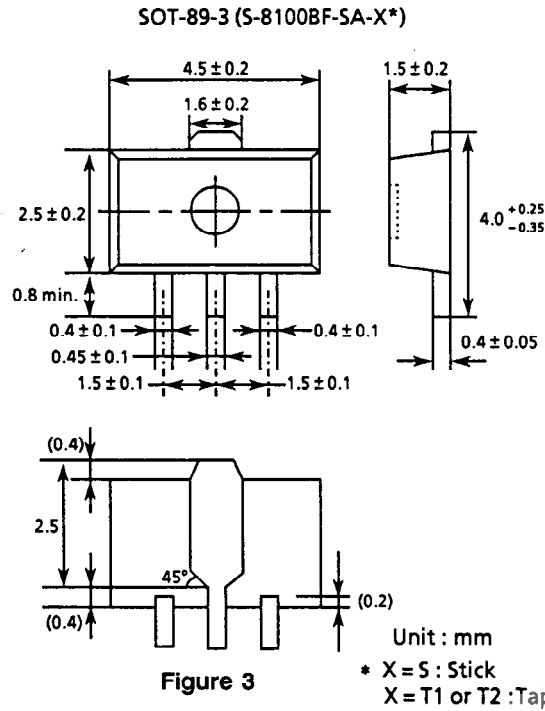

Figure 3

## ■ Absolute Maximum Ratings

Table 1

Parameter	Symbol	Ratings	Unit
Power supply voltage ( $V_{SS} = 0V$ )	$V_{DD}$	6	V
Input / output voltage	$V_{IN}, V_{OUT}$	$V_{SS}$ to $V_{DD}$	V
Operating temperature	$T_{opr}$	-40 to +100	°C
Storage temperature	$T_{stg}$	-55 to +125	°C

## ■ Electrical Characteristics

Table 2

( $-40^{\circ}C \leq T_a \leq +100^{\circ}C$ ,  $V_{DD} = 5.0V$ )

Parameter	Symbol	Conditions	Min.	Typ.	Max.	Unit
Power supply voltage	$V_{DD}$		3.0	5.0	5.5	V
Temperature sensitivity	$V_{SE}$	$-20^{\circ}C \leq T_a \leq +80^{\circ}C$	—	-8.14	—	mV/°C
Output voltage	$V_{OUT}$	$T_a = -20^{\circ}C$	1.852	1.900	1.964	V
		$T_a = +30^{\circ}C$	1.452	1.497	1.564	V
		$T_a = +80^{\circ}C$	1.039	1.085	1.151	V
Linearity	$\Delta NL$	$-20^{\circ}C$ to $+80^{\circ}C$	—	—	$\pm 1.0$	%
Reproducibility	$\Delta V_{OUT}$		—	—	$\pm 0.3$	%
Operating temperature	$T_{opr}$	$\Delta NL \leq \pm 2.0\%$	-40	—	100	°C
Current consumption	$I_{DD}$	$T_a = +25^{\circ}C$	—	10	20	$\mu A$
Output resistance	$R_o$	$T_a = +25^{\circ}C$	—	50	—	k $\Omega$

■ Definition of Terms

1. Deviation of  $V_{OUT}$

Maximum output voltage difference at  $-20^{\circ}\text{C}$ ,  $30^{\circ}\text{C}$ , and  $80^{\circ}\text{C}$

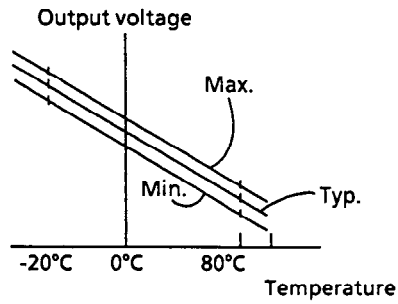

2. Linearity ( $\Delta\text{NL}$ )

$$\Delta\text{NL} = \frac{a}{b}$$

a : Maximum output voltage difference between (A) and (B)

b : Output voltage

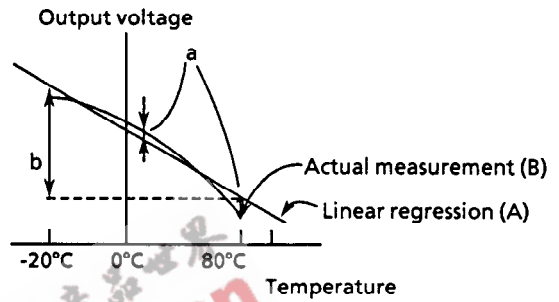

3. Reproducibility ( $\Delta V_{OUT}$ )

$$\Delta V_{OUT} = \frac{c}{b}$$

Maximum output voltage difference between before and after long-term reliability tests (1000H, high temperature and high humidity, etc.)

(Long-term reliability test at high temperature and under high humidity)

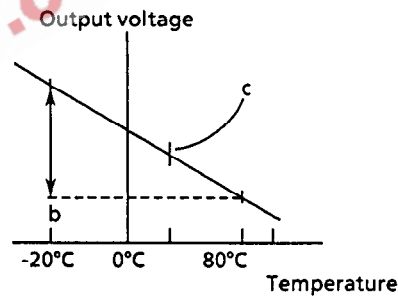

4. Output resistance ( $R_O$ )

$$R_O = \frac{\Delta V_O}{\Delta I_O}$$

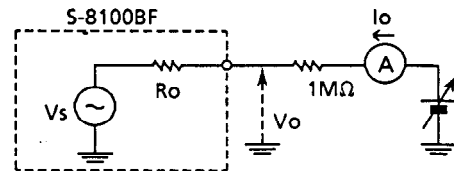

■ Application Temperature Switch

- Block Diagram

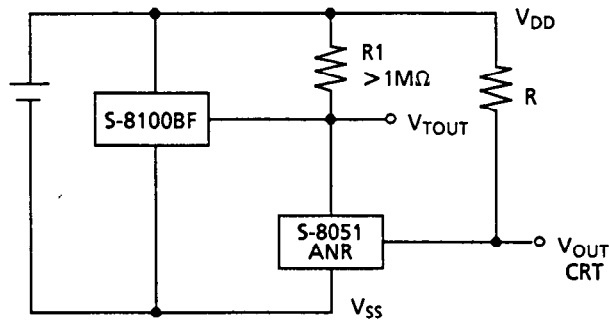
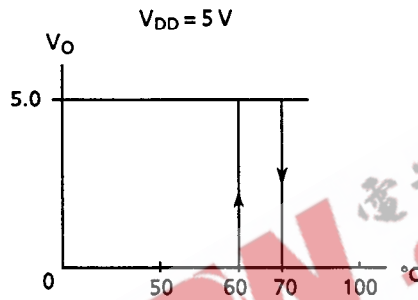

Figure 4

- Any desired temperature can be detected by combining the S-8100BF with a Seiko Instruments voltage detector and operating within the temperature range of the voltage detector.

- Output waveform



For the S-8051ANR, this becomes the 70°C temperature switch.

Figure 5

Note: Because the output impedance of the S-8100BF's CMOS output buffer is high, the output voltage level may fall because of contact with external circuits. If this happens, apply pull-up resistance, as shown in Figure 6.

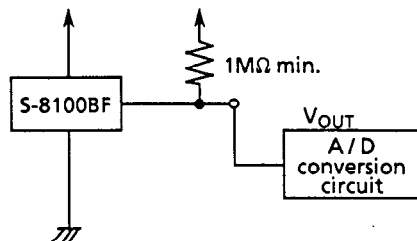
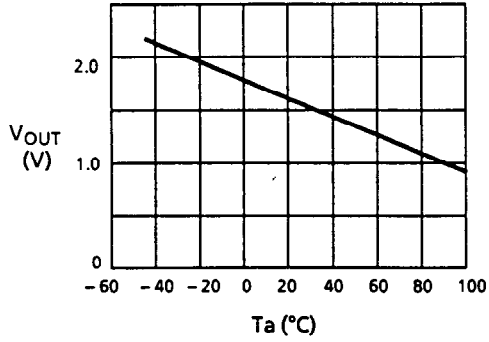

Figure 6

■ Characteristics

1. Ambient temperature ( $T_a$ )  
- Output voltage ( $V_{OUT}$ )



2. Ambient temperature ( $T_a$ )  
- Current consumption ( $I_{DD}$ )

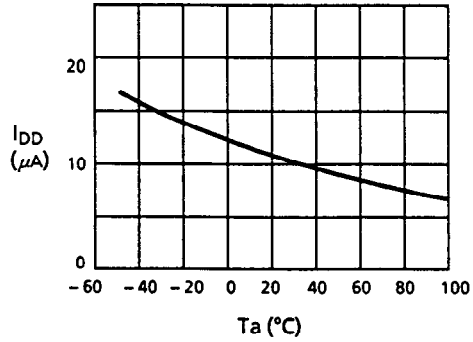

3. Power supply voltage ( $V_{DD}$ )  
- Output voltage ( $V_{OUT}$ )

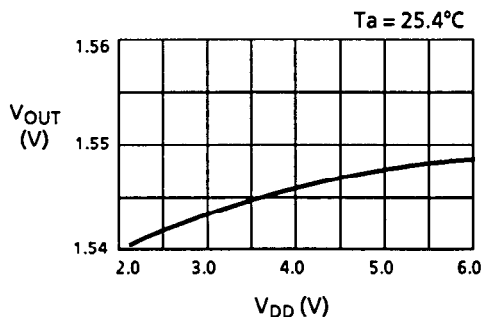

4. Power supply voltage ( $V_{DD}$ )  
- Current consumption ( $I_{DD}$ )

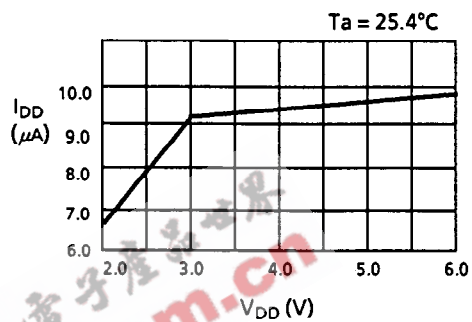

5. Heat response

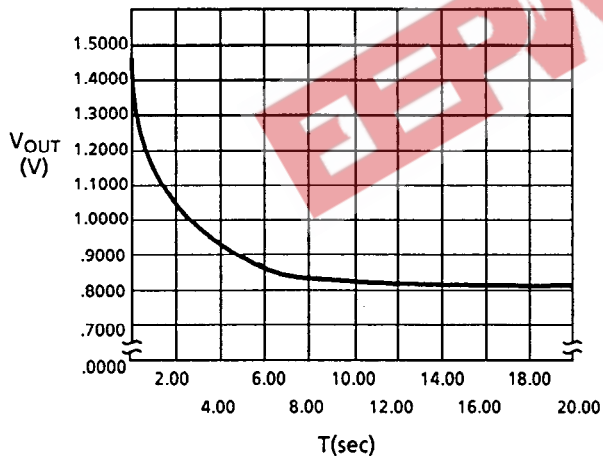

$25^\circ\text{C} \rightarrow 100^\circ\text{C}$

$T_1 = 8 \text{ sec}$

$T_2 = 2 \text{ sec}$

$T_1$ : Time required for output voltage to reach 95% of attainable voltage when a package is put into  $100^\circ\text{C}$  of water from  $25^\circ\text{C}$  of air.

$T_2$ : Time required for output voltage to reach 65% of attainable voltage when a package is put into  $100^\circ\text{C}$  of water from  $25^\circ\text{C}$  of air.