

FAST RECOVERY DIODES

Stud Version

Features

- High power FAST recovery diode series
- 1.5 to 2.0 μ s recovery time
- High voltage ratings up to 1600V
- High current capability
- Optimized turn on and turn off characteristics
- Low forward recovery
- Fast and soft reverse recovery
- Compression bonded encapsulation
- Stud version JEDEC DO-205AB (DO-9)
- Maximum junction temperature 125°C

250A

Typical Applications

- Snubber diode for GTO
- High voltage free-wheeling diode
- Fast recovery rectifier applications

Major Ratings and Characteristics

Parameters	SD253N/R	Units
$I_{F(AV)}$	250	A
@ T_C	85	°C
$I_{F(RMS)}$	392	A
I_{FSM} @ 50Hz	5350	A
@ 60Hz	5600	A
I^2t @ 50Hz	143	KA ² s
@ 60Hz	130	KA ² s
V_{RRM} range	400 to 1600	V
t_{rr} range	1.5 to 2.0	μ s
@ T_J	25	°C
T_J	- 40 to 125	°C



case style
DO-205AB (DO-9)

ELECTRICAL SPECIFICATIONS

Voltage Ratings

Type number	Voltage Code	V _{RRM} max. repetitive peak and off-state voltage V	V _{RSM} , maximum non-repetitive peak voltage V	I _{RRM} max. T _J = 125°C mA
SD253N/R..S15	04	400	500	35
	08	800	900	
	10	1000	1100	
SD253N/R..S20	12	1200	1300	
	14	1400	1500	
	16	1600	1700	

Forward Conduction

Parameter	SD253N/R	Units	Conditions
I _{F(AV)} Max. average forward current @ Case temperature	250	A	180° conduction, half sine wave.
	85	°C	
I _{F(RMS)} Max. RMS current	392	A	DC @ 74°C case temperature
I _{FSM} Max. peak, one-cycle non-repetitive forward current	5350	A	t = 10ms No voltage
	5600		t = 8.3ms reapplied
	4500		t = 10ms 100% V _{RRM}
	4710		t = 8.3ms reapplied
I ² t Maximum I ² t for fusing	143	KA ² s	t = 10ms No voltage
	130		t = 8.3ms reapplied
	101		t = 10ms 100% V _{RRM}
	92		t = 8.3ms reapplied
I ² /t Maximum I ² /t for fusing	1430	KA ² /s	t = 0.1 to 10ms, no voltage reapplied
V _{F(TO)1} Low level of threshold voltage	0.87	V	(16.7% x π x I _{F(AV)} < I < π x I _{F(AV)}), T _J = T _J max.
V _{F(TO)2} High level of threshold voltage	1.17		(I > π x I _{F(AV)}), T _J = T _J max.
r _{f1} Low level of forward slope resistance	0.62	mΩ	(16.7% x π x I _{F(AV)} < I < π x I _{F(AV)}), T _J = T _J max.
r _{f2} High level of forward slope resistance	0.29		(I > π x I _{F(AV)}), T _J = T _J max.
V _{FM} Max. forward voltage	1.38	V	I _{pk} = 785A, T _J = 25°C, t _p = 400 μs square pulse

Recovery Characteristics

Code	T _J = 25°C typical t _{rr} @ 25% I _{RRM} (μs)	Test conditions			Max. values @ T _J = 125°C			
		I _{pk} Square Pulse (A)	di/dt (A/μs)	V _r (V)	t _{rr} @ 25% I _{RRM} (μs)	Q _{rr} (μC)	I _{rr} (A)	
S15	1.5	750	25	-30	2.9	90	44	
S20	2.0				3.2	107	46	

Thermal and Mechanical Specification

Parameter	SD253N/R	Units	Conditions
T _J Max. operating temperature range	-40 to 125	°C	
T _{stg} Max. storage temperature range	-40 to 150		
R _{thJC} Max. thermal resistance, junction to case	0.115	K/W	DC operation
R _{thCS} Max. thermal resistance, case to heatsink	0.08		Mounting surface, smooth, flat and greased
T Mounting torque ± 10%	31	Nm	Not lubricated threads
	24.5		Lubricated threads
wt Approximate weight	250	g	
Case style	DO-205AB (DO-9)		See Outline Table

ΔR_{thJC} Conduction

(The following table shows the increment of thermal resistance R_{thJC} when devices operate at different conduction angles than DC)

Conduction angle	Sinusoidal conduction	Rectangular conduction	Units	Conditions
180°	0.010	0.008	K/W	T _J = T _J max.
120°	0.013	0.014		
90°	0.017	0.019		
60°	0.025	0.027		
30°	0.044	0.044		

Ordering Information Table

Device Code	
SD 25 3 R 16 S20 P B V	<div style="display: flex; justify-content: space-around; width: 100%;"> ①②③④⑤⑥⑦⑧⑨ </div>
1	- Diode
2	- Essential part number
3	- 3 = Fast recovery
4	- N = Stud Normal Polarity (Cathode to Stud) R = Stud Reverse Polarity (Anode to Stud)
5	- Voltage code: Code x 100 = V _{RRM} (see Voltage Ratings table)
6	- t _{rr} code (see Recovery Characteristics table)
7	- P = Stud base DO-205AB (DO-9) 3/4" 16UNF-2A M = Stud base DO-205AB (DO-9) M16 X 1.5
8	- B = Flag top terminals (for Cathode/ Anode Leads) S = Isolated lead with silicone sleeve (Red = Reverse Polarity; Blue = Normal Polarity) None = Not isolated lead
9	- V = Glass-metal seal

SD253N/R Series

Bulletin I2065 rev. A 09/94

Outline Table



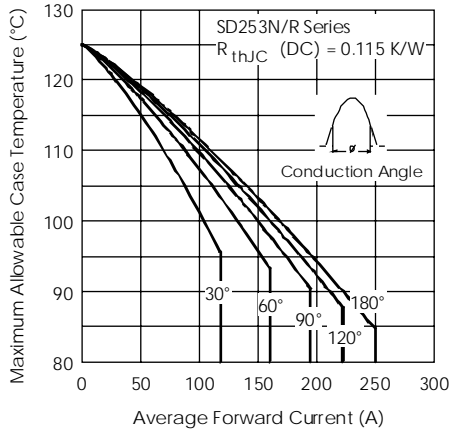

Fig. 1 - Current Ratings Characteristics

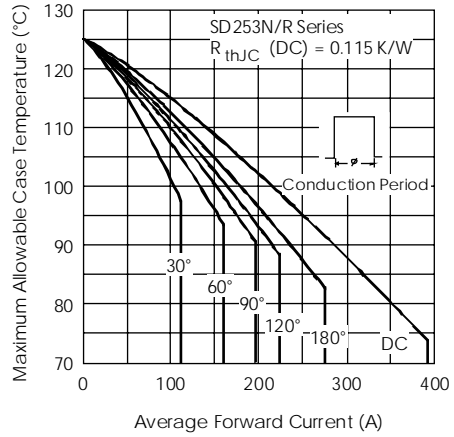

Fig. 2 - Current Ratings Characteristics

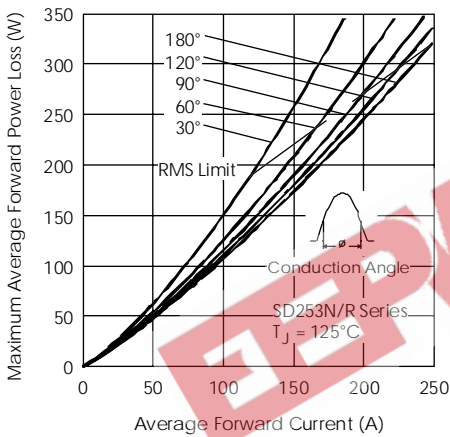

Fig. 3 - Forward Power Loss Characteristics

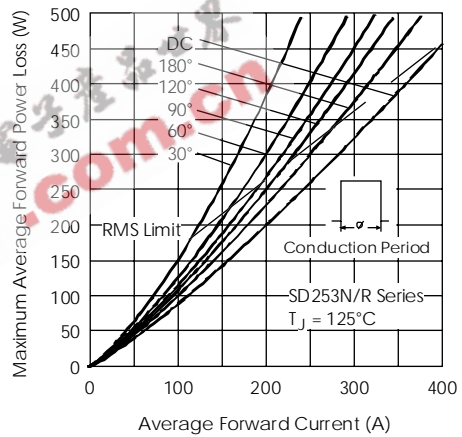

Fig. 4 - Forward Power Loss Characteristics

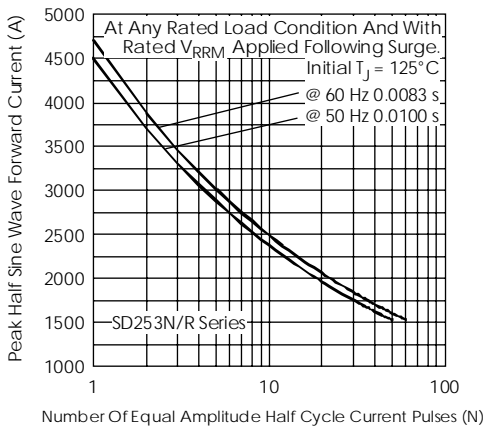

Fig. 5 - Maximum Non-repetitive Surge Current

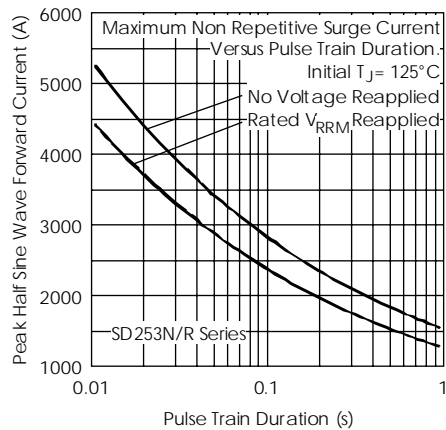

Fig. 6 - Maximum Non-repetitive Surge Current

SD253N/R Series

Bulletin I2065 rev. A 09/94

International
IRF Rectifier



Fig. 7 - Forward Voltage Drop Characteristics



Fig. 8 - Thermal Impedance Z_{thJC} Characteristic

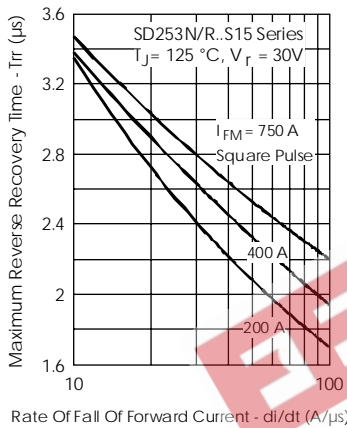

Fig. 9 - Recovery Time Characteristics

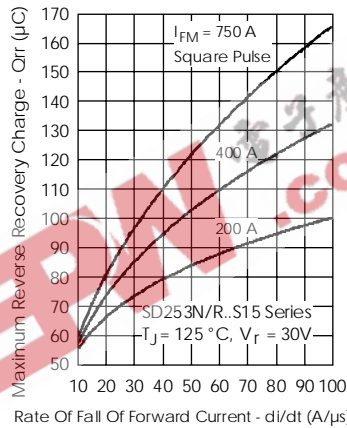

Fig. 10 - Recovery Charge Characteristics

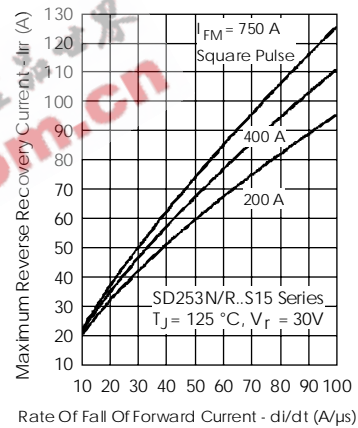

Fig. 11 - Recovery Current Characteristics

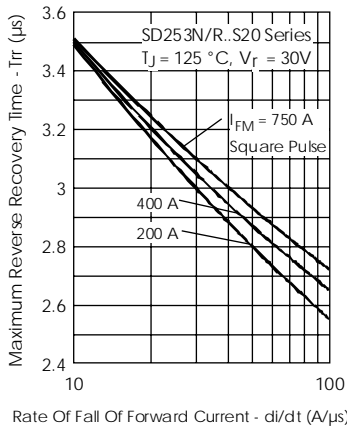

Fig. 12 - Recovery Time Characteristics

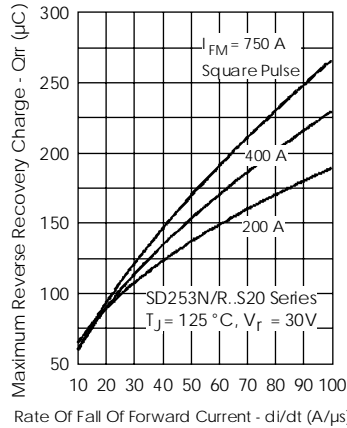

Fig. 13 - Recovery Charge Characteristics

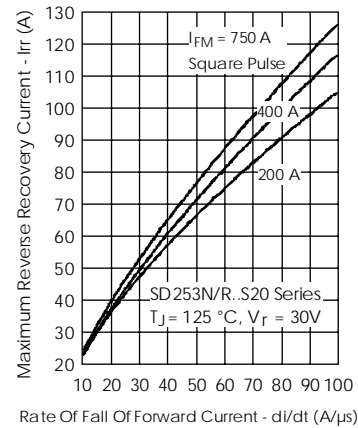

Fig. 14 - Recovery Current Characteristics



Fig. 15 - Maximum Total Energy Loss Per Pulse Characteristics

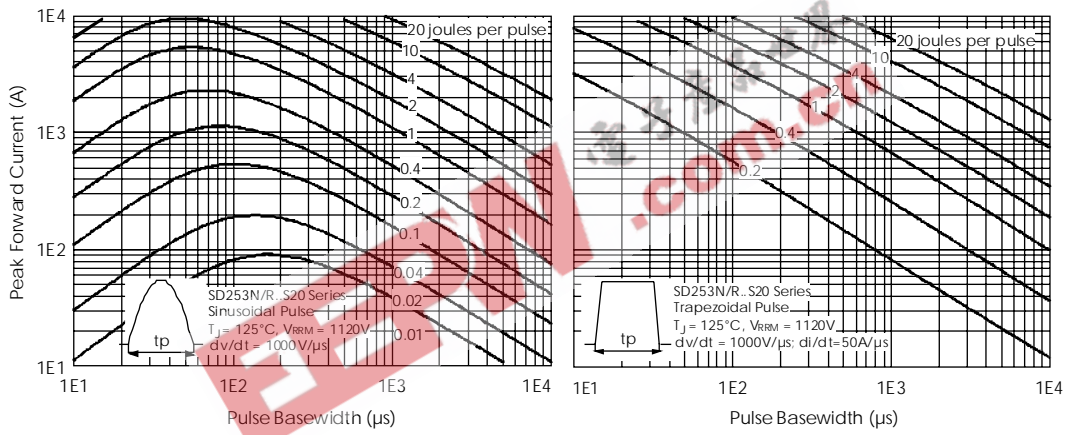

Fig. 16 - Maximum Total Energy Loss Per Pulse Characteristics