

Description

- Six sizes of shielded drum core inductors with low profiles (as low as 1.0mm) and high power density
- Inductance range from .47uH to 1000uH
- Current range from 6.00 to 0.088 Amps
- Ferrite shielded, low EMI

Applications

- Digital cameras, CD players, cellular phones, and PDAs
- PCMCIA cards
- GPS systems

Environmental Data

- Storage temperature range: -40C to +125C
- Operating ambient temperature range: -40C to +85C (range is application specific). Temperature rise is approximately 40C at rated rms current
- Infrared reflow temperature: +240C for 30 seconds maximum

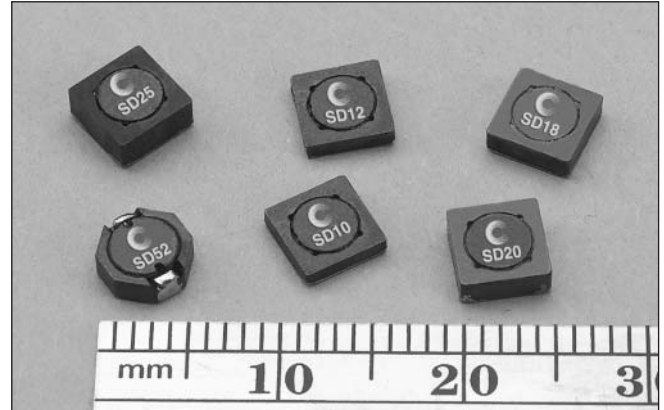

Packaging

- Supplied in tape and reel packaging, 3800 (SD10, SD12 and SD18), 2900 (SD20 and SD25), and 3500 (SD52) per reel

Part Number	Rated Inductance (µH)	OCL (1) +/-20% (µH)	Part Marking	I _{rms} (2) Amperes	I _{sat} (3) Amperes	DCR (4) (Ω) Typ.	Volt u-sec Typ.
SD10-R47	0.470	0.453	A	2.59	3.54	0.0249	2.1
SD10-1R0	1.00	1.119	B	1.93	2.25	0.0448	3.3
SD10-1R5	1.50	1.563	C	1.60	1.91	0.0653	3.9
SD10-2R2	2.20	2.081	D	1.35	1.65	0.0912	4.5
SD10-3R3	3.30	3.339	E	1.24	1.31	0.1078	5.7
SD10-4R7	4.70	4.893	F	1.04	1.08	0.1535	6.9
SD10-6R2	6.20	6.743	G	0.94	0.92	0.1870	8.1
SD10-8R2	8.20	8.889	H	0.800	0.800	0.2607	9.3
SD10-100	10.0	10.07	J	0.760	0.752	0.2888	9.9
SD10-150	15.0	15.55	K	0.613	0.605	0.4429	12.3
SD10-220	22.0	22.21	L	0.498	0.506	0.6718	14.7
SD10-330	33.0	32.20	M	0.412	0.420	0.9807	17.7
SD10-470	47.0	46.63	N	0.337	0.349	1.47	21.3
SD10-680	68.0	70.01	O	0.301	0.285	1.84	26.1
SD10-820	82.0	83.48	P	0.258	0.261	2.50	28.5
SD10-101	100	102.0	Q	0.225	0.236	3.29	31.5
SD10-151	150	149.2	R	0.200	0.195	4.15	38.1
SD10-221	220	222.2	S	0.161	0.160	6.41	46.5
SD10-331	330	330.4	T	0.130	0.131	9.83	56.7
SD10-471	470	468.3	U	0.117	0.110	12.10	67.5
SD12-R47	0.470	0.490	A	3.19	3.86	0.0246	2.84
SD12-1R2	1.20	1.21	B	2.62	2.45	0.0366	4.47
SD12-1R5	1.50	1.69	C	2.19	2.08	0.0521	5.28
SD12-2R2	2.20	2.25	D	1.83	1.80	0.0747	6.09
SD12-3R3	3.30	3.61	E	1.55	1.42	0.1043	7.71
SD12-4R7	4.70	4.41	F	1.46	1.29	0.1177	8.53
SD12-6R2	6.20	6.25	G	1.21	1.08	0.1699	10.15
SD12-8R2	8.20	8.41	H	1.02	0.931	0.2399	11.77
SD12-100	10.0	10.89	J	0.938	0.818	0.2844	13.40
SD12-150	15.0	15.21	K	0.782	0.692	0.4089	15.83
SD12-220	22.0	22.09	L	0.628	0.574	0.6338	19.08
SD12-330	33.0	32.49	M	0.519	0.474	0.9289	23.14
SD12-470	47.0	47.61	N	0.428	0.391	1.37	28.01
SD12-680	68.0	68.89	O	0.341	0.325	2.16	33.70
SD12-820	82.0	82.81	P	0.326	0.297	2.36	36.95
SD12-101	100	98.0	Q	0.308	0.273	2.64	40.19
SD12-151	150	151.3	R	0.251	0.220	3.96	49.94

(1) Open Circuit Inductance Test Parameters: 100KHz, 0.25Vrms, 0.0A_{dc}.

(2) RMS current for an approximate ΔT of 40°C without core loss. It is recommended that the temperature of the part not exceed 125°C.

(3) Peak current for approximate 30% roll off at 20°C.

(4) DCR limits @ 20°C.

(5) Applied Volt-Time product (V-uS) across the inductor at 100kHz necessary to generate a core loss equal to 10% of the total losses for 40°C temperature rise.

Part Number	Rated Inductance (μH)	OCL (1) +/-20% (μH)	Part Marking	I _{rms} (2) Amperes	I _{sat} (3) Amperes	DCR (4) (Ω) Typ.	Volt u-sec Typ.
SD12-221	220	222.0	S	0.229	0.181	4.76	60.49
SD12-331	330	334.9	T	0.186	0.148	7.25	74.30
SD12-471	470	462.3	U	0.167	0.126	8.95	87.29
SD12-681	680	670.8	V	0.149	0.104	11.30	105
SD12-821	820	800.9	W	0.129	0.095	14.93	115
SD12-102	1000	992.3	X	0.121	0.086	17.20	128
SD18-R47	0.47	0.49	A	3.58	4.63	0.0201	2.35
SD18-R82	0.82	0.81	B	3.24	3.60	0.0247	3.02
SD18-1R2	1.20	1.21	C	2.97	2.95	0.0294	3.70
SD18-1R5	1.50	1.69	D	2.73	2.49	0.0345	4.37
SD18-2R2	2.20	2.25	E	2.55	2.16	0.0398	5.04
SD18-3R3	3.30	3.61	F	2.07	1.71	0.0605	6.38
SD18-4R7	4.70	4.41	G	1.77	1.54	0.0824	7.06
SD18-6R2	6.20	6.25	H	1.61	1.30	0.1000	8.40
SD18-8R2	8.20	8.41	J	1.38	1.12	0.1351	9.74
SD18-100	10.0	10.89	K	1.28	0.982	0.1584	11.09
SD18-150	15.0	15.21	L	1.06	0.831	0.2278	13.10
SD18-220	22.0	22.09	M	0.876	0.689	0.3366	15.79
SD18-330	33.0	32.49	N	0.715	0.568	0.5057	19.15
SD18-470	47.0	47.61	O	0.578	0.470	0.7732	23.18
SD18-680	68.0	68.89	P	0.514	0.390	0.9798	27.89
SD18-820	82.0	82.81	Q	0.446	0.356	1.30	30.58
SD18-101	100	102.01	R	0.419	0.321	1.47	33.94
SD18-151	150	151.29	S	0.345	0.263	2.18	41.33
SD18-221	220	222.01	T	0.296	0.217	2.95	50.06
SD18-331	330	334.89	U	0.248	0.177	4.20	61.49
SD18-471	470	479.61	V	0.201	0.148	6.39	73.58
SD18-681	680	681.21	W	0.167	0.124	9.28	87.70
SD18-821	820	823.69	X	0.145	0.113	12.35	96.43
SD18-102	1000	1004	Y	0.136	0.102	14.01	107
SD20-R47	0.47	0.490	A	3.59	4.00	0.0200	2.28
SD20-1R2	1.20	1.21	B	3.07	2.55	0.0275	3.58
SD20-1R5	1.50	1.69	C	2.88	2.15	0.0312	4.23
SD20-2R2	2.20	2.25	D	2.45	1.87	0.0429	4.88
SD20-3R3	3.30	3.61	E	2.17	1.47	0.0547	6.18
SD20-4R7	4.70	4.41	F	2.05	1.33	0.0612	6.83
SD20-6R2	6.20	6.25	G	1.89	1.12	0.0720	8.13
SD20-8R2	8.20	8.41	H	1.61	0.966	0.1000	9.43
SD20-100	10.0	9.61	J	1.53	0.903	0.1100	10.08
SD20-150	15.0	15.21	K	1.25	0.718	0.1655	12.68
SD20-220	22.0	22.09	L	1.12	0.596	0.2053	15.28
SD20-330	33.0	32.49	M	0.913	0.491	0.3100	18.53
SD20-470	47.0	47.61	N	0.745	0.406	0.4650	22.43
SD20-680	68.0	68.89	O	0.610	0.337	0.6947	26.98
SD20-820	82.0	82.81	P	0.576	0.308	0.7785	29.58
SD20-101	100	98.01	Q	0.495	0.283	1.06	32.18
SD20-151	150	151.3	R	0.435	0.228	1.37	39.98
SD20-221	220	222.0	S	0.356	0.188	2.04	48.43
SD20-331	330	327.6	T	0.294	0.155	2.99	58.83
SD20-471	470	470.9	U	0.263	0.129	3.74	70.53
SD20-681	680	681.2	V	0.216	0.107	5.56	84.83
SD20-821	820	823.7	W	0.204	0.098	6.22	93.28
SD20-102	1000	1004.9	X	0.172	0.088	8.73	103
SD25-R47	0.47	0.466	A	3.88	6.00	0.0177	2.13
SD25-R82	0.82	0.770	B	3.58	4.67	0.0208	2.74
SD25-1R2	1.20	1.15	C	3.33	3.81	0.0240	3.34
SD25-1R5	1.50	1.61	D	3.12	3.23	0.0274	3.95
SD25-2R2	2.20	2.14	E	2.93	2.80	0.0311	4.56

(1) Open Circuit Inductance Test Parameters: 100KHz, 0.25Vrms, 0.0Aac.
(2) RMS current for an approximate ΔT of 40°C without core loss. It is recommended that the temperature of the part not exceed 125°C.
(3) Peak current for approximate 30% roll off at 20°C.

(4) DCR limits @ 20°C.
(5) Applied Volt-Time product (V-uS) across the inductor at 100kHz necessary to generate a core loss equal to 10% of the total losses for 40°C temperature rise.

Part Number	Rated Inductance (μH)	OCL (1) +/-20% (μH)	Part Marking	I _{rms} (2) Amperes	I _{sat} (3) Amperes	DCR (4) (Ω) Typ.	Volt u-sec Typ.
SD25-3R3	3.30	3.43	F	2.64	2.21	0.0384	5.78
SD25-4R7	4.70	5.03	G	2.39	1.83	0.0467	6.99
SD25-6R8	6.80	6.93	H	2.19	1.56	0.0556	8.21
SD25-8R2	8.20	7.99	J	1.92	1.45	0.0724	8.82
SD25-100	10.0	10.35	K	1.80	1.27	0.0824	10.03
SD25-150	15.0	14.45	L	1.67	1.08	0.0956	11.86
SD25-220	22.0	22.81	M	1.34	0.857	0.1478	14.90
SD25-330	33.0	33.07	N	1.11	0.711	0.2149	17.94
SD25-470	47.0	47.89	O	0.919	0.592	0.3156	21.58
SD25-680	68.0	68.64	P	0.741	0.482	0.4850	25.84
SD25-820	82.0	82.17	Q	0.713	0.441	0.5242	28.27
SD25-101	100	100.79	R	0.670	0.398	0.5937	31.31
SD25-151	150	148.4	S	0.553	0.328	0.8723	38.00
SD25-221	220	222.4	T	0.446	0.268	1.34	46.51
SD25-331	330	332.2	U	0.359	0.219	2.07	56.85
SD25-471	470	472.4	V	0.293	0.184	3.10	67.79
SD25-681	680	677.2	W	0.262	0.154	3.88	81.17
SD25-821	820	826.7	X	0.230	0.139	5.04	89.68
SD25-102	1000	1003.4	Y	0.216	0.126	5.70	98.80

(1) Open Circuit Inductance Test Parameters: 100kHz, 0.25V_{rms}, 0.0Adc.
 (2) RMS current for an approximate ΔT of 40°C without core loss. It is recommended that the temperature of the part not exceed 125°C.
 (3) Peak current for approximate 30% roll off at 20°C.

(4) DCR limits @ 20°C.
 (5) Applied Volt-Time product (V-uS) across the inductor at 100kHz necessary to generate a core loss equal to 10% of the total losses for 40°C temperature rise.

Mechanical Diagrams

SD Series

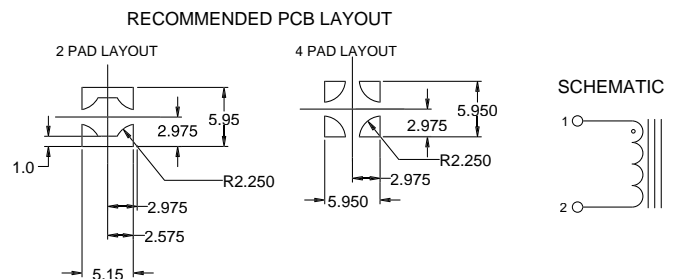
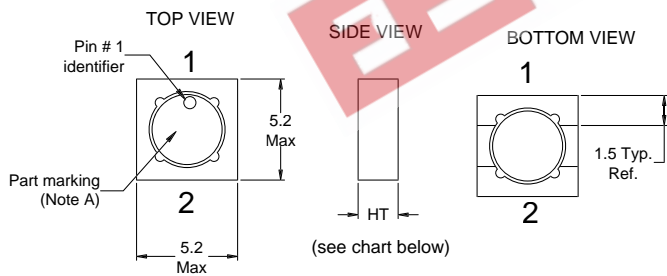

Series	HT
SD10	1.0mm max
SD12	1.2mm max
SD18	1.8mm max
SD20	2.0mm max
SD25	2.5mm max

A) Part Marking: Line 1: (1st digit indicates the inductance value per part marking designator in chart above)
 (2nd digit is a bi-weekly production date code)
 (3rd digit is the last digit of the year produced)
 Line 2: 12 (indicates the product size code)

Packaging Information

SD10 Series

A₀=5.45mm
B₀=5.45mm
K₀=1.20mm

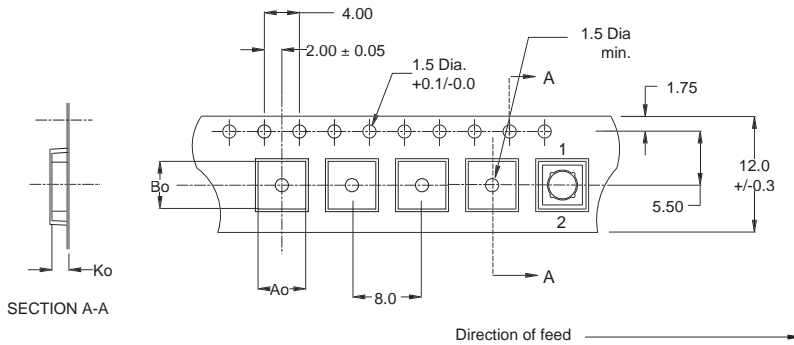

ACTUAL SIZE
SD10

Parts packaged on 13" Diameter reel,
3,800 parts per reel.

SD12/18 Series

A₀=5.45mm
B₀=5.45mm
K₀=2.00mm

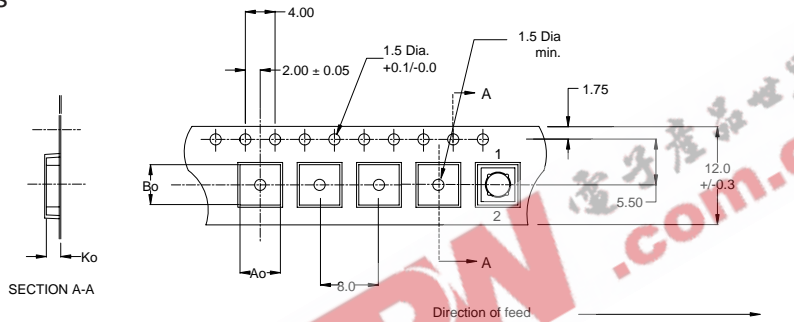

ACTUAL SIZE
SD12

ACTUAL SIZE
SD18

Parts packaged on 13" Diameter reel,
3,800 parts per reel.

SD20/25 Series

A₀=5.45mm
B₀=5.45mm
K₀=2.70mm

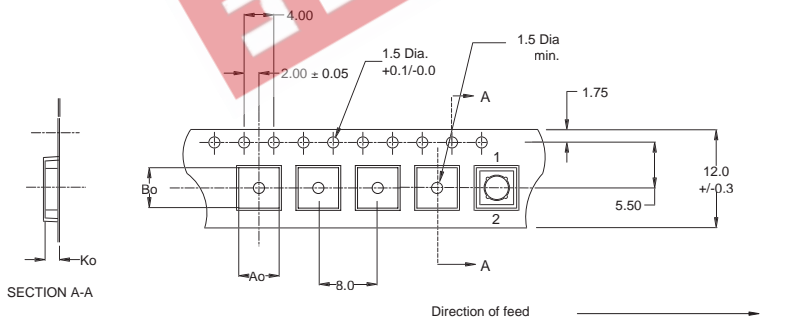

ACTUAL SIZE
SD20

ACTUAL SIZE
SD25

Parts packaged on 13" Diameter reel,
2,900 parts per reel.

Dimensions are in millimeters.

DC Current vs. Temperature

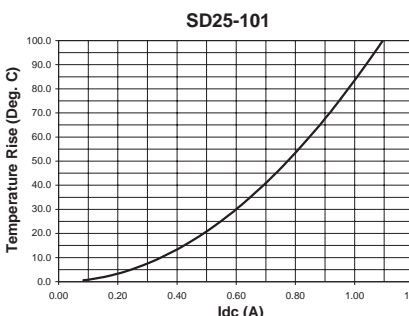
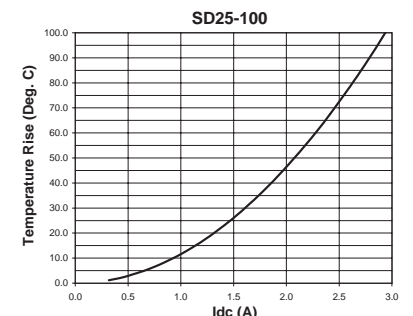
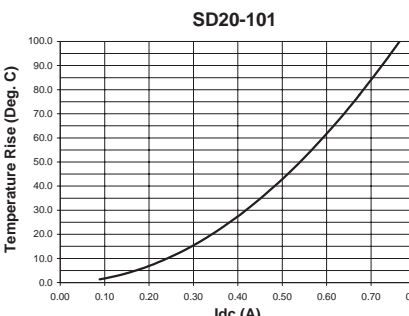
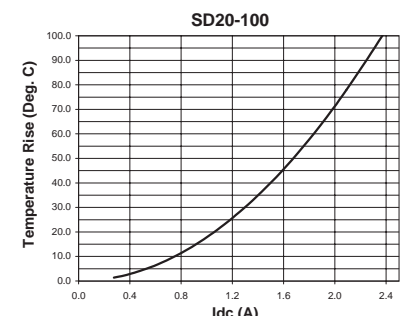
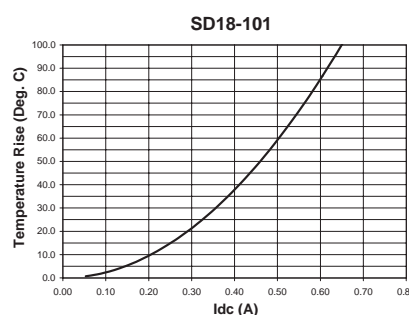
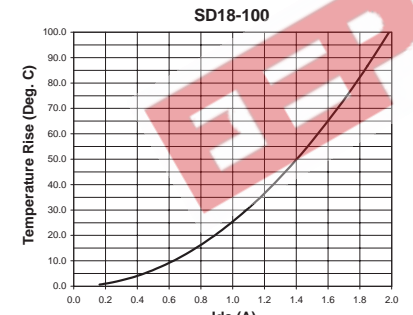
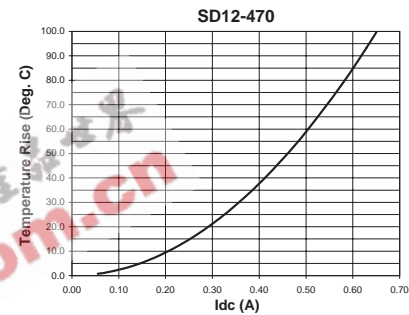
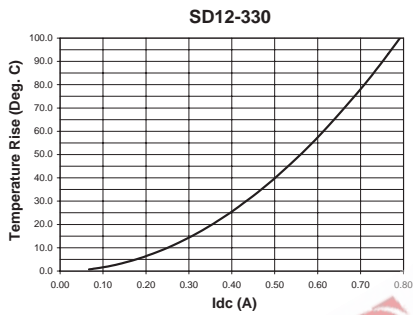
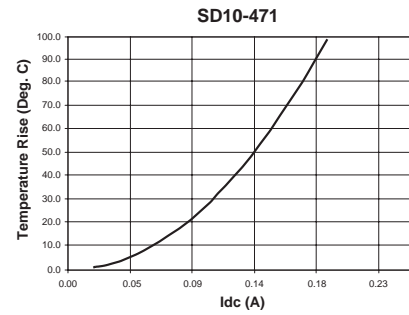
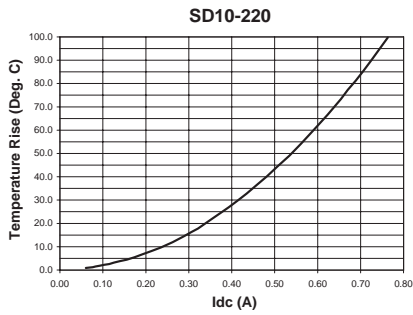

Rolloff

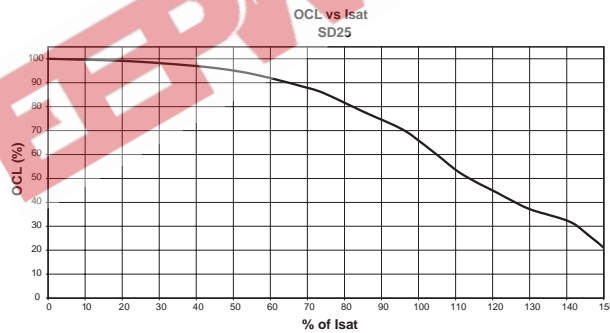
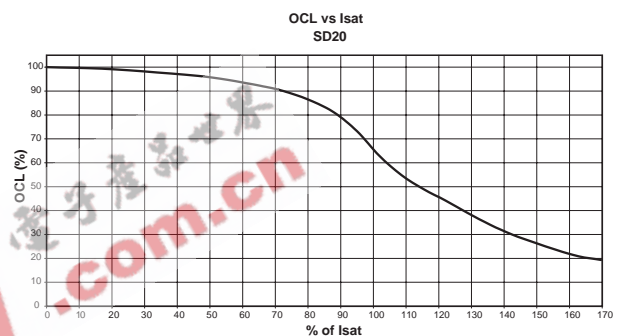
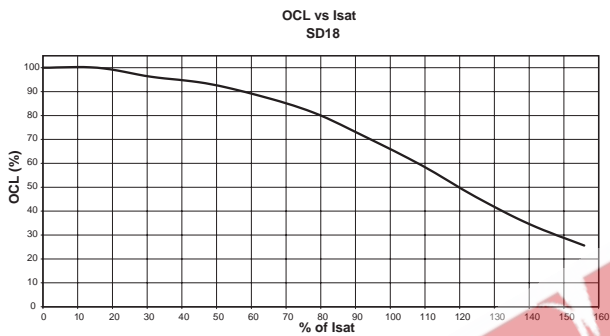
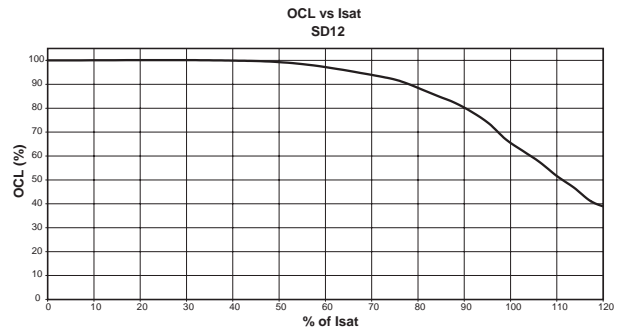
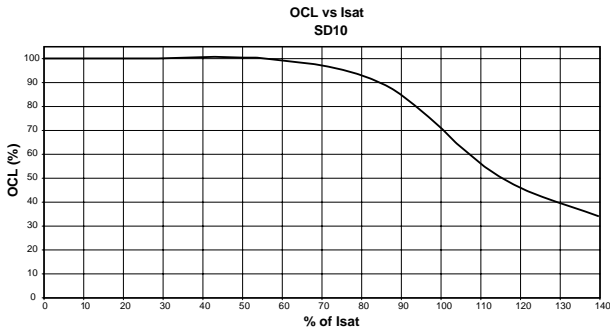

Core Loss

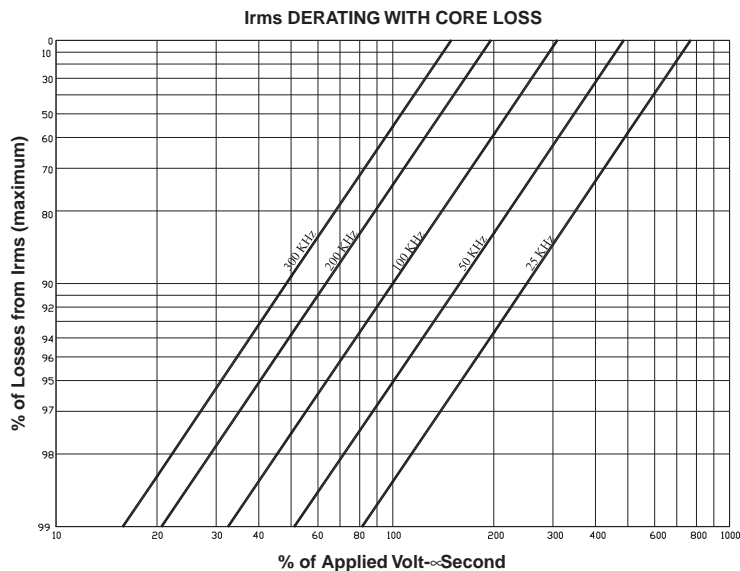

Part Number	Rated Inductance (μH)	OCL (1) +/-20% (μH)	Part Marking	I _{rms} (2) Amperes	I _{sat} (3) Amperes	DCR (4) (Ω) Typ.	Volt u-sec Typ.
SD52-1R2	1.20	1.20	A	2.33	3.14	0.0279	1.49
SD52-2R2	2.20	2.20	B	1.98	2.30	0.0385	2.03
SD52-3R5	3.50	3.50	C	1.73	1.82	0.0503	2.57
SD52-4R7	4.70	4.70	D	1.63	1.64	0.0568	2.84
SD52-6R8	6.80	6.80	E	1.39	1.28	0.0777	3.65
SD52-100	10.0	10.0	F	1.11	1.11	0.1215	4.19
SD52-150	15.0	15.0	G	0.97	0.88	0.1618	5.27
SD52-220	22.0	22.0	H	0.86	0.73	0.2042	6.35
SD52-270	27.0	27.0	J	0.73	0.65	0.2864	7.16
SD52-330	33.0	33.0	K	0.70	0.61	0.3074	7.70
SD52-470	47.0	47.0	L	0.58	0.50	0.4465	9.32
SD52-680	68.0	68.0	M	0.47	0.42	0.6829	11.21
SD52-101	100	100	N	0.39	0.35	1.0000	13.37

(1) Open Circuit Inductance Test Parameters: 100KHz, 0.25Vrms, 0.0A_{dc}.
 (2) RMS current for an approximate ΔT of 40°C without core loss. It is recommended that the temperature of the part not exceed 125°C.
 (3) Peak current for approximate 30% roll off at 20°C.

(4) DCR limits @ 20°C.
 (5) Applied Volt-Time product (V-uS) across the inductor at 100kHz necessary to generate a core loss equal to 10% of the total losses for 40°C temperature rise.

Mechanical Diagrams

SD52 Series

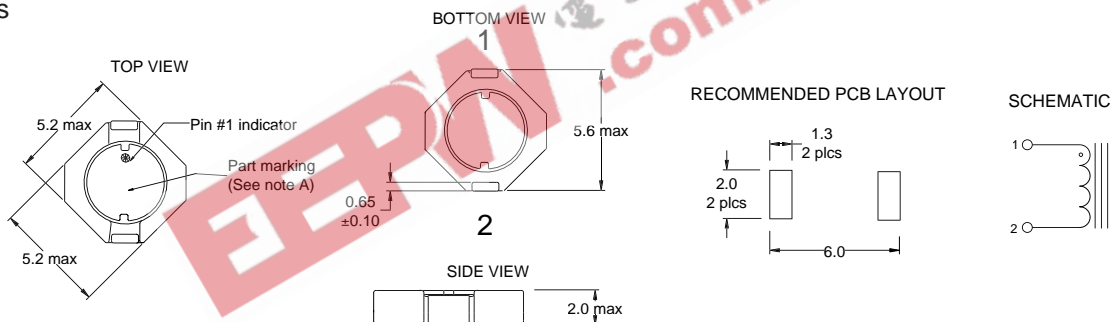

A) Part Marking: Line 1: (1st digit indicates the inductance value per part marking designator in chart above)
 (2nd digit is a bi-weekly production date code)
 (3rd digit is the last digit of the year produced)
 Line 2: 12 (indicates the product size code)

Packaging Information

SD52 Series

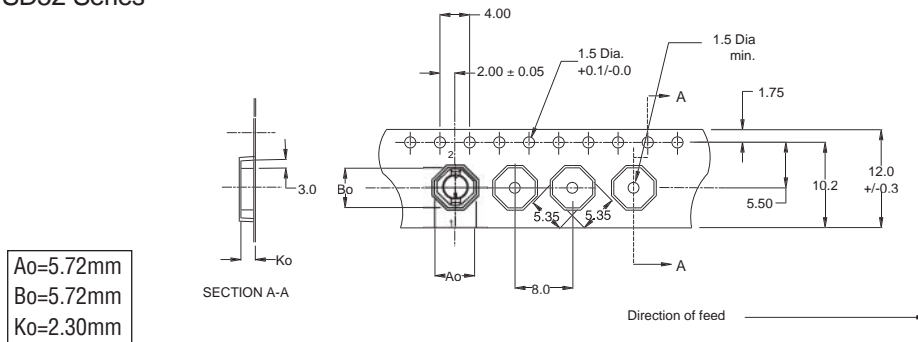

A₀=5.72mm
 B₀=5.72mm
 K₀=2.30mm

ACTUAL SIZE
SD52

Parts packaged on 13" Diameter reel,
3,500 parts per reel.

Dimensions are in millimeters.

DC Current vs. Temperature

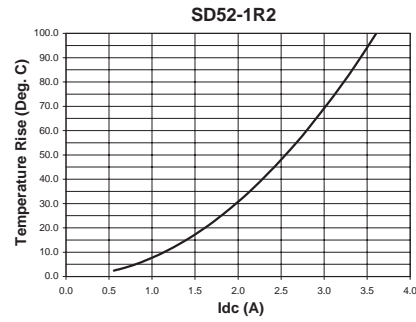
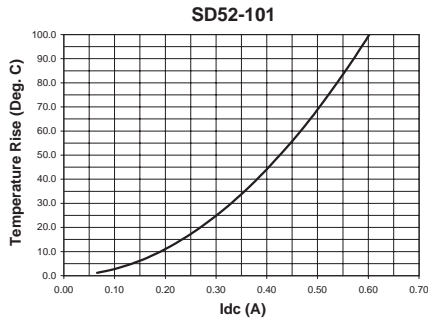

Rolloff

