

FAST RECOVERY DIODES

Stud Version

Features

- High power FAST recovery diode series
- 1.5 to 2.0 μ s recovery time
- High voltage ratings up to 1600V
- High current capability
- Optimized turn on and turn off characteristics
- Low forward recovery
- Fast and soft reverse recovery
- Compression bonded encapsulation
- Stud version JEDEC DO-205AB (DO-9)
- Maximum junction temperature 125°C

250A

Typical Applications

- Snubber diode for GTO
- High voltage free-wheeling diode
- Fast recovery rectifier applications

Major Ratings and Characteristics

| Parameters | SD253N/R | Units |
|------------------|-------------|-------------------|
| $I_{F(AV)}$ | 250 | A |
| @ T_C | 85 | °C |
| $I_{F(RMS)}$ | 392 | A |
| I_{FSM} @ 50Hz | 5350 | A |
| @ 60Hz | 5600 | A |
| I^2t @ 50Hz | 143 | KA ² s |
| @ 60Hz | 130 | KA ² s |
| V_{RRM} range | 400 to 1600 | V |
| t_{rr} range | 1.5 to 2.0 | μ s |
| @ T_J | 25 | °C |
| T_J | - 40 to 125 | °C |



case style
DO-205AB (DO-9)

SD253N/R Series

Bulletin I2065 rev. A 09/94

International
IR Rectifier

ELECTRICAL SPECIFICATIONS

Voltage Ratings

| Type number | Voltage Code | V_{RRM} max. repetitive peak and off-state voltage V | V_{RSM} , maximum non-repetitive peak voltage V | I_{RRM} max. $T_J = 125^\circ\text{C}$ mA |
|---------------|--------------|---|--|---|
| SD253N/R..S15 | 04 | 400 | 500 | 35 |
| | 08 | 800 | 900 | |
| | 10 | 1000 | 1100 | |
| SD253N/R..S20 | 12 | 1200 | 1300 | |
| | 14 | 1400 | 1500 | |
| | 16 | 1600 | 1700 | |

Forward Conduction

| Parameter | SD253N/R | Units | Conditions |
|---|----------|--------------------|---|
| $I_{F(AV)}$ Max. average forward current @ Case temperature | 250 | A | 180° conduction, half sine wave. |
| | 85 | °C | |
| $I_{F(RMS)}$ Max. RMS current | 392 | A | DC @ 74°C case temperature |
| I_{FSM} Max. peak, one-cycle non-repetitive forward current | 5350 | A | t = 10ms No voltage |
| | 5600 | | t = 8.3ms reapplied |
| | 4500 | | t = 10ms 100% V_{RRM} |
| | 4710 | | t = 8.3ms reapplied |
| I^2t Maximum I^2t for fusing | 143 | KA ² s | t = 10ms No voltage |
| | 130 | | t = 8.3ms reapplied |
| | 101 | | t = 10ms 100% V_{RRM} |
| | 92 | | t = 8.3ms reapplied |
| $I^2\sqrt{t}$ Maximum $I^2\sqrt{t}$ for fusing | 1430 | KA ² √s | t = 0.1 to 10ms, no voltage reapplied |
| $V_{F(TO)1}$ Low level of threshold voltage | 0.87 | V | (16.7% × π × $I_{F(AV)}$) < I < π × $I_{F(AV)}$, $T_J = T_J$ max. |
| $V_{F(TO)2}$ High level of threshold voltage | 1.17 | | (I > π × $I_{F(AV)}$), $T_J = T_J$ max. |
| r_{f1} Low level of forward slope resistance | 0.62 | mΩ | (16.7% × π × $I_{F(AV)}$) < I < π × $I_{F(AV)}$, $T_J = T_J$ max. |
| r_{f2} High level of forward slope resistance | 0.29 | | (I > π × $I_{F(AV)}$), $T_J = T_J$ max. |
| V_{FM} Max. forward voltage | 1.38 | V | $I_{pk} = 785\text{A}$, $T_J = 25^\circ\text{C}$, $t_p = 400\ \mu\text{s}$ square pulse |

Recovery Characteristics

| Code | $T_J = 25^\circ\text{C}$ typical t_{rr} @ 25% I_{RRM} (μs) | Test conditions | | | Max. values @ $T_J = 125^\circ\text{C}$ | | | |
|------|---|---------------------------------|-----------------|--------------|---|------------------|-----------------|--|
| | | I_{pk} Square Pulse (A) | di/dt (A/μs) | V_r (V) | t_{rr} @ 25% I_{RRM} (μs) | Q_{rr} (μC) | I_{rr} (A) | |
| S15 | 1.5 | 750 | 25 | -30 | 2.9 | 90 | 44 | |
| S20 | 2.0 | | | | 3.2 | 107 | 46 | |

Thermal and Mechanical Specification

| Parameter | SD253N/R | Units | Conditions |
|---|-----------------|-------|--|
| T _J Max. operating temperature range | -40 to 125 | °C | |
| T _{stg} Max. storage temperature range | -40 to 150 | | |
| R _{thJC} Max. thermal resistance, junction to case | 0.115 | K/W | DC operation |
| R _{thCS} Max. thermal resistance, case to heatsink | 0.08 | | Mounting surface, smooth, flat and greased |
| T Mounting torque ± 10% | 31 | Nm | Not lubricated threads |
| | 24.5 | | Lubricated threads |
| wt Approximate weight | 250 | g | |
| Case style | DO-205AB (DO-9) | | See Outline Table |

ΔR_{thJC} Conduction

(The following table shows the increment of thermal resistance R_{thJC} when devices operate at different conduction angles than DC)

| Conduction angle | Sinusoidal conduction | Rectangular conduction | Units | Conditions |
|------------------|-----------------------|------------------------|-------|--------------------------------------|
| 180° | 0.010 | 0.008 | K/W | T _J = T _J max. |
| 120° | 0.013 | 0.014 | | |
| 90° | 0.017 | 0.019 | | |
| 60° | 0.025 | 0.027 | | |
| 30° | 0.044 | 0.044 | | |

Ordering Information Table

| Device Code | |
|-------------|---|
| SD | 25 3 R 16 S20 P B V |
| ① | ② ③ ④ ⑤ ⑥ ⑦ ⑧ ⑨ |
| 1 | - Diode |
| 2 | - Essential part number |
| 3 | - 3 = Fast recovery |
| 4 | - N = Stud Normal Polarity (Cathode to Stud) R = Stud Reverse Polarity (Anode to Stud) |
| 5 | - Voltage code: Code x 100 = V _{RRM} (see Voltage Ratings table) |
| 6 | - t _{rr} code (see Recovery Characteristics table) |
| 7 | - P = Stud base DO-205AB (DO-9) 3/4" 16UNF-2A M = Stud base DO-205AB (DO-9) M16 X 1.5 |
| 8 | - B = Flag top terminals (for Cathode/ Anode Leads) S = Isolated lead with silicone sleeve (Red = Reverse Polarity; Blue = Normal Polarity) None = Not isolated lead |
| 9 | - V = Glass-metal seal |

SD253N/R Series

Bulletin I2065 rev. A 09/94

Outline Table



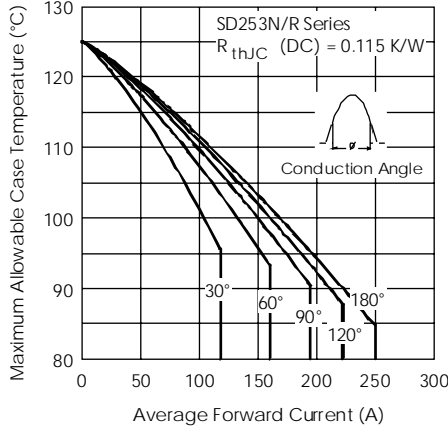

Fig. 1 - Current Ratings Characteristics

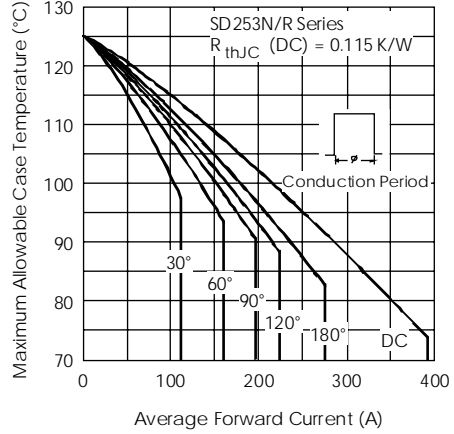

Fig. 2 - Current Ratings Characteristics

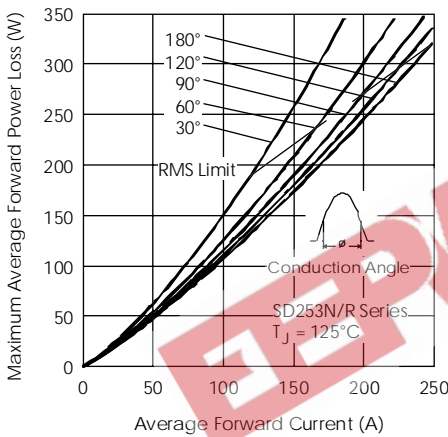

Fig. 3 - Forward Power Loss Characteristics

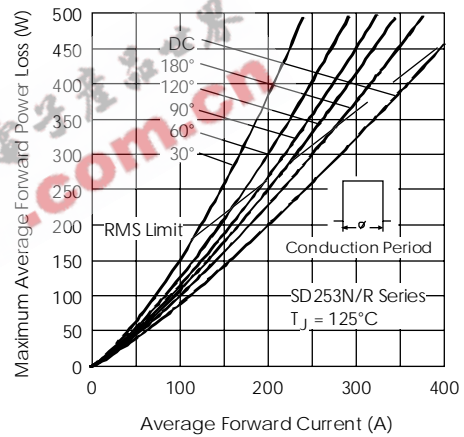

Fig. 4 - Forward Power Loss Characteristics

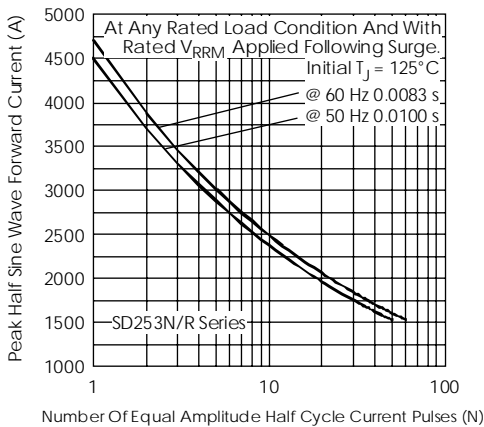

Fig. 5 - Maximum Non-repetitive Surge Current

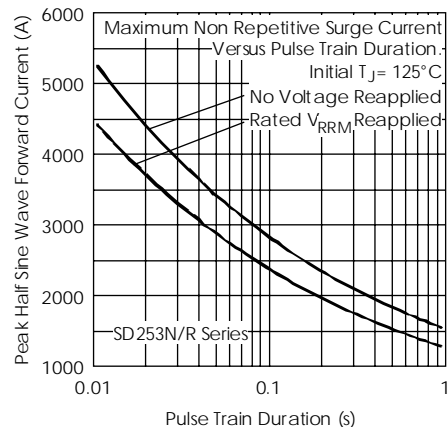

Fig. 6 - Maximum Non-repetitive Surge Current

SD253N/R Series

Bulletin I2065 rev. A 09/94

International
IRF Rectifier



Fig. 7 - Forward Voltage Drop Characteristics



Fig. 8 - Thermal Impedance Z_{thJC} Characteristic

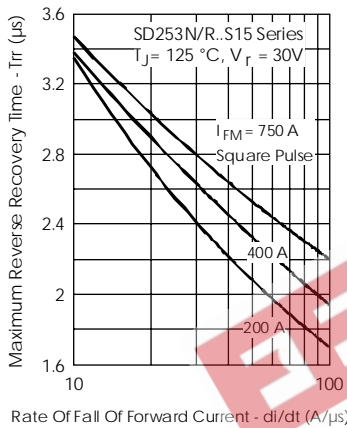

Fig. 9 - Recovery Time Characteristics

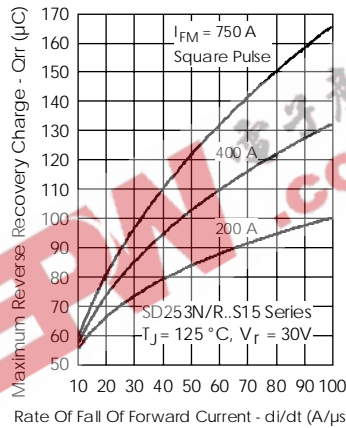

Fig. 10 - Recovery Charge Characteristics

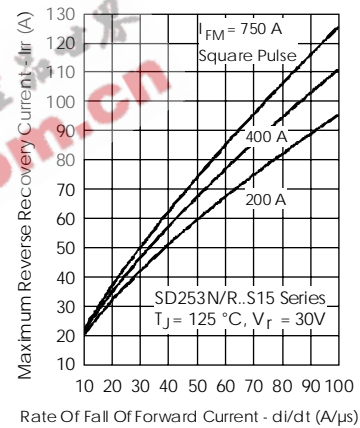

Fig. 11 - Recovery Current Characteristics

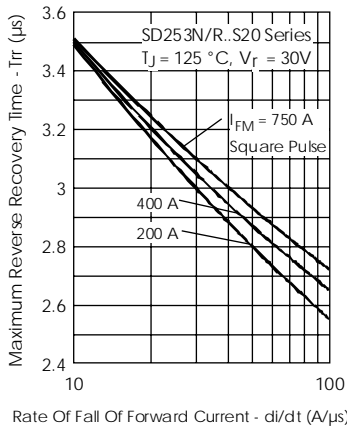

Fig. 12 - Recovery Time Characteristics

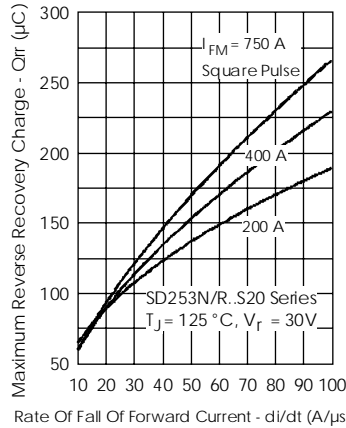

Fig. 13 - Recovery Charge Characteristics

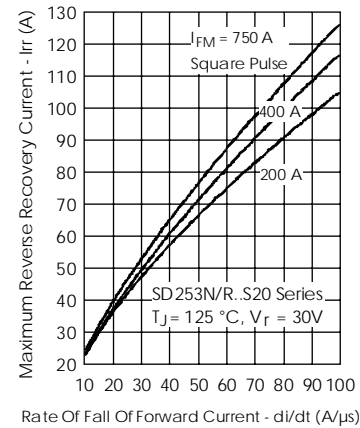

Fig. 14 - Recovery Current Characteristics



Fig. 15 - Maximum Total Energy Loss Per Pulse Characteristics

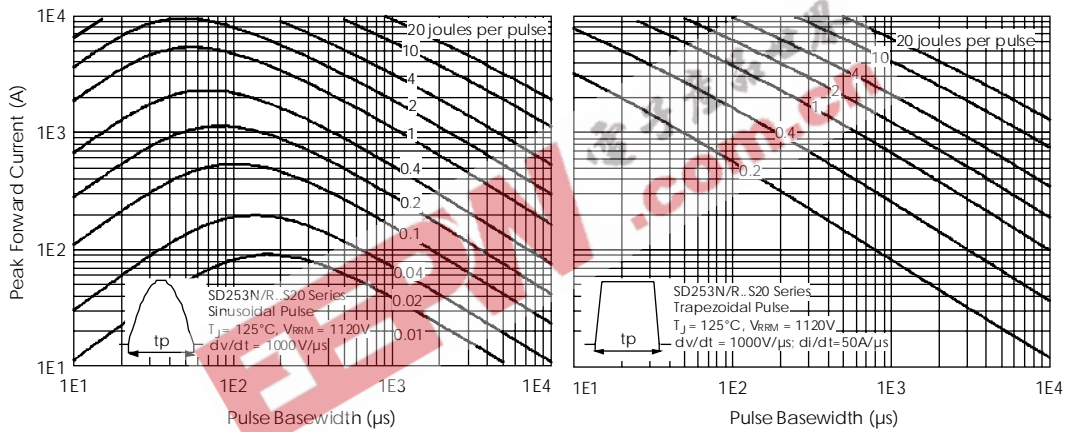

Fig. 16 - Maximum Total Energy Loss Per Pulse Characteristics