



## GENERAL DESCRIPTION

SM3502 is a Fan Controller CMOS IC that can be applied to a variety of consumer products. SM3502 has three wind modes; normal, rhythm and sleep-rhythm wind. Four kinds of timer setting and one swing head control or light control. Memory function is available; the Speed, Mode, Swing functions will operate as last state in memory type. If the last state is Sleep mode, press SPEED key enable fan controller while memory functions will be returned to the last state before Sleep Mode operation.

## FEATURES

- \* High performance CMOS technology.
- \* Four types of timer setting:  
Ladder adder (1/2-1-2-4hrs)  
Non-ladder adder (1-2-4-8hrs)
- \* One swing head control or light control.
- \* SPEED key can enable fan controller.
- \* 18 pin plastic DIP package.
- \* 455KHz oscillator.

## APPLICATIONS

- \* Electronic Fan
- \* Heater Fan
- \* Air-Cleaner
- \* Dehumidifier
- \* Humidifier
- \* Kitchen Exhaust
- \* Dish Dryer
- \* Wall Fan

## PIN ASSIGNMENTS

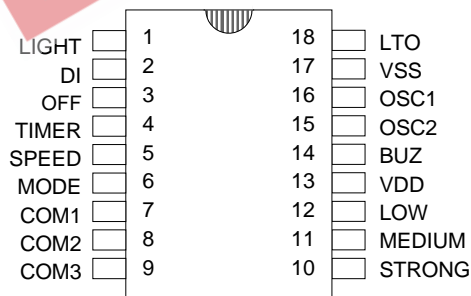

**SM3502-A 18PIN**

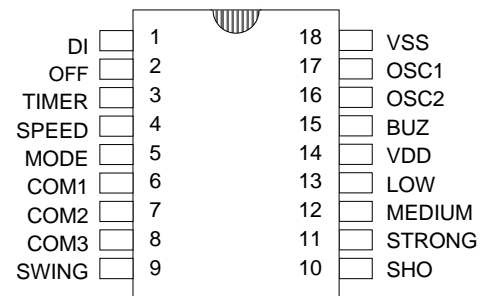

**SM3502-B 18PIN**



**PANEL DISPLAY**

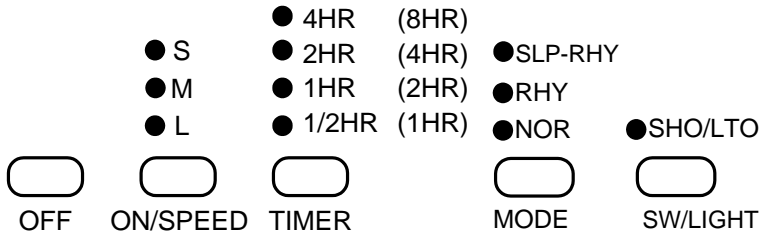

**SM3502**

**BLOCK DIAGRAM**

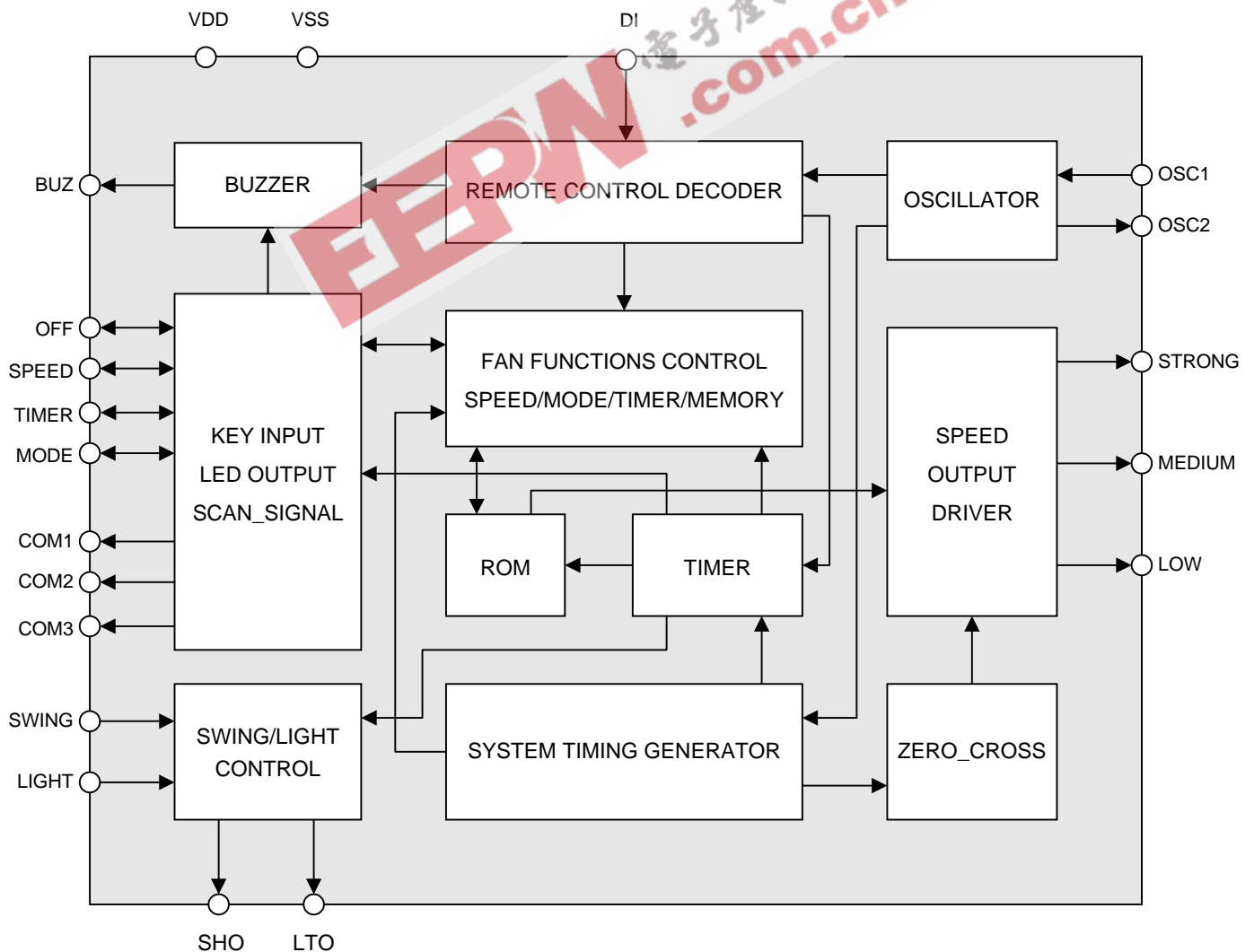



## PIN DESCRIPTIONS

No.	Pin Name	I/O	Function
1	LIGHT	I	Light control input
2	DI	I	Remote control input
3	OFF	I/O	Off function control input
4	TIMER	I/O	Timer setting input
5	SPEED	I/O	Wind grade selection input
6	MODE	I/O	Wind mode selection input
7	COM1	O	LED scanning common pin / Customer code
8	COM2	O	LED scanning common pin / Customer code
9	COM3	O	LED scanning common pin
10	SWING	I	Swing head control input / Customer code
11	SHO	O	Swing head / tuner pulse output
12	STRONG	O	Wind speed control output
13	MEDIUM	O	Wind speed control output
14	LOW	O	Wind speed control output
15	VDD	POWER	Positive power supply
16	BUZ	O	Trigger output to drive piezo
17	OSC2	O	Crystal output
18	OSC1	I	Crystal input
19	VSS	POWER	Negative power supply (Substrate)
20	LTO	O	Light control output



## FUNCTION DESCRIPTION

SM3502 has FIVE control signal operations :

- \* Start-up by SPEED key
  - a. function turn off (OFF key)
  - b. wind mode selection (MODE key)
  - c. start-up function and wind speed selection(SPEED key)
  - d. timer setting (TIMER key)
  - e. swing head or light control (SW or LIGHT Key)

Only SPEED key can enable the fan controller, except for the light control. Wind mode, timer and swing head inputs can not be accepted when fan is on. OFF key inputs.

When more than one key are pressed, controller will not accept the multi-key's control signal, if the panel keys are pressed more than six seconds, controller will generate a " BI-BI-BI-BI" warning sound. When fan is enabled by SPEED key, the initial state of fan controller is as follows:

- \* Memory function available  
If Fan controller is OFF on sleep mode, all memory functions will be returned to the LAST STATE BEFORE SLEEP MDOE operation.
  - a. Grade as last state but with starting medium wind for three seconds
  - b. The wind mode as last state except sleep mode
  - c. Swing function as last state
  - d. Timer setting off
  - e. Light is independent

### A. OFF KEY

When fan controller is on, press the OFF key, fan functions will be off except light output.

### B. SPEED KEY

When fan control is off, press SPEED key, fan is turned on, initial state is LOW wind; when memory function is available, the wind grade will operate as last state. Both conditions have three seconds starting wind. Press the SPEED key again, the wind will be changed as follows :

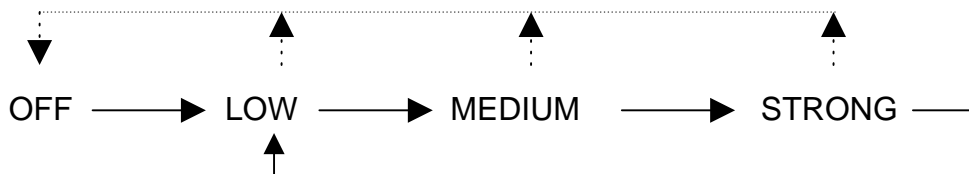

- > SPEED key used
- - - -> Pulse is put into OFF pin



### C. MODE KEY

SM3502 has three types of wind mode: normal, rhythm, sleep + rhythm. Memory function is available except on sleep mode.

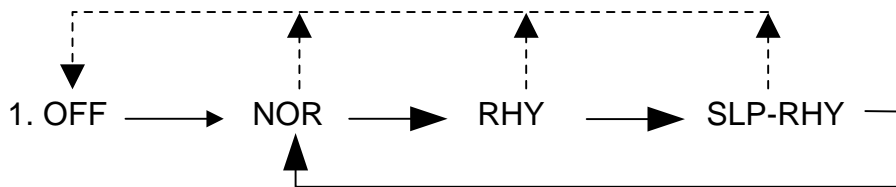

- ▶ : Press MODE key: normal setting
- - - -▶ : Pulse is put into OFF pin
- ▶ : SPEED key used

### D. LIGHTING CONTROL KEY

The LIGHT key is independent and the output is toggle function. When the LIGHT key is pressed on panel, operation is as follows :



- ▶ : Press LIGHT key

### E. SWING KEY:

The swing key will not activate when fan controller is off. Memory function is available, the swing output will operate as last state when press SPEED.

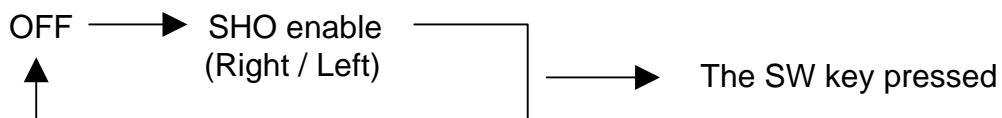



## F. TIMER KEY SETTING

SM3502 has many types of timer setting, mode "1" is ladder-adder and mode "2" is non-ladder adder for four steps. Timer key will not activate when fan controller is off. These types of timer may be chosen by bonding option.

MODE "1": Timer with accumulation

MODE "2": Timer with non-accumulation

LED display Timer Setting	Four-steps Type			
	A*1	A*2	A*3	A*4
0.5	●			
1.0		●		
1.5	●	●		
2.0			●	
2.5	●		●	
3.0		●	●	
3.5	●	●	●	
4.0				●
4.5	●			●
5.0		●		●
5.5	●	●		●
6.0			●	●
6.5	●		●	●
7.0		●	●	●
7.5	●	●	●	●

LED display Timer Setting.	Four-steps Type			
	A	B	C	D
1	●			
2		●		
4			●	
8				●

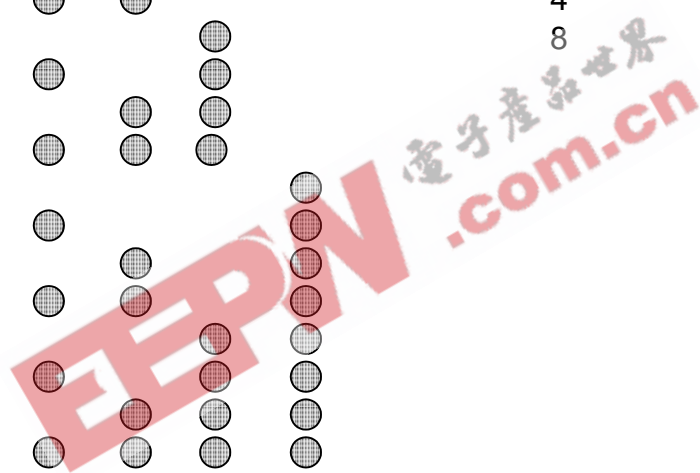

## G. MEMORY FUNCTION

When memory function is available, wind speed, mode and swing functions will operate as last state; if last state is sleep mode, press SPEED key enable fan controller while memory functions(Speed/Mode/Swing) will be returned to the last state before sleep mode operation.

## H. STARTING WIND

Fan controller starts with three seconds starting wind (Medium wind).



## I. BUZZER

Any key pressed on panel which will generate a 4KHz 50% duty cycle pulse train on buzzer output pin.

### a. When FAN is from stop mode to start mode (press SPEED key)

Buzzer output will generate a "BI-BI" sound.

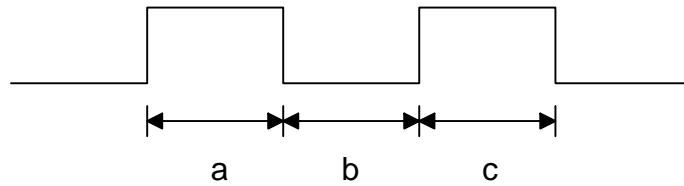

### b. When FAN is from start mode to stop mode (press OFF key)

Buzzer output will generate a long "BI" sound.



### c. When FAN is operating (press any key other than OFF key)

Buzzer output will generate a "BI" sound.

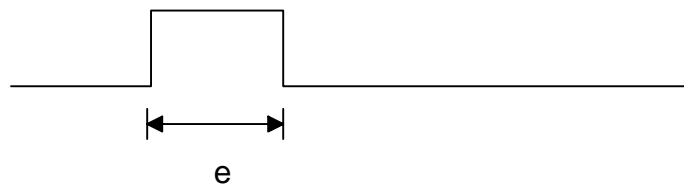

When  $a = c = e = 62\text{ms}$   
 $b = 124\text{ms}$   
 $d = 250\text{ms}$



### J. RHYTHM WIND FUNCTION

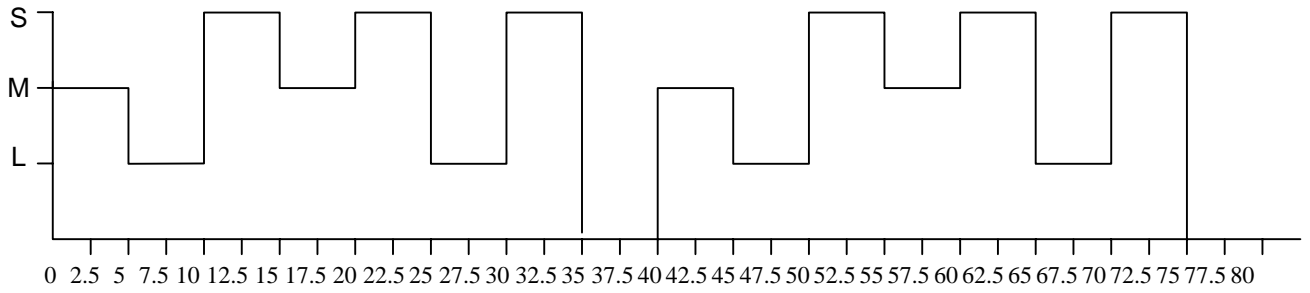

STRONG RHYTHM WIND PATTERN

(SEC)

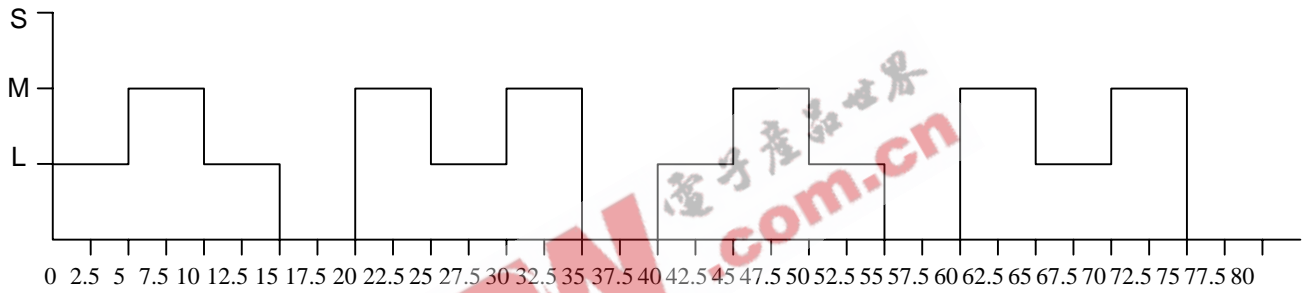

MEDIUM RHYTHM WIND PATTERN

(SEC)

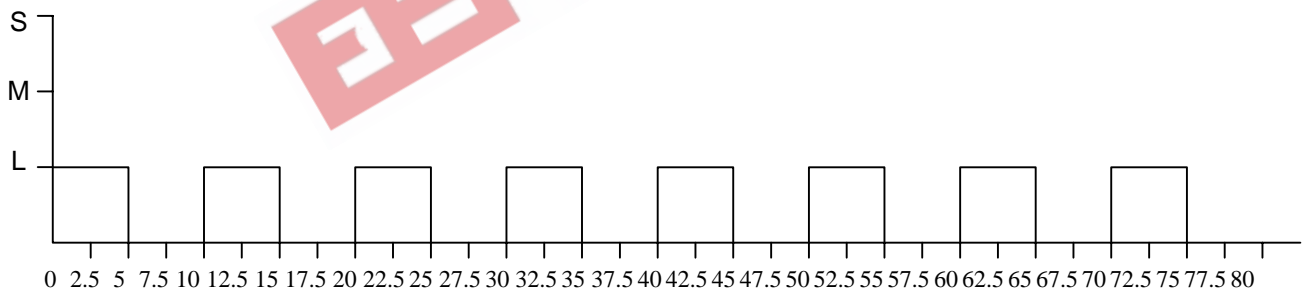

LOW RHYTHM WIND PATTERN

(SEC)

### K. SLEEP FUNCTION

In sleep mode, wind grade is changed by timing automatically and the wind grade goes down automatically one step every 0.5hrs, until low wind level is reached..

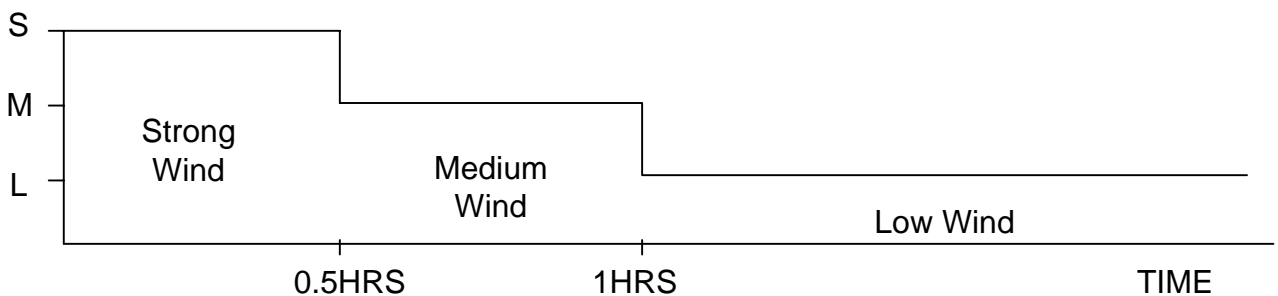





**TIMING  
CONTROL**

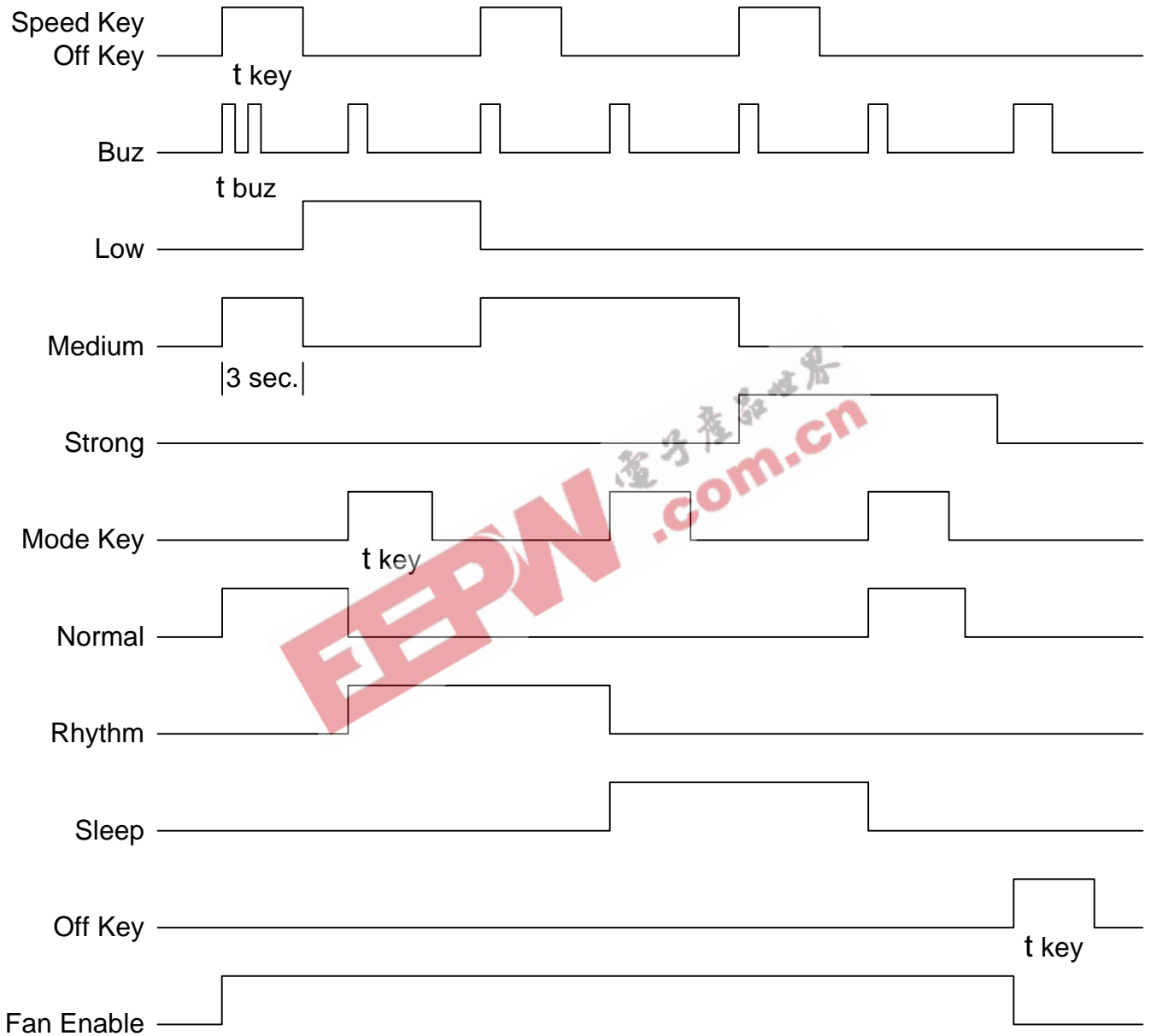

\* NOTE:  $t_{buz}$  see page 12 and  $t_{key}$  see page 6

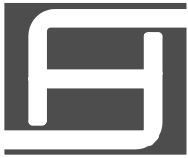

## DC ELECTRICAL CHARACTERISTICS

Parameter	Symbol	Test Conditions	Limits			Unit
			Min.	Typ.	Max.	
Supply Voltage	VDD		3	5	6	V
Stand-by Current	ISB	OSC stop all output pins open all input fixed to VDD			500	uA
Input High Level	VIH		3.5			V
Input Low Level	VIL				1.5	V
Sink Current (OFF,MODE,SPEED TIMER,SLEEP)	IOL	VOL=+0.7V		10		mA
Source Current (OFF,MODE,SPEED TIMER,SLEEP)	IOH	VOH=+4.3V		10		mA
Triac Sink Current (S,M,L,SW1, SW2,LIGHT)	IOL	VOL=+0.7V		10		mA
Triac Source Current (S,M,L,SW1, SW2,LIGHT)	IOH	VOH=+4.3V		5		mA
Sink Current (COM1~COM3)	IOL	VOL=+0.7V		40		mA
Source Current (COM1~COM3)	IOH	VOH=+4.3V		10		mA
Sink Current (BUZ)	IOL	VOL=+0.7V		4		mA
Source Current (BUZ)	IOH	VOH=+4.3V		5		mA
Pull-high Resister (Input pin)	RPH			200		K OHM

\*NOTE: All test conditions are on VDD = 5V / VSS = GND

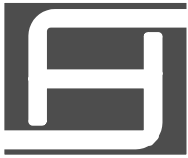

### ABSOLUTE MAXIMUM RATINGS

Parameter	Symbol	Test conditions	Ratings	Unit
Supply Voltage	VDD-VSS		-0.3~6	V
Input Voltage	Vi-VSS		VSS-0.3~VDD+0.3	V
Output Voltage	Vo-VSS		VSS-0.3~VDD+0.3	V
Maximum Power Consumption	Pa	VDD-VSS=5V	500	mW
Operating Temperature	Topr		-10~70	°C
Storage Temperature	Tstg		-40~125	°C

### SM3502 POWER SUPPLY APPLICATION CIRCUIT

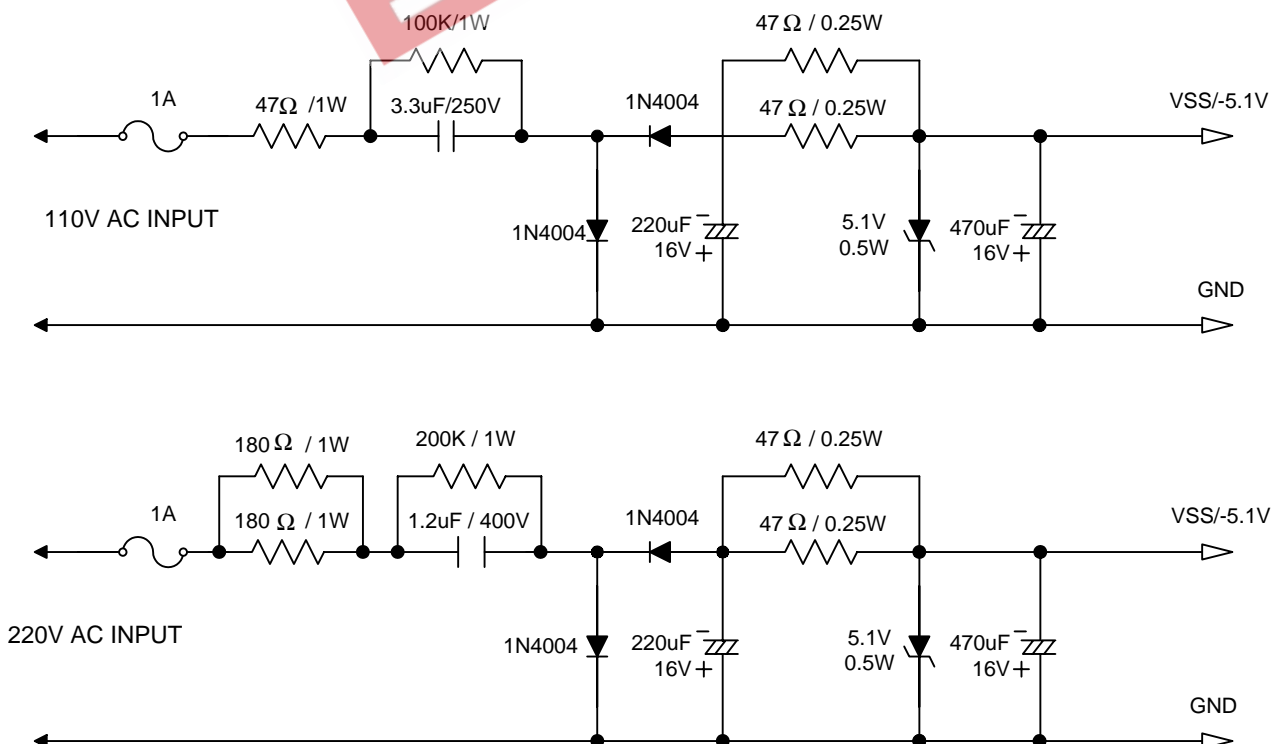



**ORDERING INFORMATION**

