

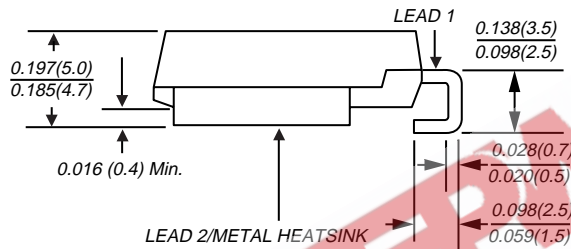

Surface Mount Automotive Transient Voltage Suppressors

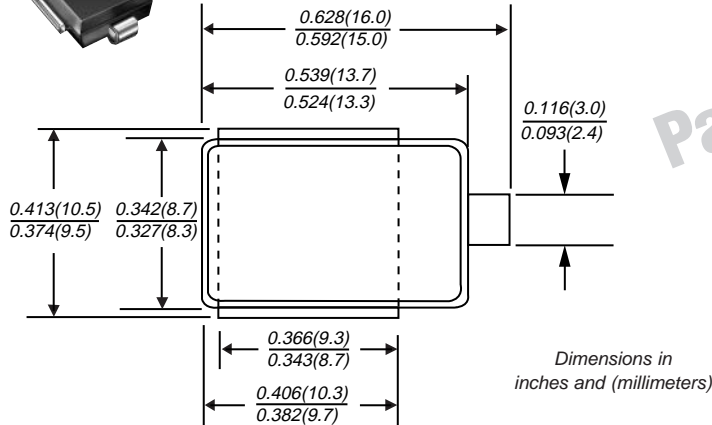

DO-218AB



Stand-off Voltage 10 to 36V
Peak Pulse Power 4600W (10/1000μs)
3600W (10/10,000μs)

Mounting Pad Layout

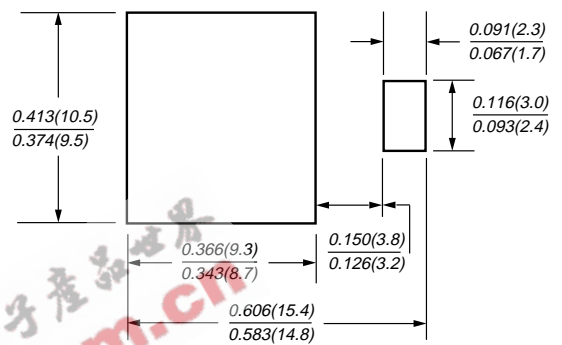

*Patent #'s:
4,980,315
5,166,769
5,278,095

Features

- Ideally suited for load dump protection
- Plastic package has Underwriters Laboratory Flammability Classification 94V-0
- High temperature stability due to unique oxide passivation and patented PAR[®] construction
- Integrally molded heatsink provides a very low thermal resistance for maximum heat dissipation
- Low leakage current at T_J = 175°C
- High temperature soldering guaranteed: 260°C for 10 seconds at terminals
- Meets ISO7637-2 surge spec.
- Low forward voltage drop

Mechanical Data

- Case:** Molded plastic body, surface mount with heatsink integrally mounted in the encapsulation
- Terminals:** Plated, solderable per MIL-STD-750, Method 2026
- Polarity:** Heatsink is anode
- Mounting Position:** Any
- Weight:** 0.091 oz., 2.58 g
- Packaging codes/options:**
2D/750 per 13" Reel (16mm Tape), anode towards sprocket hole, 4.5K/box
2E/750 per 13" Reel (16mm Tape), cathode towards sprocket hole, 4.5K/box

Maximum Ratings and Thermal Characteristics (T_C = 25°C unless otherwise noted)

Parameter	Symbol	Value	Unit
Peak pulse power dissipation with 10/1000μs waveform 10/10,000μs waveform	PPPM	4600 3600	W
Steady state power dissipation	P _D	6.0	W
Peak pulse current with a 10/1000μs waveform (NOTE 1)	I _{PPM}	See Table 1	A
Peak forward surge current, 8.3ms single half sine-wave	I _{FSM}	600	A
Typical thermal resistance junction to case	R _{θJC}	0.95	°C/W
Operating junction and storage temperature range	T _J , T _{STG}	-55 to +175	°C

Notes: (1) Non-repetitive current pulse derated above T_A=25°C

SM6S Series

Vishay Semiconductors
formerly General Semiconductor



Electrical Characteristics (T_c = 25°C unless otherwise noted)

Device Type	Breakdown Voltage V _(BR) (V)		Test Current I _T (mA)	Stand-off Voltage V _{WM} (V)	Maximum Reverse Leakage at V _{WM} I _D (μA)	Maximum Reverse Leakage at V _{WM} T _c =175°C I _D (μA)	Max. Peak Pulse Current at 10/1000μs Waveform (A)	Maximum Clamping Voltage at I _{PPM} V _c (V)
	Min.	Max.						
SM6S10	11.1	13.6	5.0	10.0	15	250	245	18.8
SM6S10A	11.1	12.3	5.0	10.0	15	250	271	17.0
SM6S11	12.2	14.9	5.0	11.0	10	150	229	20.1
SM6S11A	12.2	13.5	5.0	11.0	10	150	253	18.2
SM6S12	13.3	16.3	5.0	12.0	10	150	209	22.0
SM6S12A	13.3	14.7	5.0	12.0	10	150	231	19.9
SM6S13	14.4	17.6	5.0	13.0	10	150	193	23.8
SM6S13A	14.4	15.9	5.0	13.0	10	150	214	21.5
SM6S14	15.6	19.1	5.0	14.0	10	150	178	25.8
SM6S14A	15.6	17.2	5.0	14.0	10	150	198	23.2
SM6S15	16.7	20.4	5.0	15.0	10	150	171	26.9
SM6S15A	16.7	18.5	5.0	15.0	10	150	189	24.4
SM6S16	17.8	21.8	5.0	16.0	10	150	160	28.8
SM6S16A	17.8	19.7	5.0	16.0	10	150	177	26.0
SM6S17	18.9	23.1	5.0	17.0	10	150	151	30.5
SM6S17A	18.9	20.9	5.0	17.0	10	150	167	27.6
SM6S18	20.0	24.4	5.0	18.0	10	150	143	32.2
SM6S18A	20.0	22.1	5.0	18.0	10	150	158	29.2
SM6S20	22.2	27.1	5.0	20.0	10	150	128	35.8
SM6S20A	22.2	24.5	5.0	20.0	10	150	142	32.4
SM6S22	24.4	29.8	5.0	22.0	10	150	117	39.4
SM6S22A	24.4	26.9	5.0	22.0	10	150	130	35.5
SM6S24	26.7	32.6	5.0	24.0	10	150	107	43.0
SM6S24A	26.7	29.5	5.0	24.0	10	150	118	38.9
SM6S26	28.9	35.3	5.0	26.0	10	150	99	46.6
SM6S26A	28.9	31.9	5.0	26.0	10	150	109	42.1
SM6S28	31.1	38.0	5.0	28.0	10	150	92	50.1
SM6S28A	31.1	34.4	5.0	28.0	10	150	101	45.4
SM6S30	33.3	40.7	5.0	30.0	10	150	86	53.5
SM6S30A	33.3	36.8	5.0	30.0	10	150	95	48.4
SM6S33	36.7	44.9	5.0	33.0	10	150	78	59.0
SM6S33A	36.7	40.6	5.0	33.0	10	150	86	53.3
SM6S36	40.0	48.9	5.0	36.0	10	150	72	64.3
SM6S36A	40.0	44.2	5.0	36.0	10	150	79	58.1

Note: For all types maximum V_F = 1.9V at I_F = 100A measured on 8.3ms single half sine-wave or equivalent square wave, duty cycle = 4 pulses per minute maximum



Ratings and Characteristic Curves ($T_A = 25^\circ\text{C}$ unless otherwise noted)

Power Derating Curve

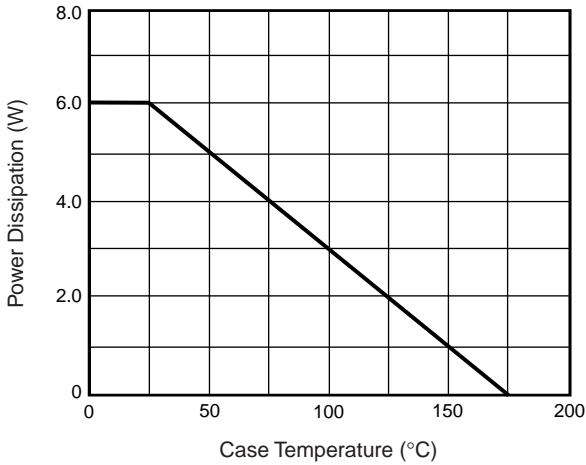

Load Dump Power Characteristics (10ms Exponential Waveform)

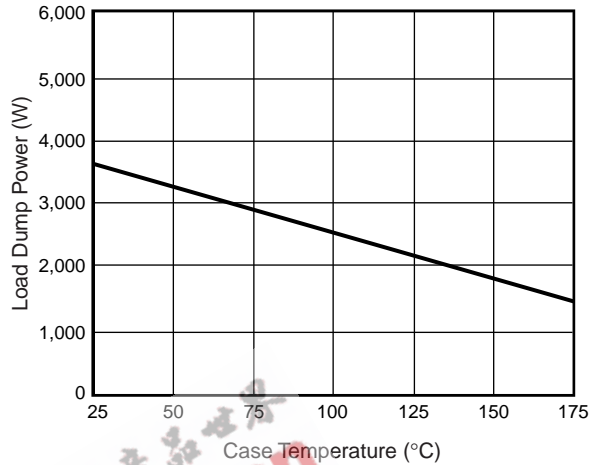

Pulse Waveform

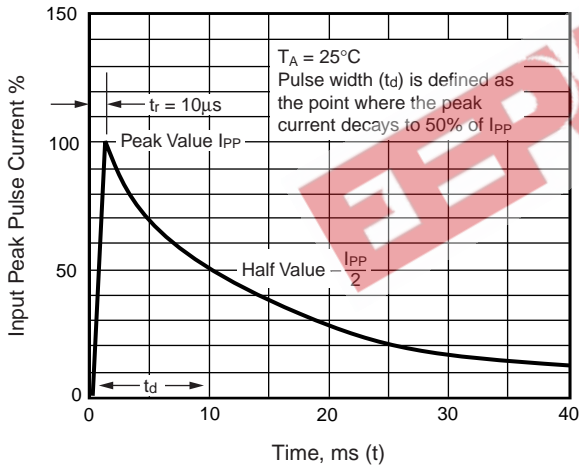

Reverse Power Capability

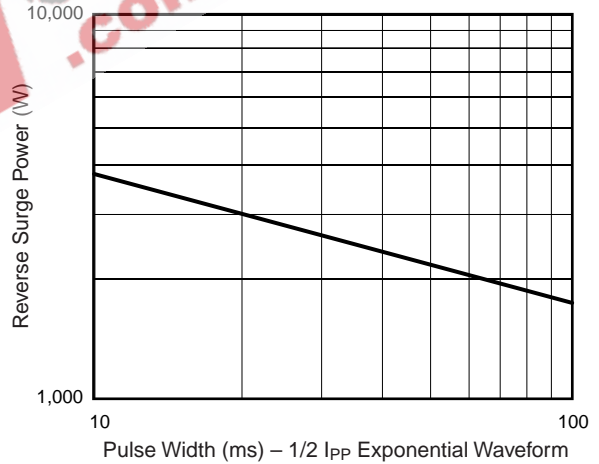

Typical Transient Thermal Impedance

