

Silicon Switching Diode Array

SMBD 2835
SMBD 2836

- For high-speed switching applications
- Common anode

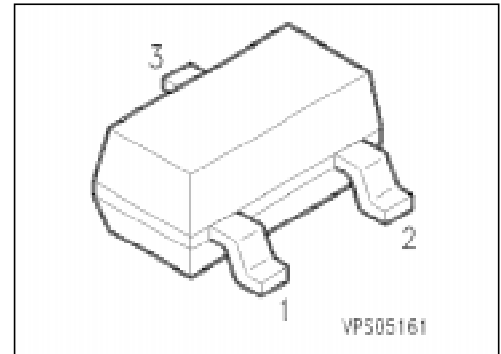
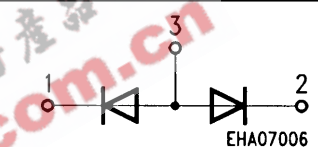

Type	Marking	Ordering Code (tape and reel)	Pin Configuration	Package ¹⁾
SMBD 2835 SMBD 2836	sA3 sA2	Q68000-A8547 Q68000-A8436		SOT-23

Maximum Ratings

Parameter	Symbol	Values		Unit
		SMBD 2835	SMBD 2836	
Reverse voltage	V_R	30	50	V
Peak reverse voltage	V_{RM}	35	75	
Forward current	I_F	200		mA
Surge forward current, $t = 1 \mu s$	I_{FS}	4.5		A
Total power dissipation, $T_s = 31 \text{ }^\circ\text{C}$	P_{tot}	330		mW
Junction temperature	T_j	150		$^\circ\text{C}$
Storage temperature range	T_{stg}	- 65 ... + 150		

Thermal Resistance

Junction - ambient ²⁾	$R_{th JA}$	≤ 500	K/W
Junction - soldering point	$R_{th JS}$	≤ 360	

¹⁾ For detailed information see chapter Package Outlines.

²⁾ Package mounted on epoxy pcb 40 mm × 40 mm × 1.5 mm/6 cm² Cu.

Electrical Characteristics

at $T_A = 25\text{ }^\circ\text{C}$, unless otherwise specified.

Parameter	Symbol	Values			Unit
		min.	typ.	max.	

DC characteristics

Breakdown voltage $I_{(BR)} = 100\text{ }\mu\text{A}$	SMBD 2835 SMBD 2836	$V_{(BR)}$	35 75	— —	— —	V
Forward voltage $I_F = 10\text{ mA}$ $I_F = 50\text{ mA}$ $I_F = 100\text{ mA}$		V_F	— — —	— — —	855 1000 1200	mV
Reverse current $V_R = 30\text{ V}$ $V_R = 50\text{ V}$	SMBD 2835 SMBD 2836	I_R	— —	— —	100 100	nA

AC characteristics

Diode capacitance $V_R = 0, f = 1\text{ MHz}$		C_D	—	—	4	pF
Reverse recovery time $I_F = 10\text{ mA}, I_R = 10\text{ mA}, R_L = 100\text{ }\Omega$ measured at $I_R = 1\text{ mA}$		t_{rr}	—	—	6	ns

Test circuit for reverse recovery time

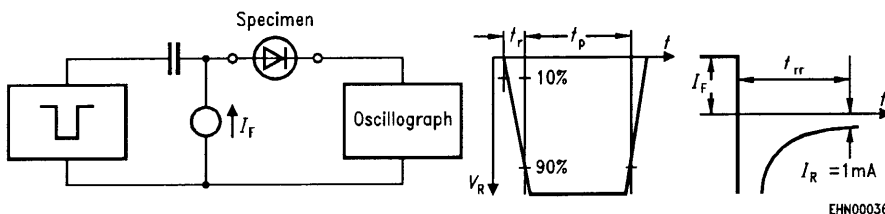

Pulse generator: $t_p = 100\text{ ns}, D = 0.05$
 $t_r = 0.6\text{ ns}, R_j = 50\text{ }\Omega$

Oscilloscope: $R = 50\text{ }\Omega$
 $t_r = 0.35\text{ ns}$
 $C \leq 1\text{ pF}$

Forward current $I_F = f(T_A^*; T_S)$

* Package mounted on epoxy

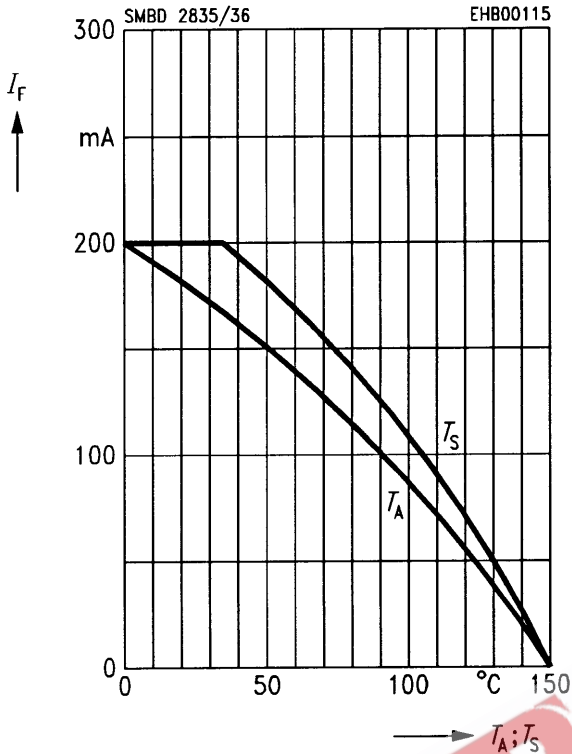

Reverse current $I_R = f(T_A)$

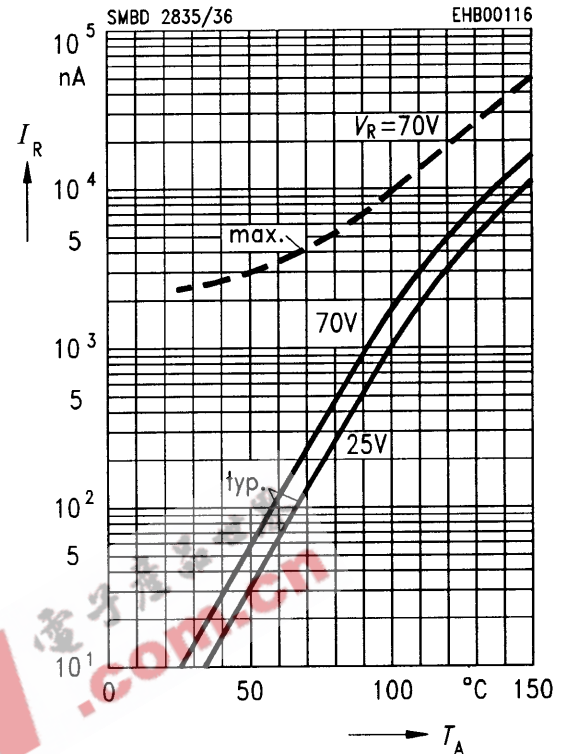

Forward current $I_F = f(V_F)$

$T_A = 25\text{ }^\circ\text{C}$

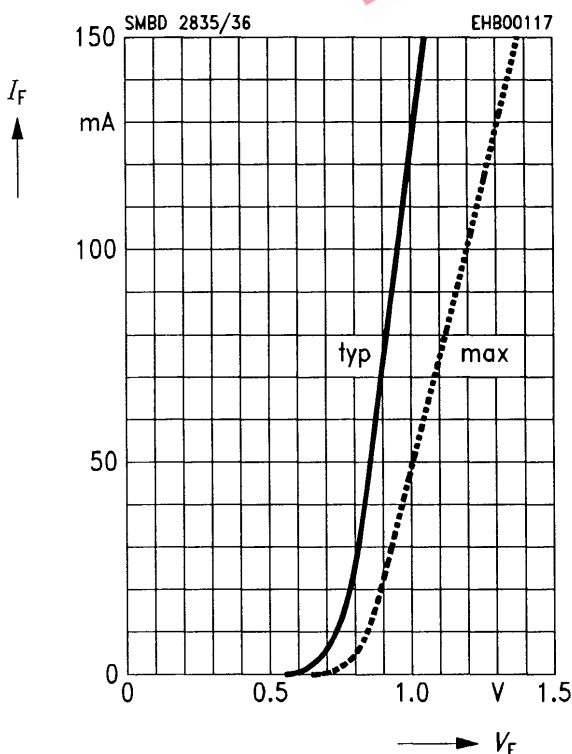

Peak forward current $I_{FM} = f(t)$

$T_A = 25\text{ }^\circ\text{C}$

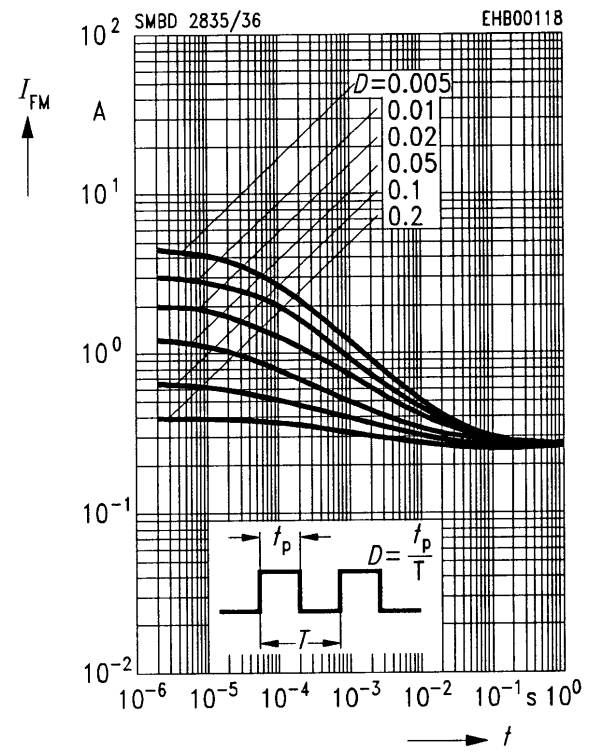

Forward voltage $V_F = f(T_A)$

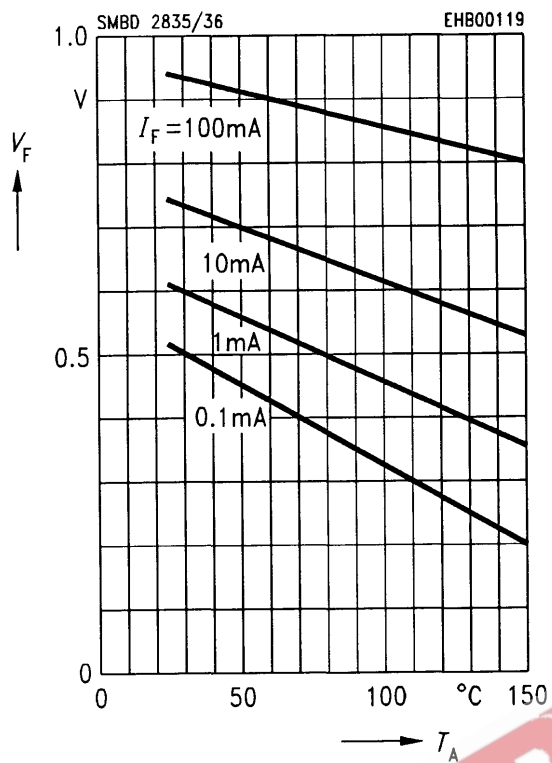

EEPW 电子产品世界 .com.cn