

DATA SHEET

SMP1307 Series: Very Low Distortion Attenuator Plastic Packaged PIN Diodes

Features

- Low distortion design
- Frequency range from HF to > 2 GHz
- Designed for CATV AGC applications
- Designed for high volume wireless applications

Description

The SMP1307 series of plastic packaged, surface mountable, low capacitance (0.3 pF) silicon PIN diodes are designed for use in attenuator applications from 5 MHz to beyond 2 GHz. The thick 175 μm I region of these PIN diodes makes them very attractive for use in very low distortion PI and TEE attenuators commonly used in TV distribution applications. The 1.5 μs typical carrier lifetime of these diodes results in resistance of 100 Ω maximum at 1 mA and 10 Ω maximum at 10 mA. Available in a selection of plastic packages, as a single diode in the small footprint SOD-323, and in a variety of configurations in the SOT-23. Also available in a SOT-5 (SMP1307-027) package as a four diode array designed for insertion in the commonly used 4 diode PI attenuator circuit.

NEW Skyworks offers lead (Pb)-free “environmentally friendly” packaging that is RoHS compliant (European Parliament for the Restriction of Hazardous Substances).







Absolute Maximum Ratings

Characteristic	Value
Reverse voltage (V_R)	200 V
Power dissipation @ 25 °C lead temperature (P_D)	250 mW
Storage temperature (T_{ST})	-65 °C to +150 °C
Operating temperature (T_{OP})	-65 °C to +150 °C
ESD human body model	Class 1C

Performance is guaranteed only under the conditions listed in the specifications table and is not guaranteed under the full range(s) described by the Absolute Maximum specifications. Exceeding any of the absolute maximum/minimum specifications may result in permanent damage to the device and will void the warranty.

CAUTION: Although this device is designed to be as robust as possible, Electrostatic Discharge (ESD) can damage this device. This device must be protected at all times from ESD. Static charges may easily produce potentials of several kilovolts on the human body or equipment, which can discharge without detection. Industry-standard ESD precautions must be employed at all times.

				
Single	Common Cathode	Series Pair	Single	PI
SOT-23	SOT-23	SOT-23	SOD-323	SOT-5
SMP1307-001	SMP1307-004	SMP1307-005	SMP1307-011	SMP1307-027
Marking: PJ1	Marking: PJ3	Marking: PJ2	Marking: PJ	Marking: PJM
SMP1307-001LF	SMP1307-004LF	SMP1307-005LF	SMP1307-011LF	
Marking: RJ1	Marking: RJ3	Marking: RJ2	Marking: RJ	
$L_S = 1.5 \text{ nH}$	$L_S = 1.5 \text{ nH}$	$L_S = 1.5 \text{ nH}$	$L_S = 1.5 \text{ nH}$	

LF denotes lead (Pb)-free packaging option as an alternative to our standard tin/lead (Sn/Pb) packaging.

Electrical Specifications at 25 °C

Parameter	Condition	Typ.	Max.	Unit
Reverse current (I_R)	$V_R = 200\text{ V}$		10	μA
Capacitance (C_T) ⁽¹⁾	$F = 1\text{ MHz}, V = 30\text{ V}$		0.30	pF
Resistance (R_S)	$F = 100\text{ MHz}, I = 1\text{ mA}$	75	100	Ω
Resistance (R_S)	$F = 100\text{ MHz}, I = 10\text{ mA}$		15	Ω
Resistance (R_S)	$F = 100\text{ MHz}, I = 100\text{ mA}$		3.0	Ω
Forward voltage (V_F)	$I_F = 10\text{ mA}$	0.85		V
Carrier lifetime (TI)	$I_F = 10\text{ mA}$	1.5		μs
I region width		175		μm

1. The SMP1307-027 maximum capacitance is 0.45 pF.

Typical Performance Data

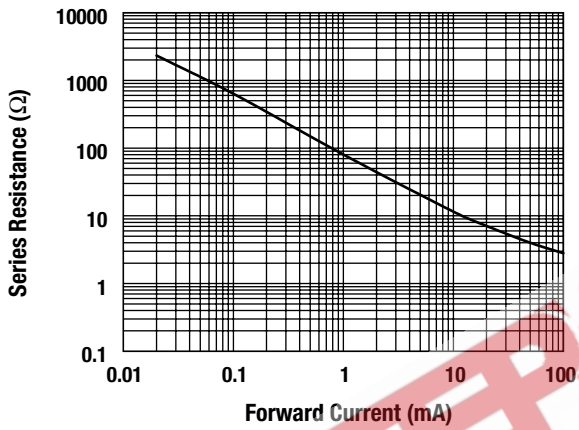

Series Resistance vs. Current @ 100 MHz

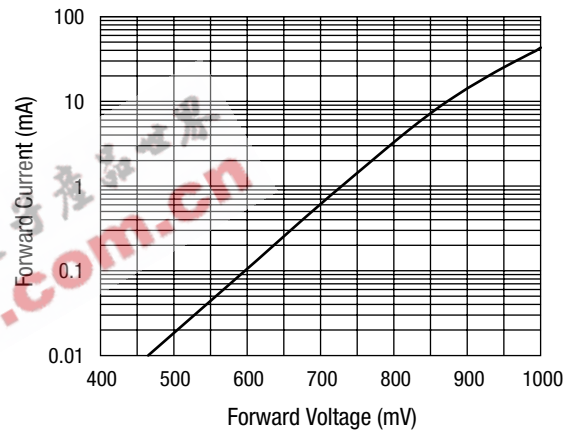

DC Characteristic

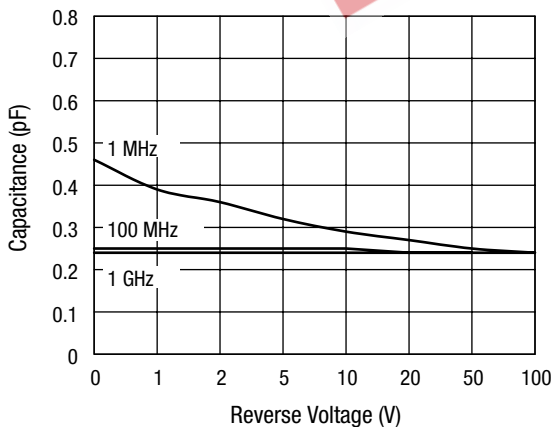

Capacitance vs. Reverse Voltage

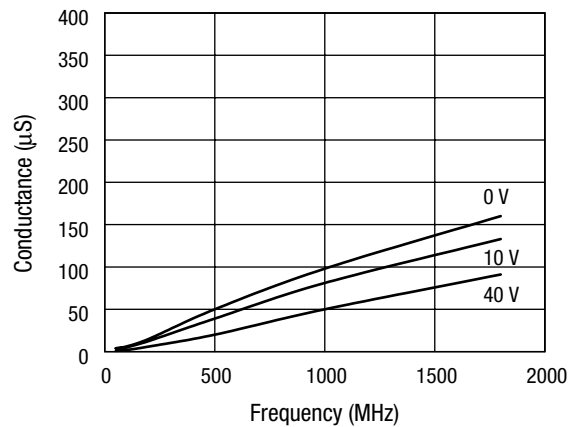

Conductance vs. Frequency and Reverse Voltage

Typical Resistance vs. Temperature @ 100 MHz

I_F (mA)	-55 °C (Ω)	-15 °C (Ω)	+25 °C (Ω)	+65 °C (Ω)	+100 °C (Ω)
0.02	2386.0	2360.0	2546.0	2520.0	2440.0
0.10	572.0	598.0	632.0	633.0	639.0
0.30	203.0	219.0	236.0	239.0	242.0
1.00	66.1	71.2	79.3	83.6	85.4
10.00	9.1	10.0	10.9	12.2	12.9
20.00	5.6	6.0	6.6	7.4	7.8
100.00	2.2	2.4	2.6	3.0	3.2

SMP1307-027 4 Diode PI Attenuator

The SMP1307-027 employs 4 PIN diode junctions in a 5-lead SOT package. It is configured for ease of insertion in the PI attenuator circuit commonly used for broadband TV distribution systems, covering a frequency range from 5 MHz to beyond 1 GHz.

A broadband attenuator was designed using the SMP1307-027 showing good performance to 2 GHz. The attenuator was evaluated with a 50 Ω source and load impedance. The following figure shows the circuit diagram and measured performance.

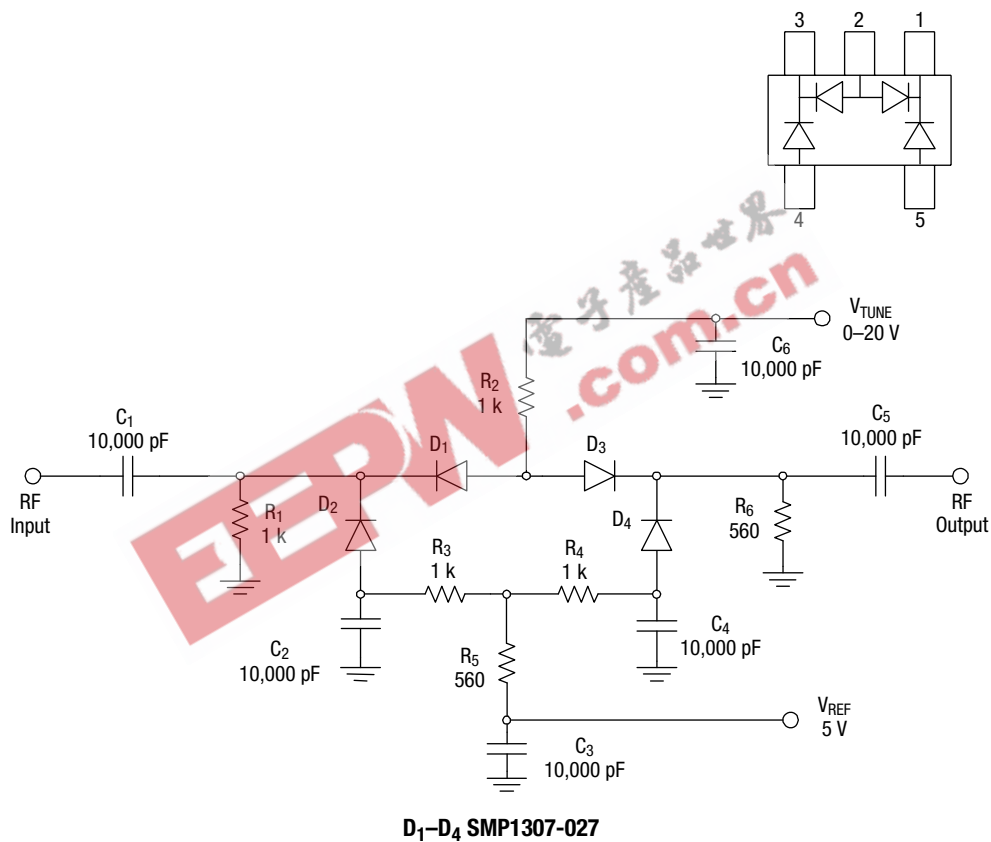

A 4 diode PI attenuator utilizing individual SMP1307-011 PIN diodes is described in the "A Wideband General Purpose PIN Diode Attenuator" Application Note.

Recommended Solder Reflow Profiles

Profile Feature	SnPb Eutectic Assembly	Lead (Pb)-Free Assembly 100% Sn
Average ramp-up rate (T_L to T_P)	3 °C/second max.	3 °C/second max.
Preheat Temperature min. (T_{SMIN}) Temperature max. (T_{SMAX}) Time (min. to max.) (t_s)	100 °C 150 °C 60–120 seconds	150 °C 200 °C 60–80 seconds
T_{SMAX} to T_L Ramp-up rate	—	3 °C/second max.
Time maintained above: Temperature (T_L) Time (t_L)	183 °C 60–150 seconds	217 °C 60–150 seconds
Peak temperature (T_P)	240 +0/-5 °C	250 +0/-5 °C
Time within 5 °C of actual peak temperature (t_p)	10–30 seconds	20–40 seconds
Ramp-down rate	6 °C/second max.	6 °C/second max.
Time 25 °C to peak temperature	6 minutes max.	8 minutes max.

All temperatures refer to the topside of the package, measured on the package body surface.
Reference JEDEC J-STD-020B.

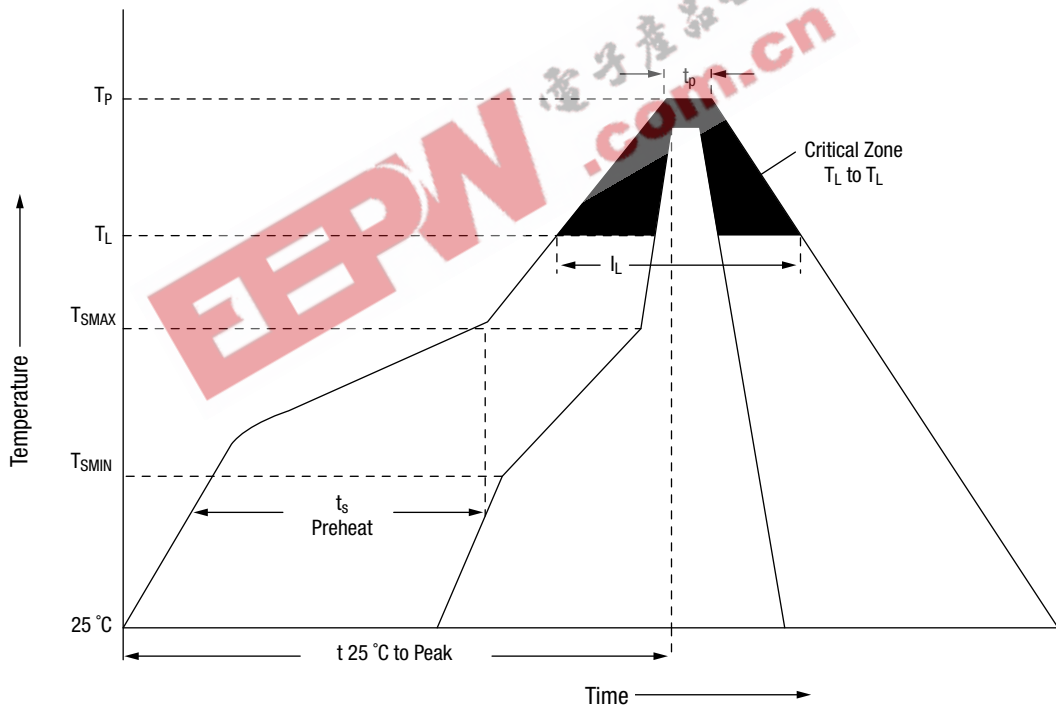

Reference JEDEC J-STD-020

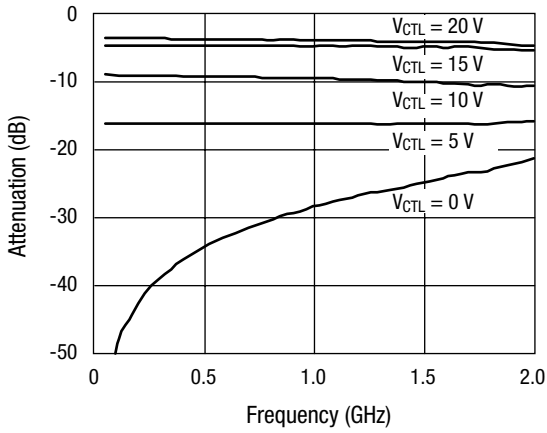

SMP1307-027 Attenuation vs. Frequency

SOT-5

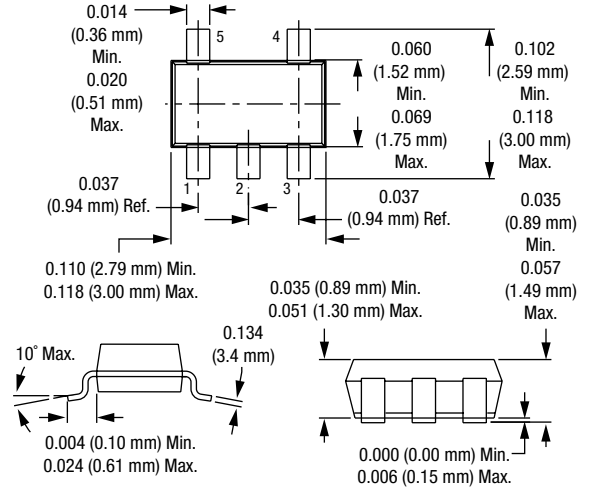

SOT-23

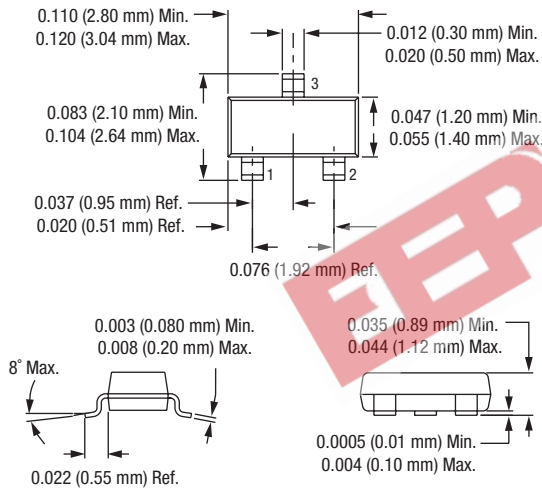

SOD-323

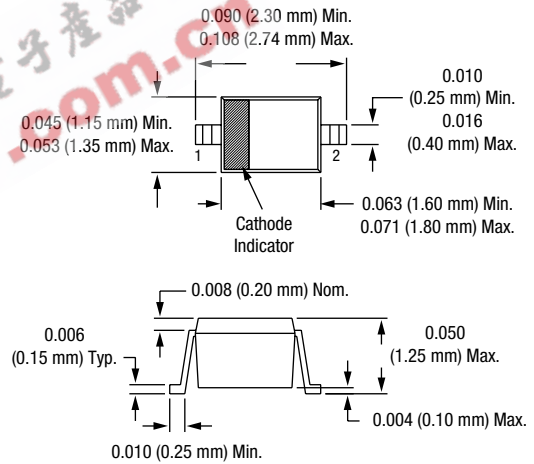



Copyright © 2002, 2003, 2004, Skyworks Solutions, Inc. All Rights Reserved.

Information in this document is provided in connection with Skyworks Solutions, Inc. ("Skyworks") products. These materials are provided by Skyworks as a service to its customers and may be used for informational purposes only by the customer. Skyworks assumes no responsibility for errors or omissions in these materials. Skyworks may make changes to its documentation, products, specifications and product descriptions at any time, without notice. Skyworks makes no commitment to update the information and shall have no responsibility whatsoever for conflicts, incompatibilities, or other difficulties arising from future changes to its documentation, products, specifications and product descriptions.

No license, express or implied, by estoppel or otherwise, to any intellectual property rights is granted by or under this document. Except as may be provided in Skyworks Terms and Conditions of Sale for such products, Skyworks assumes no liability whatsoever in association with its documentation, products, specifications and product descriptions.

THESE MATERIALS ARE PROVIDED "AS IS" WITHOUT WARRANTY OF ANY KIND, EITHER EXPRESS OR IMPLIED OR OTHERWISE, RELATING TO SALE AND/OR USE OF SKYWORKS PRODUCTS INCLUDING WARRANTIES RELATING TO FITNESS FOR A PARTICULAR PURPOSE, MERCHANTABILITY, PERFORMANCE, QUALITY OR NON-INFRINGEMENT OF ANY PATENT, COPYRIGHT OR OTHER INTELLECTUAL PROPERTY RIGHT. SKYWORKS FURTHER DOES NOT WARRANT THE ACCURACY OR COMPLETENESS OF THE INFORMATION, TEXT, GRAPHICS OR OTHER ITEMS CONTAINED WITHIN THESE MATERIALS. SKYWORKS SHALL NOT BE LIABLE FOR ANY DAMAGES, INCLUDING SPECIAL, INDIRECT, INCIDENTAL, OR CONSEQUENTIAL DAMAGES, INCLUDING WITHOUT LIMITATION, LOST REVENUES OR LOST PROFITS THAT MAY RESULT FROM THE USE OF THESE MATERIALS WHETHER OR NOT THE RECIPIENT OF MATERIALS HAS BEEN ADVISED OF THE POSSIBILITY OF SUCH DAMAGE.

Skyworks products are not intended for use in medical, lifesaving or life-sustaining applications. Skyworks customers using or selling Skyworks products for use in such applications do so at their own risk and agree to fully indemnify Skyworks for any damages resulting from such improper use or sale.

The following are trademarks of Skyworks Solutions, Inc.: Skyworks™, the Skyworks logo, and Breakthrough Simplicity™. Product names or services listed in this publication are for identification purposes only, and may be trademarks of Skyworks or other third parties. Third-party brands and names are the property of their respective owners. Additional information, posted at www.skyworksinc.com, is incorporated by reference.