

PNP Silicon Transistors for High Voltages

SMBTA 92
SMBTA 93

- High breakdown voltage
- Low collector-emitter saturation voltage
- Complementary types: SMBTA 42, SMBTA 43 (NPN)

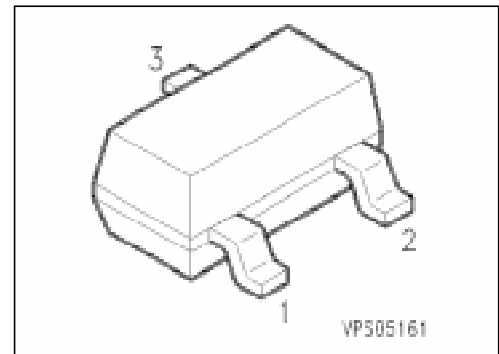

Type	Marking	Ordering Code (tape and reel)	Pin Configuration			Package ¹⁾
			1	2	3	
SMBTA 92	s2D	Q68000-A6479	B	E	C	SOT-23
SMBTA 93	s2E	Q68000-A6483				

Maximum Ratings

Parameter	Symbol	Values		Unit
		SMBTA 92	SMBTA 93	
Collector-emitter voltage	V_{CE0}	300	200	V
Collector-base voltage	V_{CB0}	300	200	
Emitter-base voltage	V_{EB0}	5		
Collector current	I_C	500		mA
Base current	I_B	100		
Total power dissipation, $T_s = 74\text{ °C}$	P_{tot}	360		mW
Junction temperature	T_j	150		°C
Storage temperature range	T_{stg}	- 65 ... + 150		

Thermal Resistance

Junction - ambient ²⁾	$R_{th\ JA}$	≤ 280	K/W
Junction - soldering point	$R_{th\ JS}$	≤ 210	

¹⁾ For detailed information see chapter Package Outlines.

²⁾ Package mounted on epoxy pcb 40 mm × 40 mm × 1.5 mm/6 cm² Cu.

Electrical Characteristics

at $T_A = 25\text{ }^\circ\text{C}$, unless otherwise specified.

Parameter	Symbol	Values			Unit
		min.	typ.	max.	

DC characteristics

Collector-emitter breakdown voltage $I_C = 1\text{ mA}$	SMBTA 92 SMBTA 93	$V_{(BR)CE0}$	300 200	— —	— —	V
Collector-base breakdown voltage $I_C = 100\text{ }\mu\text{A}$	SMBTA 92 SMBTA 93	$V_{(BR)CB0}$	300 200	— —	— —	
Emitter-base breakdown voltage $I_E = 100\text{ }\mu\text{A}$		$V_{(BR)EB0}$	5	—	—	
Collector-base cutoff current $V_{CB} = 200\text{ V}$ $V_{CB} = 160\text{ V}$ $V_{CB} = 200\text{ V}, T_A = 150\text{ }^\circ\text{C}$ $V_{CB} = 160\text{ V}, T_A = 150\text{ }^\circ\text{C}$	SMBTA 92 SMBTA 93 SMBTA 92 SMBTA 93	I_{CB0}	— — — —	— — — —	250 250 20 20	nA nA μA μA
Emitter-base cutoff current $V_{EB} = 3\text{ V}$		I_{EB0}	—	—	100	nA
DC current gain $I_C = 1\text{ mA}, V_{CE} = 10\text{ V}$ $I_C = 10\text{ mA}, V_{CE} = 10\text{ V}^{1)}$ $I_C = 30\text{ mA}, V_{CE} = 10\text{ V}^{1)}$	SMBTA 92 SMBTA 93	h_{FE}	25 40 25 25	— — — —	— — — —	—
Collector-emitter saturation voltage ¹⁾ $I_C = 20\text{ mA}, I_B = 2\text{ mA}$	SMBTA 92 SMBTA 93	V_{CEsat}	— —	— —	0.5 0.4	V
Base-emitter saturation voltage ¹⁾ $I_C = 20\text{ mA}, I_B = 2\text{ mA}$		V_{BEsat}	—	—	0.9	

AC characteristics

Transition frequency $I_C = 10\text{ mA}, V_{CE} = 20\text{ V}, f = 100\text{ MHz}$		f_T	50	—	—	MHz
Output capacitance $V_{CB} = 20\text{ V}, f = 1\text{ MHz}$	SMBTA 92 SMBTA 93	C_{obo}	— —	— —	6 8	pF

¹⁾ Pulse test conditions: $t \leq 300\text{ }\mu\text{s}, D = 2\text{ }%$.

Total power dissipation $P_{tot} = f(T_A^*; T_S)$

* Package mounted on epoxy

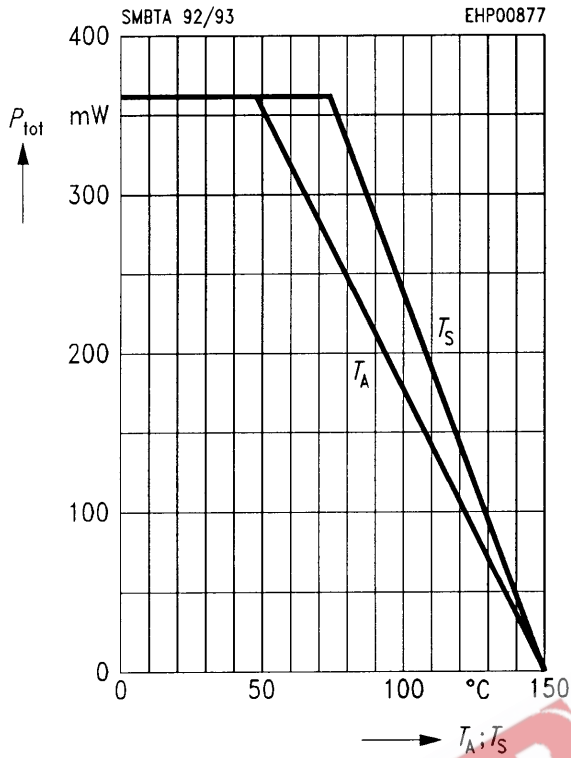

Transition frequency $f_T = f(I_C)$

$V_{CE} = 20$ V, $f = 100$ MHz

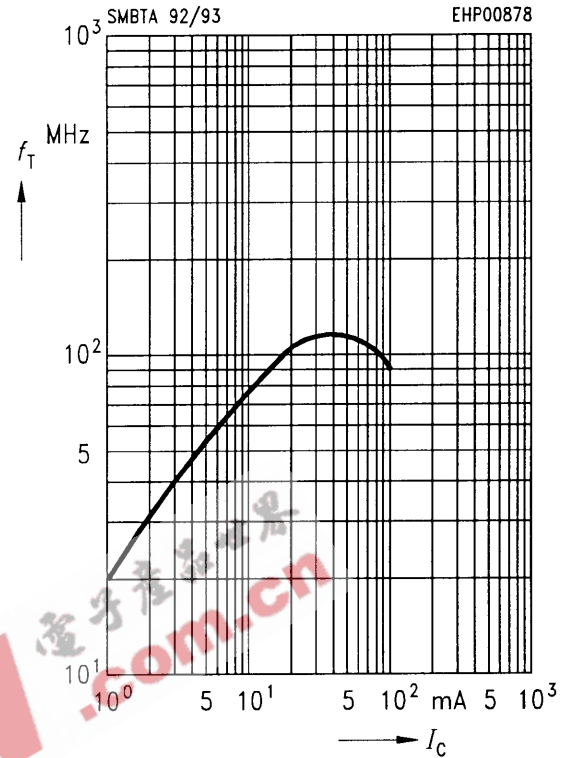

Permissible pulse load $P_{tot max}/P_{tot DC} = f(t_p)$

Operating range $I_C = f(V_{CE0})$

$T_A = 25$ °C, $D = 0$

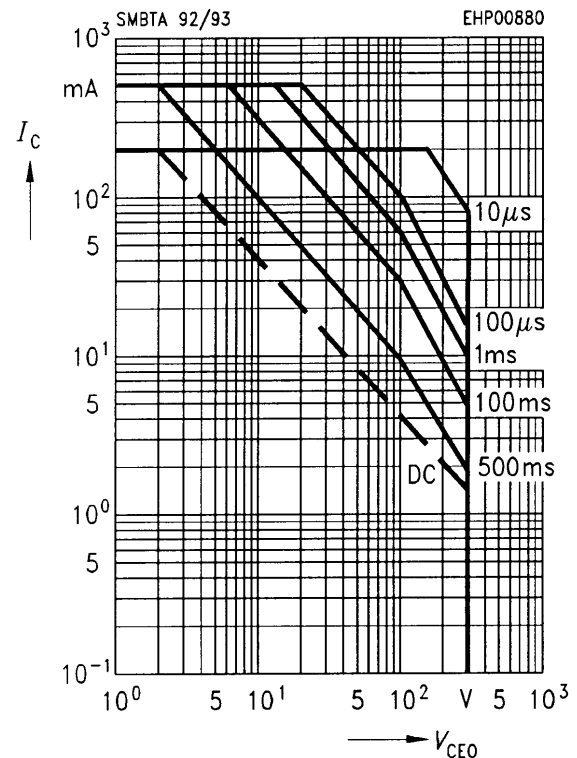
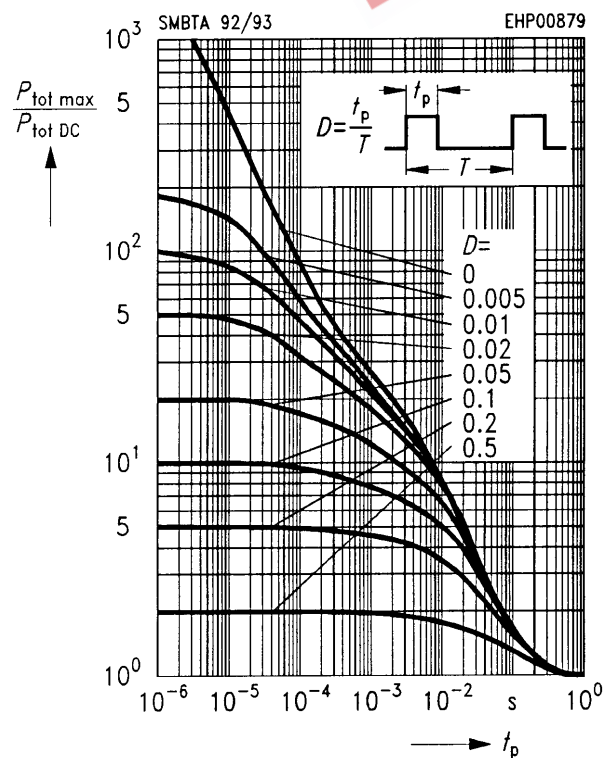

Collector cutoff current $I_{CB0} = f(T_A)$
 $V_{CB} = 160 \text{ V}$

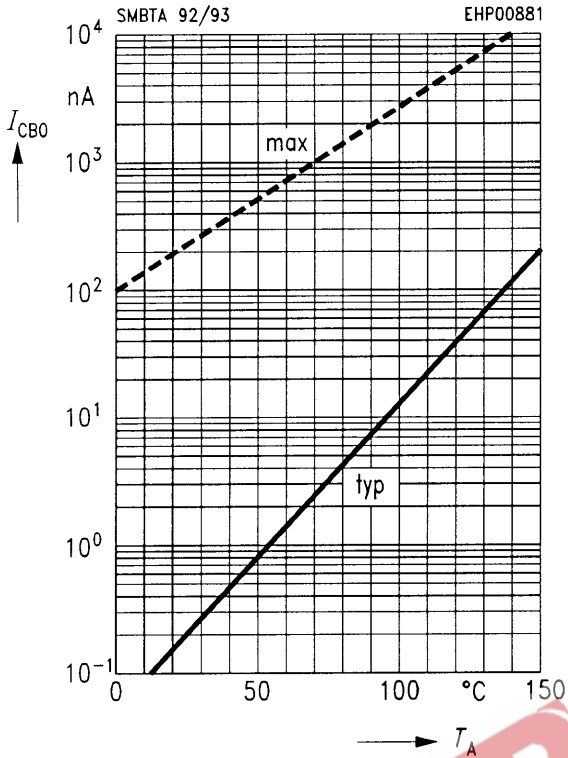

Collector current $I_C = f(V_{BE})$
 $V_{CE} = 10 \text{ V}$

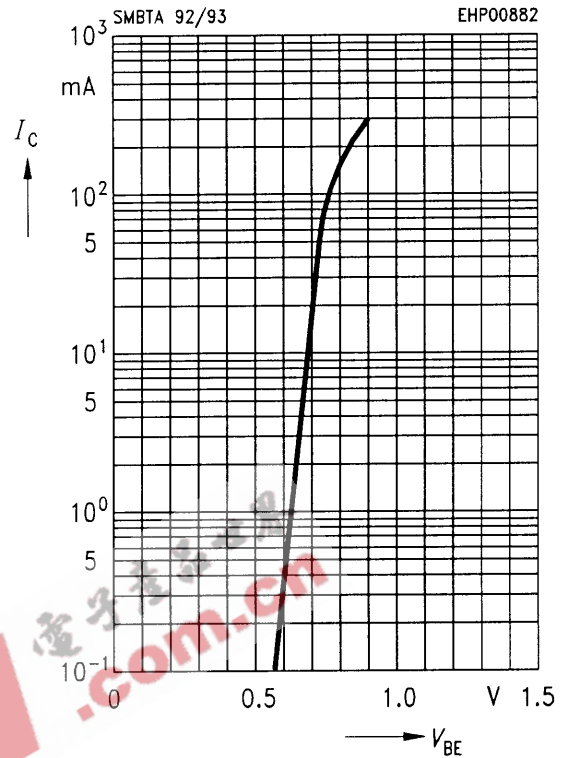

DC current gain $h_{FE} = f(I_C)$
 $V_{CE} = 10 \text{ V}$

