



DC COMPONENTS CO., LTD.

RECTIFIER SPECIALISTS

SS12
THRU
SS18

TECHNICAL SPECIFICATIONS OF SURFACE MOUNT SCHOTTKY BARRIER RECTIFIER

VOLTAGE RANGE - 20 to 80 Volts

CURRENT - 1.0 Ampere

FEATURES

- * Ideal for surface mounted applications
- * Low leakage current
- * Glass passivated junction

MECHANICAL DATA

- * Case: Molded plastic
- * Epoxy: UL 94V-0 rate flame retardant
- * Terminals: Solder plated solderable per MIL-STD-750, Method 2026
- * Polarity: As marked
- * Mounting position: Any
- * Weight: 0.064 gram

MAXIMUM RATINGS AND ELECTRICAL CHARACTERISTICS

Ratings at 25 °C ambient temperature unless otherwise specified.
Single phase, half wave, 60 Hz, resistive or inductive load.
For capacitive load, derate current by 20%.

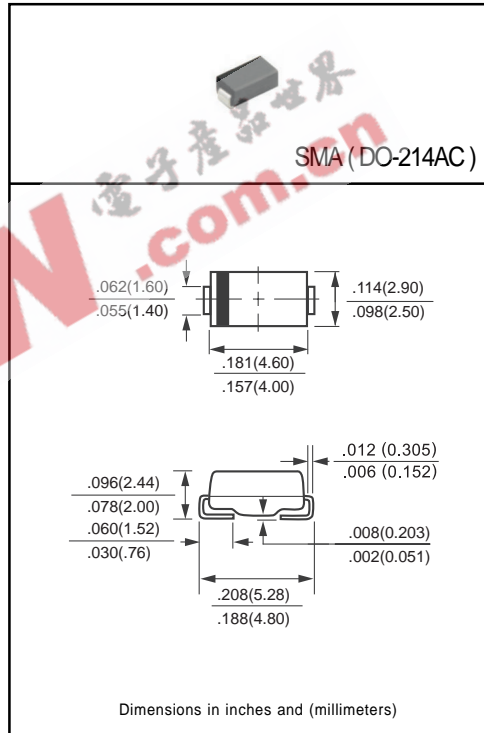

| | SYMBOL | SS12 | SS13 | SS14 | SS15 | SS16 | SS18 | UNITS |
|---|--------|--------------|------|------|------|------|------|-------|
| Maximum Recurrent Peak Reverse Voltage | VRRM | 20 | 30 | 40 | 50 | 60 | 80 | Volts |
| Maximum RMS Voltage | VRMS | 14 | 21 | 28 | 35 | 42 | 56 | Volts |
| Maximum DC Blocking Voltage | VDC | 20 | 30 | 40 | 50 | 60 | 80 | Volts |
| Maximum Average Forward Rectified Current at Derating Lead Temperature | IO | 1.0 | | | | | | Amps |
| Peak Forward Surge Current 8.3 ms single half sine-wave superimposed on rated load (JEDEC Method) | IFSM | 30 | | | | | | Amps |
| Maximum Instantaneous Forward Voltage at 1.0A DC | VF | 0.55 | | 0.70 | | 0.85 | | Volts |
| Maximum DC Reverse Current at Rated DC Blocking Voltage | IR | @TA = 25°C | | | | | | mAmps |
| | | 1.0 | | | | | | |
| Typical Thermal Resistance (Note 1) | RθJA | @TA = 100°C | | | | | | °C/W |
| | | 20 | | | | | | |
| Typical Junction Capacitance (Note 2) | CJ | 88 | | | | | | pF |
| Operating Temperature Range | TJ | 110 | | | | | | °C |
| Storage Temperature Range | TSTG | -65 to + 125 | | | | | | °C |
| | | -65 to + 150 | | | | | | °C |

- NOTES : 1. Thermal Resistance (Junction to Ambient).
2. Measured at 1 MHz and applied reverse voltage of 4.0 volts.
3. P.C.B Mounted with 0.2X0.2"(5.0X5.0mm²) copper pad area.

RATING AND CHARACTERISTIC CURVES (SS12 THRU SS18)

FIG. 1 - TYPICAL FORWARD CURRENT DERATING CURVE

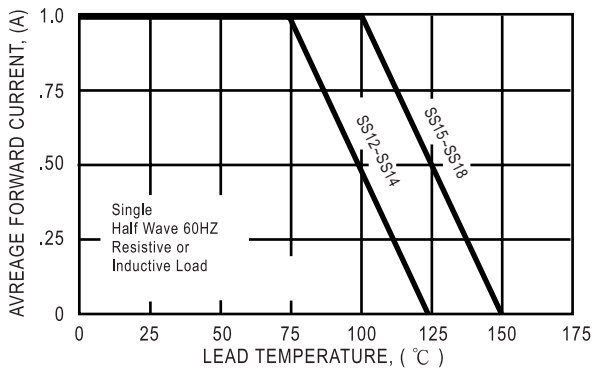

FIG. 2 - TYPICAL INSTANTANEOUS FORWARD CHARACTERISTICS

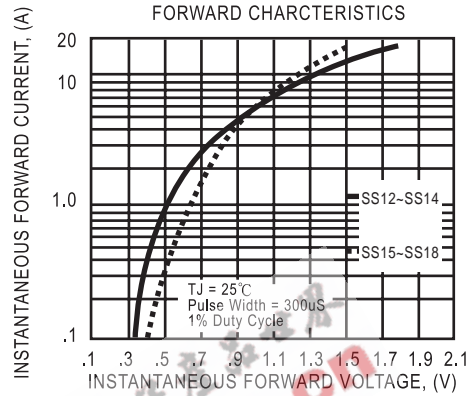

FIG. 3A - TYPICAL REVERSE CHARACTERISTICS

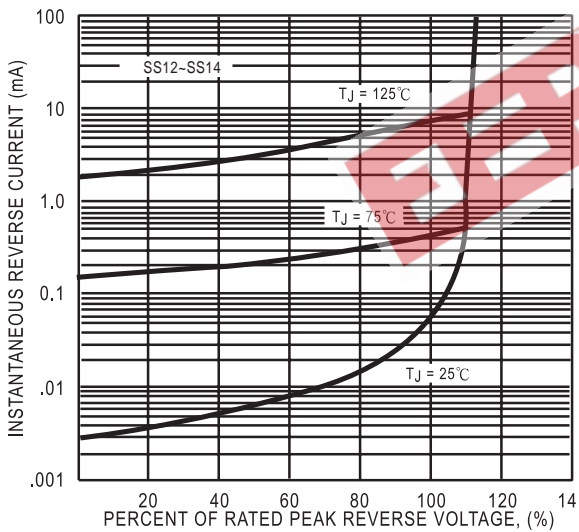

FIG. 3 - TYPICAL REVERSE CHARACTERISTICS

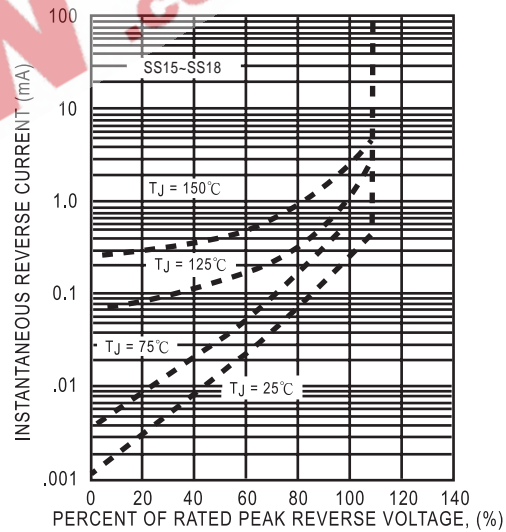

FIG. 4 - TYPICAL JUNCTION CAPACITANCE

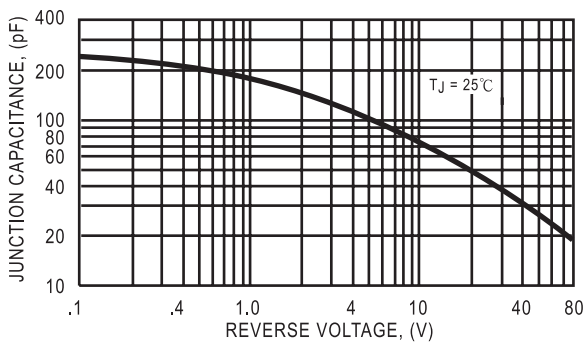
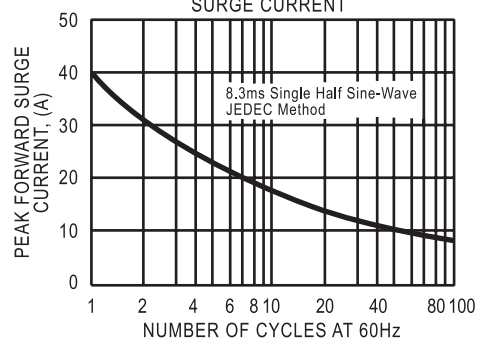

FIG. 5 - MAXIMUM NON-REPETITIVE FORWARD SURGE CURRENT



DC COMPONENTS CO., LTD.