

## PHASE CONTROL THYRISTORS

## Hockey Puk Version

### Features

- Center amplifying gate
- Metal case with ceramic insulator
- International standard case A-24 (K-PUK)
- High profile hockey-puk

1473A

### Typical Applications

- DC motor controls
- Controlled DC power supplies
- AC controllers

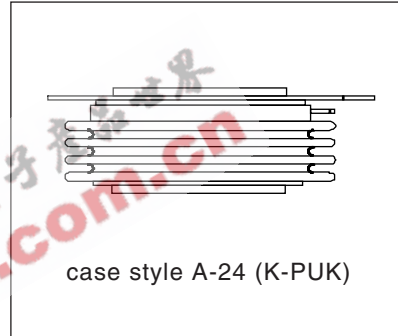

### Major Ratings and Characteristics

Parameters	ST1000C..K	Units	
$I_{T(AV)}$	1473	A	
@ $T_{hs}$	55	°C	
$I_{T(RMS)}$	2913	A	
@ $T_{hs}$	25	°C	
$I_{TSM}$	@ 50Hz	20.0	KA
	@ 60Hz	21.2	KA
$i^2t$	@ 50Hz	2000	KA <sup>2</sup> s
	@ 60Hz	1865	KA <sup>2</sup> s
$i^2\sqrt{t}$		20000	KA <sup>2</sup> /s
$V_{DRM}/V_{RRM}$ range	1200 to 2600	V	
$t_q$ typical	300	µs	
$T_J$ range	-40 to 125	°C	

**ELECTRICAL SPECIFICATIONS**

Voltage Ratings

Type number	Voltage Code	$V_{RRM}$ , maximum repetitive peak reverse voltage V	$V_{RSM}$ , maximum non-repetitive peak rev. voltage V	$I_{RRM}$ max. @ $T_J = 125^\circ\text{C}$ mA
ST1000C..K	12	1200	1300	100
	16	1600	1700	
	20	2000	2100	
	22	2200	2300	
	24	2400	2500	
	26	2600	2700	

On-state Conduction

Parameter	ST1000C..K	Units	Conditions
$I_{T(AV)}$ Maximum average on-state current @ Heatsink temperature	1473 (630)	A	180° conduction, half sine wave Double side (single side) cooled
	55 (85)	$^\circ\text{C}$	
$I_{T(RMS)}$ Maximum RMS on-state current	6540	A	DC @ 25°C heatsink temp. double side cooled
$I_{TSM}$ Maximum peak, one-cycle, non-repetitive surge current	20.0	KA	t = 10ms No voltage
	21.2		t = 8.3ms reapplied
	17.0		t = 10ms 100% $V_{RRM}$
	18.1		t = 8.3ms reapplied
$I^2t$ Maximum $I^2t$ for fusing	2000	KA <sup>2</sup> s	t = 10ms No voltage
	1865		t = 8.3ms reapplied
	1445		t = 10ms 100% $V_{RRM}$
	1360		t = 8.3ms reapplied
$I^2\sqrt{t}$ Maximum $I^2\sqrt{t}$ for fusing	20000	KA <sup>2</sup> $\sqrt{s}$	t = 0.1 to 10ms, no voltage reapplied
$V_{T(TO)1}$ Low level value of threshold voltage	0.950	V	$(16.7\% \times \pi \times I_{T(AV)} < I < \pi \times I_{T(AV)})$ , $T_J = T_J$ max.
$V_{T(TO)2}$ High level value of threshold voltage	1.024		$(I > \pi \times I_{T(AV)})$ , $T_J = T_J$ max.
$r_{t1}$ Low level value of on-state slope resistance	0.283	m $\Omega$	$(16.7\% \times \pi \times I_{T(AV)} < I < \pi \times I_{T(AV)})$ , $T_J = T_J$ max.
$r_{t2}$ High level value of on-state slope resistance	0.265		$(I > \pi \times I_{T(AV)})$ , $T_J = T_J$ max.
$V_{TM}$ Maximum on-state voltage drop	1.80	V	$I_{pk} = 3000\text{A}$ , $T_J = 125^\circ\text{C}$ , $t_p = 10\text{ms}$ sine pulse
$I_H$ Maximum holding current	600	mA	$T_J = 25^\circ\text{C}$ , anode supply 12V resistive load
$I_L$ Typical latching current	1000		

Switching

Parameter	ST1000C..K	Units	Conditions
di/dt Maximum non repetitive rate of rise of turned-on current	1000	A/μs	Gate drive 20V, 20Ω, t <sub>r</sub> ≤ 1μs T <sub>J</sub> = T <sub>J</sub> max., anode voltage ≤ 80% V <sub>DRM</sub>
t <sub>d</sub> Typical delay time	1.9	μs	Gate current 1A, di <sub>g</sub> /dt = 1A/μs V <sub>d</sub> = 0.67% V <sub>DRM</sub> , T <sub>J</sub> = 25°C
t <sub>q</sub> Typical turn-off time	300	A/μs	I <sub>TM</sub> = 550A, T <sub>J</sub> = T <sub>J</sub> max, di/dt = 40A/μs, V <sub>r</sub> = 50V dv/dt = 20V/μs, Gate 0V 100Ω, t <sub>p</sub> ≤ 500μs

Blocking

Parameter	ST1000C..K	Units	Conditions
dv/dt Maximum critical rate of rise of off-state voltage	500	V/μs	T <sub>J</sub> = T <sub>J</sub> max., linear to 80% rated V <sub>DRM</sub>
I <sub>RRM</sub> I <sub>DRM</sub> Maximum peak reverse and off-state leakage current	100	μs	T <sub>J</sub> = T <sub>J</sub> max., rated V <sub>DRM</sub> /V <sub>RRM</sub> applied

Triggering

Parameter	ST1000C..K		Units	Conditions
P <sub>GM</sub> Maximum peak gate power	16		W	T <sub>J</sub> = T <sub>J</sub> max., t <sub>p</sub> ≤ 5ms
P <sub>G(AV)</sub> Maximum peak average gate power	3		W	T <sub>J</sub> = T <sub>J</sub> max., f = 50Hz, d% = 50
I <sub>GM</sub> Maximum peak positive gate current	3.0		A	T <sub>J</sub> = T <sub>J</sub> max., t <sub>p</sub> ≤ 5ms
+V <sub>GM</sub> Maximum peak positive gate voltage	20		V	T <sub>J</sub> = T <sub>J</sub> max., t <sub>p</sub> ≤ 5ms
-V <sub>GM</sub> Maximum peak negative gate voltage	5.0		V	
I <sub>GT</sub> DC gate current required to trigger	TYP.	MAX.	mA	
	200	-		
	100	200		
V <sub>GT</sub> DC gate voltage required to trigger	1.4	-	V	T <sub>J</sub> = -40°C T <sub>J</sub> = 25°C T <sub>J</sub> = 125°C
	1.1	3.0		
	0.9	-		
I <sub>GD</sub> DC gate current not to trigger	10		mA	T <sub>J</sub> = T <sub>J</sub> max. Max. gate current / voltage not to trigger is the max. value which will not trigger any units with rated V <sub>DRM</sub> anode-to-cathode applied
V <sub>GD</sub> DC gate voltage not to trigger	0.25		V	

## ST1000C..K Series

Bulletin I25202 rev. A 01/00

International  
IOR Rectifier

### Thermal and Mechanical Specifications

Parameter	ST1000C..K	Units	Conditions
T <sub>J</sub> Max. junction operating temperature range	-40 to 125	°C	
T <sub>stg</sub> Max. storage temperature range	-40 to 150		
R <sub>thJ-hs</sub> Max. thermal resistance, junction to heatsink	0.042	K/W	DC operation single side cooled
	0.021		DC operation double side cooled
R <sub>thC-hs</sub> Max. thermal resistance, case to heatsink	0.006	K/W	DC operation single side cooled
	0.003		DC operation double side cooled
F Mounting force, ± 10%	24500 (2500)	N (Kg)	
wt Approximate weight	425	g	
Case style	A-24 (K-PUK)		See outline table

### $\Delta R_{thJC}$ Conduction

(The following table shows the increment of thermal resistance R<sub>thJC</sub> when devices operate at different conduction angles than DC)

Conduction angle	Sinusoidal conduction		Rectangular conduction		Units	Conditions
	Single Side	Double Side	Single Side	Double Side		
180°	0.003	0.003	0.002	0.002	K/W	T <sub>J</sub> = T <sub>J</sub> max.
120°	0.004	0.004	0.004	0.004		
90°	0.005	0.005	0.005	0.005		
60°	0.007	0.007	0.007	0.007		
30°	0.012	0.012	0.012	0.012		

### Ordering Information Table

Device Code							
ST	100	0	C	26	K	1	
①	②	③	④	⑤	⑥	⑦	⑧
<b>1</b>	- Thyristor	<b>2</b>	- Essential part number	<b>3</b>	- 0 = Converter grade	<b>4</b>	- C = Ceramic Puk
<b>5</b>	- Voltage code: Code x 100 = V <sub>RRM</sub> (See Voltage Ratings Table)	<b>6</b>	- K = Puk Case A-24 (K-PUK)	<b>7</b>	- 0 = Eyelet terminals (Gate and Auxiliary Cathode Unsoldered Leads)	1	= Fast-on terminals (Gate and Auxiliary Cathode Unsoldered Leads)
						2	= Eyelet terminals (Gate and Auxiliary Cathode Soldered Leads)
						3	= Fast-on terminals (Gate and Auxiliary Cathode Soldered Leads)
<b>8</b>	- Critical dv/dt: None = 500V/μsec (Standard selection)					L	= 1000V/μsec (Special selection)

Outline Table

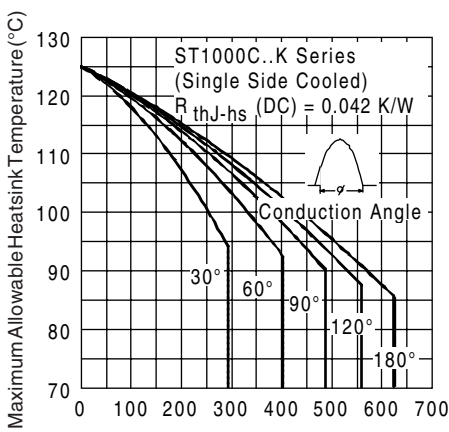
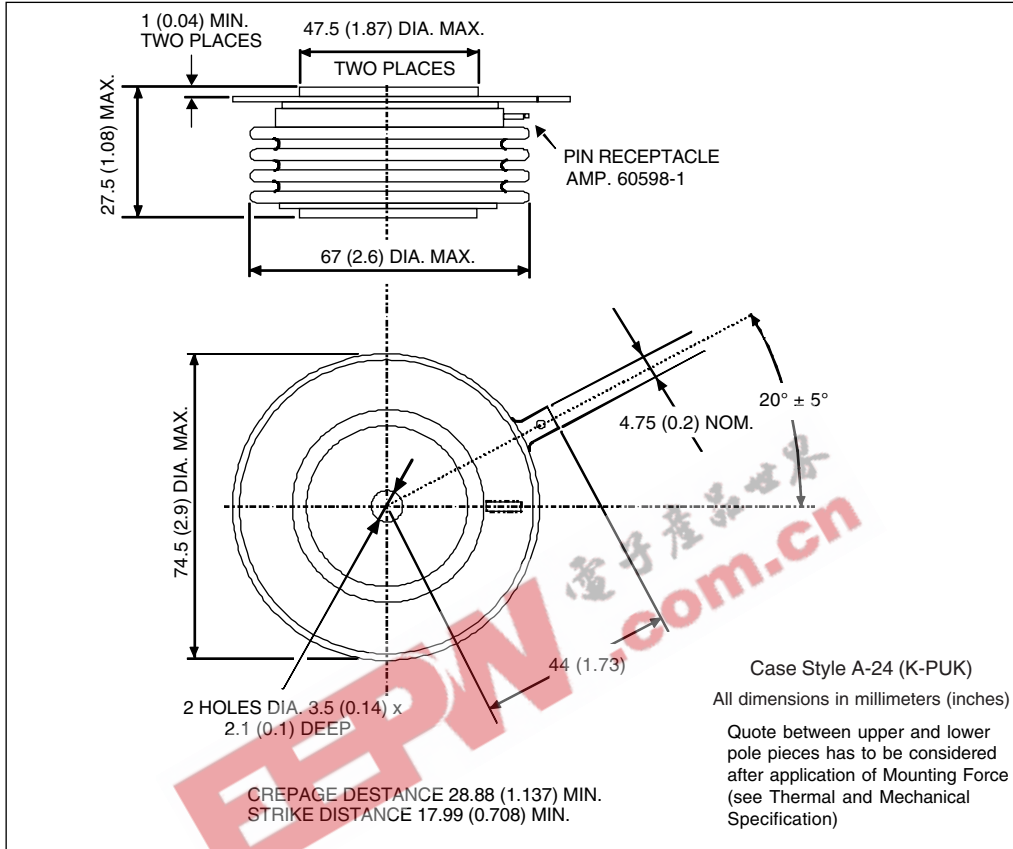

Fig. 1 - Current Ratings Characteristics

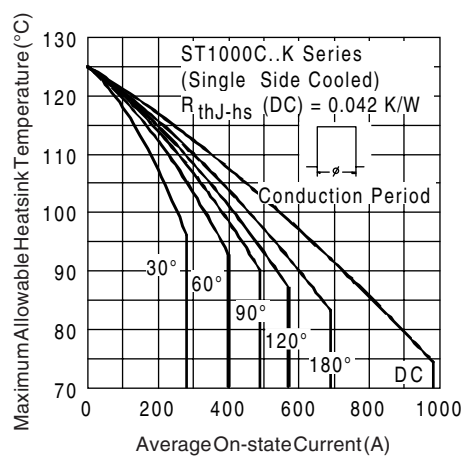

Fig. 2 - Current Ratings Characteristics

# ST1000C..K Series

Bulletin I25202 rev. A 01/00

International  
**IRF** Rectifier

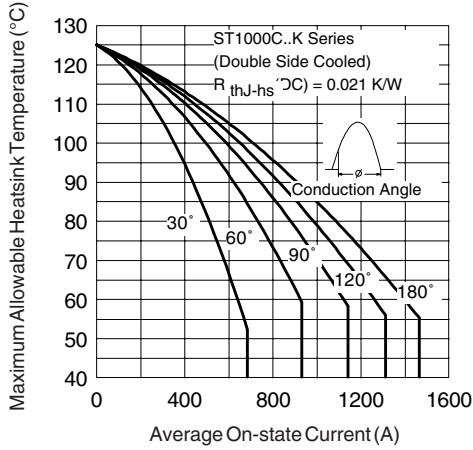

Fig. 3 - Current Ratings Characteristics

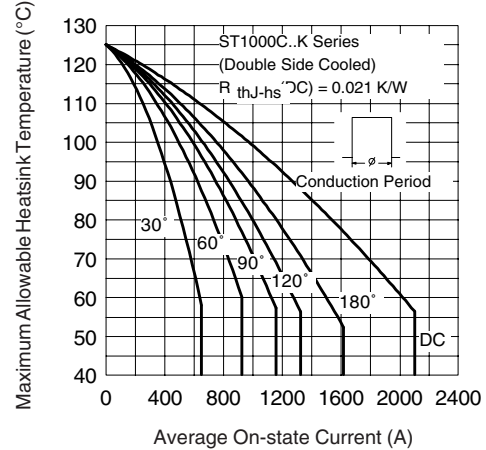

Fig. 4 - Current Ratings Characteristics

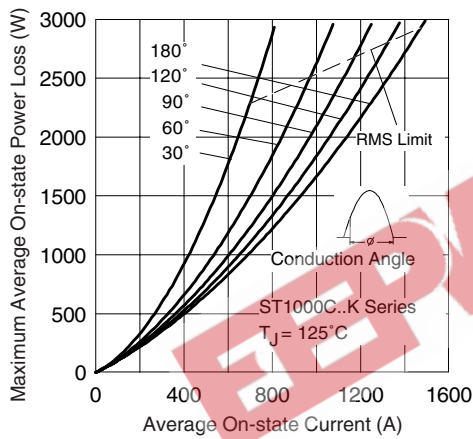

Fig. 5 - On-state Power Loss Characteristics

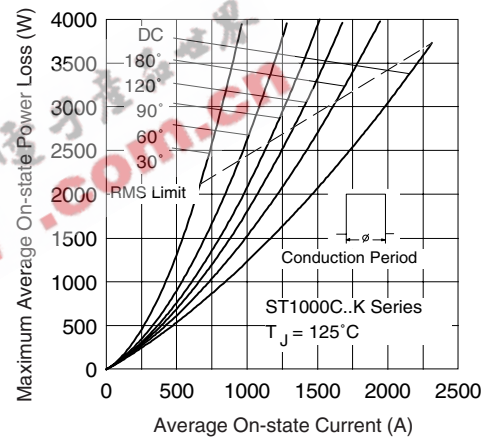

Fig. 6 - On-state Power Loss Characteristics

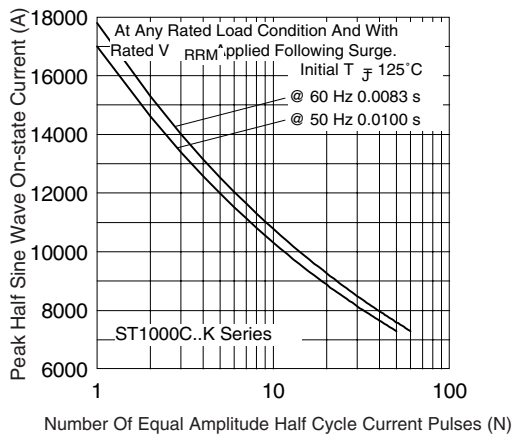

Fig. 7 - Maximum Non-Repetitive Surge Current Single and Double Side Cooled

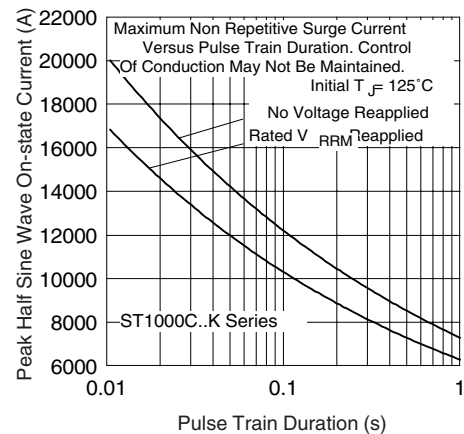

Fig. 8 - Maximum Non-Repetitive Surge Current Single and Double Side Cooled

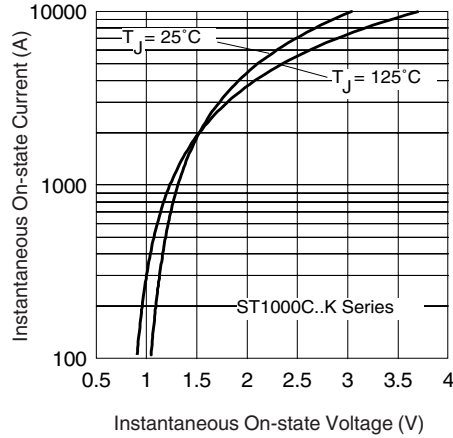

Fig. 9 - On-state Voltage Drop Characteristics

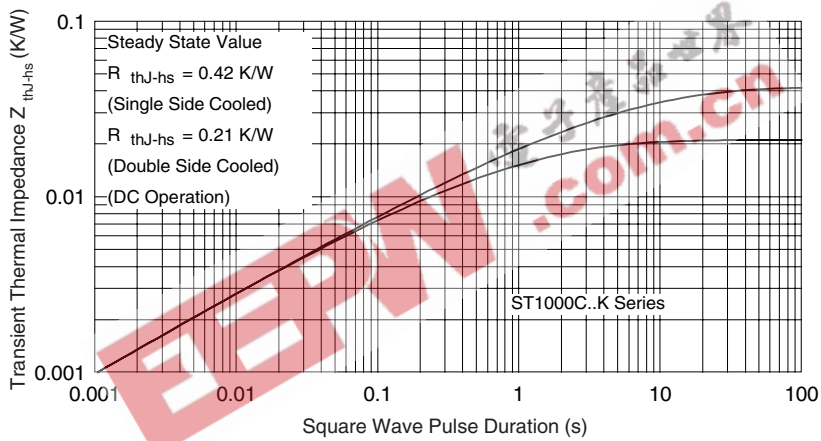

Fig. 10 - Thermal Impedance  $Z_{thJ-hs}$  Characteristics

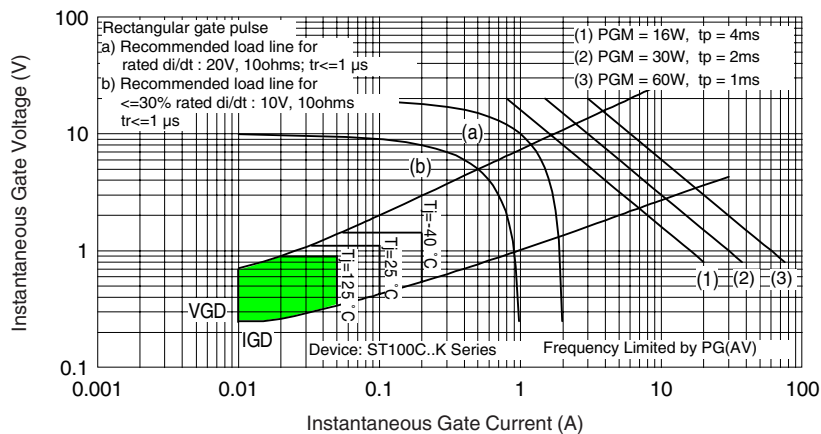

Fig. 11 - Gate Characteristics