

PHASE CONTROL THYRISTORS

Hockey Puk Version

Features

- Center amplifying gate
- Metal case with ceramic insulator
- International standard case TO-200AB (E-PUK)
- Low profile hockey-puk to increase current-carrying capability
- Extended temperature range
- Lead Free

960A

Typical Applications

- DC motor controls
- Controlled DC power supplies
- AC controllers

Major Ratings and Characteristics

Parameters	ST380CH..C	Units	
$I_{T(AV)}$	960	A	
@ T_{hs}	80	°C	
$I_{T(RMS)}$	2220	A	
@ T_{hs}	25	°C	
I_{TSM}	@ 50Hz	12500	A
	@ 60Hz	13000	A
I^2t	@ 50Hz	782	KA ² s
	@ 60Hz	713	KA ² s
V_{DRM}/V_{RRM}	400 to 600	V	
t_q	typical	100	μs
T_J	- 40 to 150	°C	

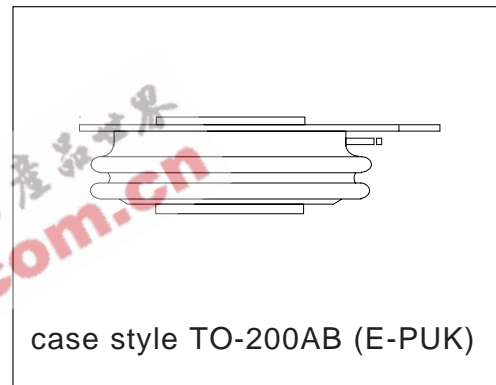

ELECTRICAL SPECIFICATIONS

Voltage Ratings

Type number	Voltage Code	V_{DRM}/V_{RRM} , max. repetitive peak and off-state voltage V	V_{RSM} , maximum non-repetitive peak voltage V	I_{DRM}/I_{RRM} max. @ $T_J = T_J$ max mA
ST380CH..C	04	400	500	100
	06	600	700	

On-state Conduction

Parameter	ST380CH..C	Units	Conditions
$I_{T(AV)}$ Max. average on-state current @ Heatsink temperature	960 (440)	A	180° conduction, half sine wave double side (single side) cooled
	80 (110)	°C	
$I_{T(RMS)}$ Max. RMS on-state current	2220		DC @ 25°C heatsink temperature double side cooled
I_{TSM} Max. peak, one-cycle non-repetitive surge current	12500	A	t = 10ms No voltage
	13000		t = 8.3ms reapplied
	10500		t = 10ms 100% V_{RRM}
I^2t Maximum I^2t for fusing	11000	KA ² s	t = 8.3ms reapplied
	782		t = 10ms No voltage
	713		t = 8.3ms reapplied
	553		t = 10ms 100% V_{RRM}
	505		t = 8.3ms reapplied
$I^2\sqrt{t}$ Maximum $I^2\sqrt{t}$ for fusing	7820	KA ² √s	t = 0.1 to 10ms, no voltage reapplied
$V_{T(TO)1}$ Low level value of threshold voltage	0.85	V	(16.7% x π x $I_{T(AV)} < I < \pi$ x $I_{T(AV)}$), $T_J = T_J$ max.
	0.88		($I > \pi$ x $I_{T(AV)}$), $T_J = T_J$ max.
r_{t1} Low level value of on-state slope resistance	0.25	mΩ	(16.7% x π x $I_{T(AV)} < I < \pi$ x $I_{T(AV)}$), $T_J = T_J$ max.
	0.24		($I > \pi$ x $I_{T(AV)}$), $T_J = T_J$ max.
V_{TM} Max. on-state voltage	1.58	V	$I_{pk} = 2900A$, $T_J = T_J$ max, $t_p = 10ms$ sine pulse $T_J = 25^\circ C$, anode supply 12V resistive load
I_H Maximum holding current	600	mA	
I_L Typical latching current	1000		

Switching

Parameter	ST380CH..C	Units	Conditions
di/dt Max. non-repetitive rate of rise of turned-on current	1000	A/μs	Gate drive 20V, 20Ω, $t_r \leq 1\mu s$ $T_J = T_J$ max, anode voltage $\leq 80\%$ V_{DRM}
t_d Typical delay time	1.0	μs	Gate current 1A, $di_g/dt = 1A/\mu s$ $V_d = 0.67\%$ V_{DRM} , $T_J = 25^\circ C$
t_q Typical turn-off time	100		$I_{TM} = 550A$, $T_J = T_J$ max, $di/dt = 40A/\mu s$, $V_R = 50V$ $dv/dt = 20V/\mu s$, Gate 0V 100Ω, $t_p = 500\mu s$

Blocking

Parameter	ST380CH..C	Units	Conditions
dv/dt Maximum critical rate of rise of	500 off-state voltage	V/ μ s	$T_J = T_J$ max. linear to 80% rated V_{DRM}
I_{RRM} I_{DRM} Max. peak reverse and off-state leakage current	100	mA	$T_J = T_J$ max, rated V_{DRM}/V_{RRM} applied

Triggering

Parameter	ST380CH..C	Units	Conditions		
P_{GM} Maximum peak gate power	10.0	W	$T_J = T_J$ max, $t_p \leq 5$ ms		
$P_{G(AV)}$ Maximum average gate power	2.0		$T_J = T_J$ max, $f = 50$ Hz, $d\% = 50$		
I_{GM} Max. peak positive gate current	3.0	A	$T_J = T_J$ max, $t_p \leq 5$ ms		
$+V_{GM}$ Maximum peak positive gate voltage	20	V	$T_J = T_J$ max, $t_p \leq 5$ ms		
$-V_{GM}$ Maximum peak negative gate voltage	5.0				
I_{GT} DC gate current required to trigger	TYP.	MAX.	mA	Max. required gate trigger/ current/ voltage are the lowest value which will trigger all units 12V anode-to-cathode applied	
	200	-			$T_J = -40^\circ\text{C}$
	100	200			$T_J = 25^\circ\text{C}$
V_{GT} DC gate voltage required to trigger	40	-	V	$T_J = 150^\circ\text{C}$	
	2.5	-			$T_J = -40^\circ\text{C}$
	1.8	3.0			$T_J = 25^\circ\text{C}$
I_{GD} DC gate current not to trigger	10	mA	$T_J = T_J$ max	Max. gate current/voltage not to trigger is the max. value which will not trigger any unit with rated V_{DRM} anode-to-cathode applied	
	0.25				$T_J = 150^\circ\text{C}$
V_{GD} DC gate voltage not to trigger		V			

Thermal and Mechanical Specification

Parameter	ST380CH..C	Units	Conditions
T_J Max. operating temperature range	-40 to 150	$^\circ\text{C}$	
T_{stg} Max. storage temperature range	-40 to 150		
R_{thJ-hs} Max. thermal resistance, junction to heatsink	0.09	K/W	DC operation single side cooled
	0.04		DC operation double side cooled
R_{thC-hs} Max. thermal resistance, case to heatsink	0.02	K/W	DC operation single side cooled
	0.01		DC operation double side cooled
F Mounting force, $\pm 10\%$	9800	N	
	(1000)	(Kg)	
wt Approximate weight	83	g	
Case style	TO-200AB (E-PUK)		See Outline Table

ΔR_{thJ-hs} Conduction

(The following table shows the increment of thermal resistance R_{thJ-hs} when devices operate at different conduction angles than DC)

Conduction angle	Sinusoidal conduction		Rectangular conduction		Units	Conditions
	Single Side	Double Side	Single Side	Double Side		
180°	0.010	0.011	0.007	0.007	K/W	$T_J = T_{J \text{ max.}}$
120°	0.012	0.012	0.012	0.013		
90°	0.015	0.015	0.016	0.017		
60°	0.022	0.022	0.023	0.023		
30°	0.036	0.036	0.036	0.037		

Ordering Information Table

Device Code

ST	38	0	CH	06	C	1	PbF	
1	2	3	4	5	6	7	8	9

- 1** - Thyristor
- 2** - Essential part number
- 3** - 0= Converter grade
- 4** - CH = Ceramic Puk, High temperature
- 5** - Voltage code: Code x 100 = V_{RRM} (See Voltage Rating Table)
- 6** - C = Puk Case TO-200AB (E-PUK)
- 7** - 0 = Eyelet terminals (Gate and Auxiliary Cathode Unsoldered Leads)
 1 = Fast-on terminals (Gate and Auxiliary Cathode Unsoldered Leads)
 2 = Eyelet terminals (Gate and Auxiliary Cathode Soldered Leads)
 3 = Fast-on terminals (Gate and Auxiliary Cathode Soldered Leads)
- 8** - Critical dv/dt: None = 500V/ μ sec (Standard selection)
 L = 1000V/ μ sec (Special selection)
- 9** - Lead Free

Outline Table

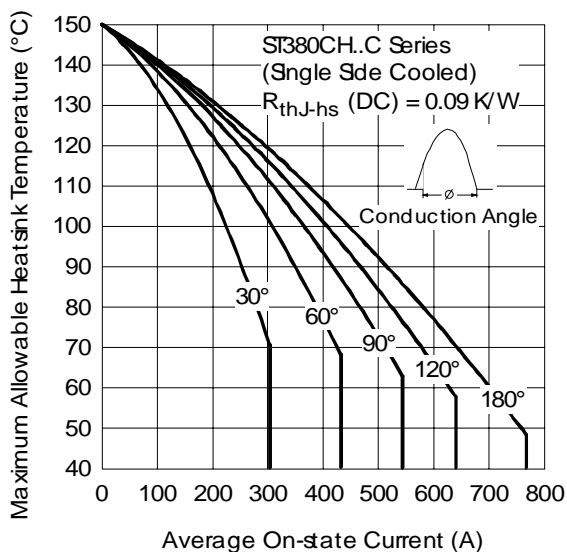
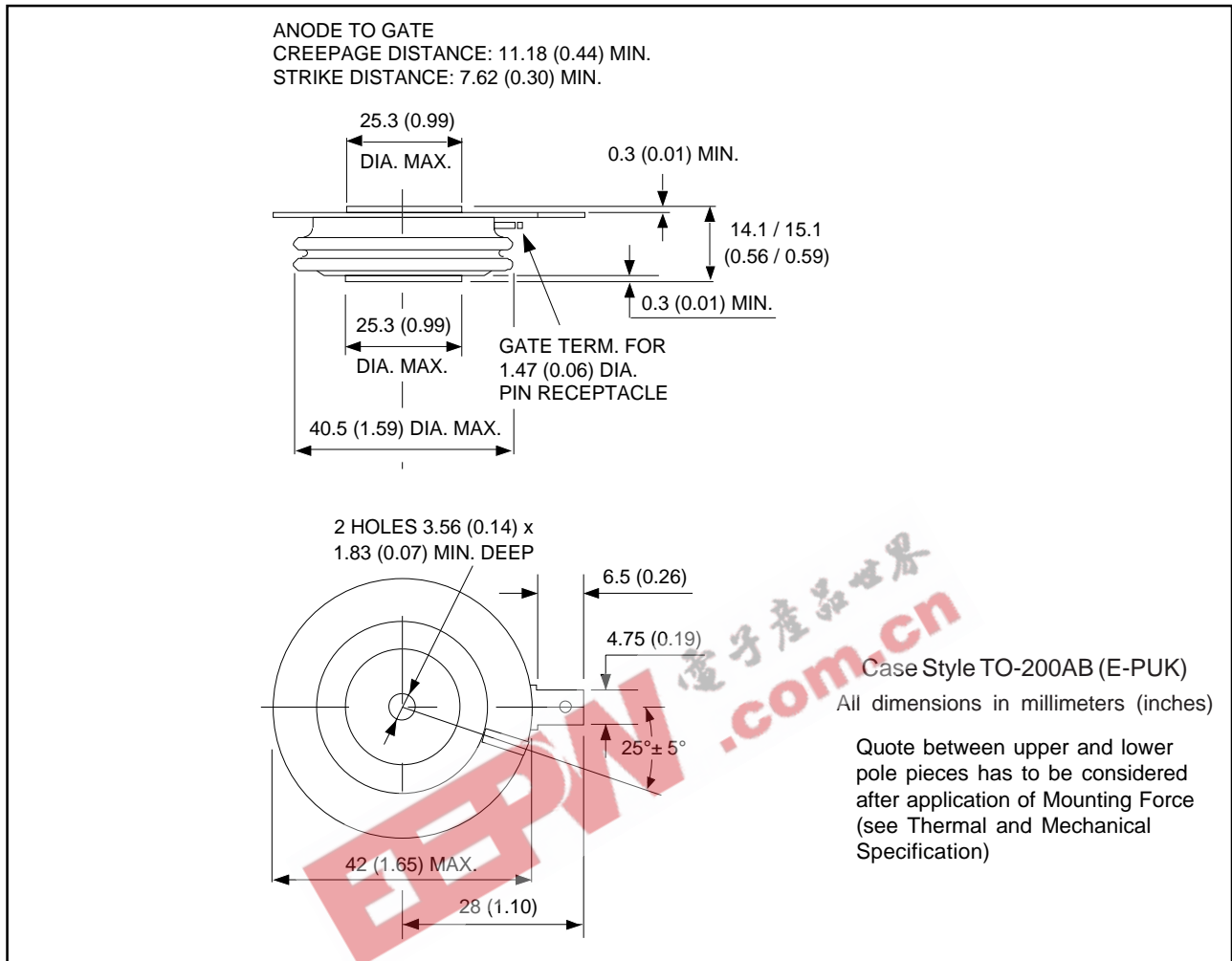

Fig. 1 - Current Ratings Characteristics

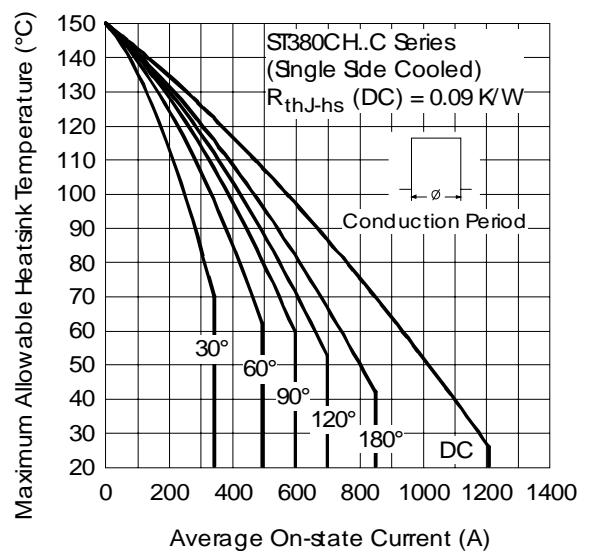

Fig. 2 - Current Ratings Characteristics

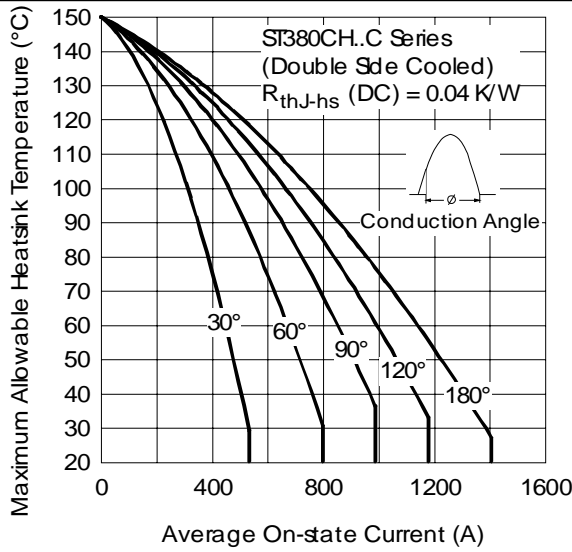

Fig. 3 - Current Ratings Characteristics

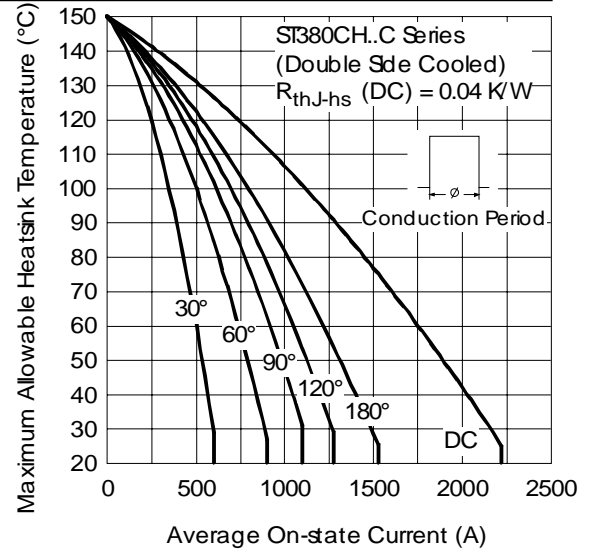

Fig. 4 - Current Ratings Characteristics

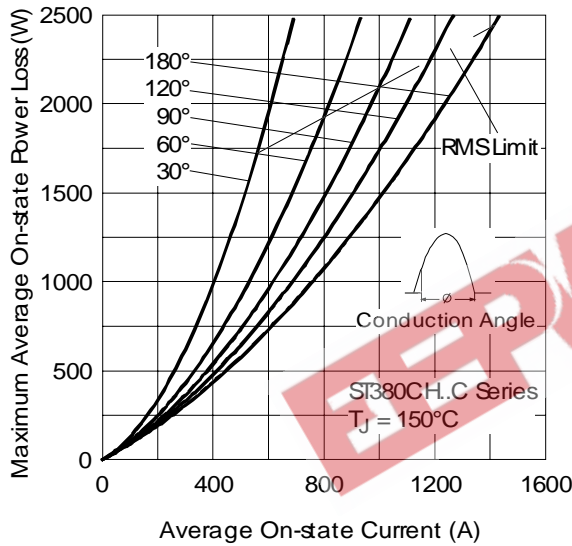

Fig. 5- On-state Power Loss Characteristics

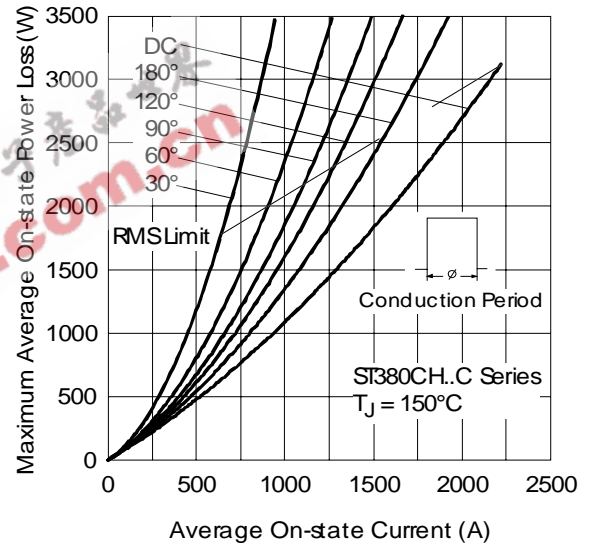

Fig. 6- On-state Power Loss Characteristics

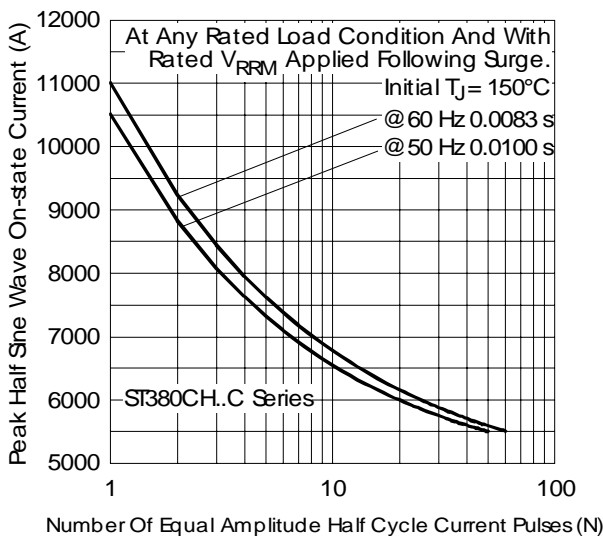

Fig. 7 - Maximum Non-Repetitive Surge Current Single and Double Side Cooled

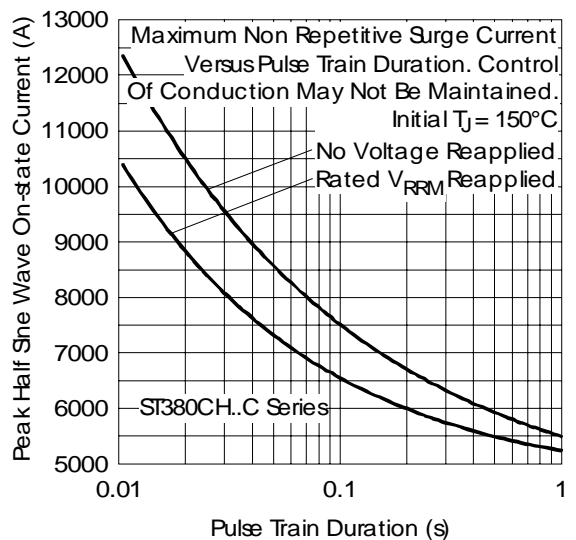

Fig. 8 - Maximum Non-Repetitive Surge Current Single and Double Side Cooled

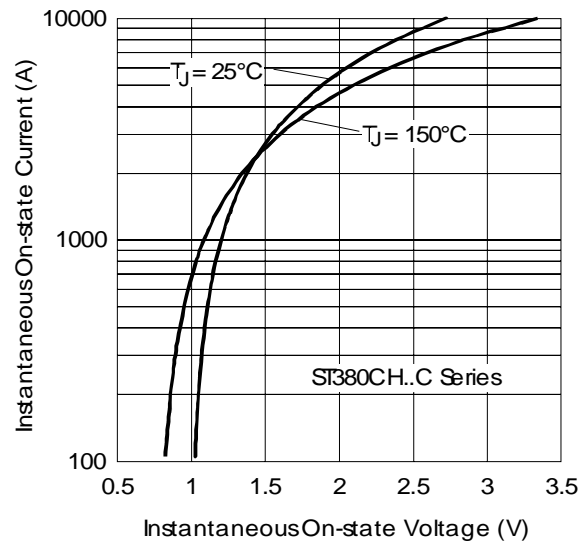

Fig. 9 - On-state Voltage Drop Characteristics

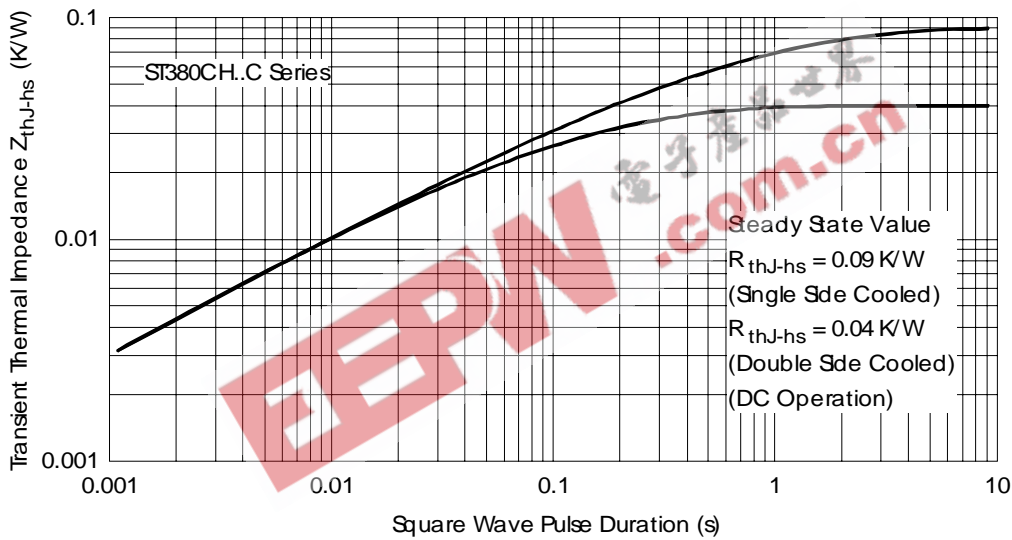

Fig. 10 - Thermal Impedance Z_{thJ-hs} Characteristics

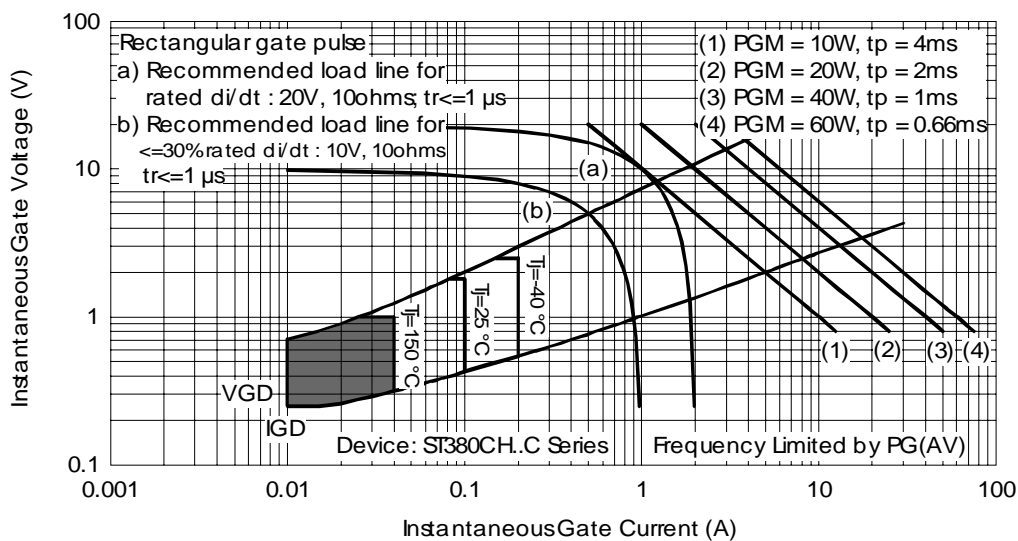

Fig. 11 - Gate Characteristics

ST380CHPbF Series

Bulletin I25227 09/06

International
IR Rectifier

EEPW 电子產品世界
.com.cn

Data and specifications subject to change without notice.
This product has been designed and qualified for Industrial Level.
Qualification Standards can be found on IR's Web site.

International
IR Rectifier

IR WORLD HEADQUARTERS: 233 Kansas St., El Segundo, California 90245, USA Tel: (310) 252-7105
TAC Fax: (310) 252-7309

Visit us at www.irf.com for sales contact information. 09/06