

PHASE CONTROL THYRISTORS

Hockey Puk Version

Features

- Double side cooling
- High surge capability
- High mean current
- Fatigue free

Typical Applications

- DC motor controls
- Controlled DC power supplies
- AC controllers

2090A

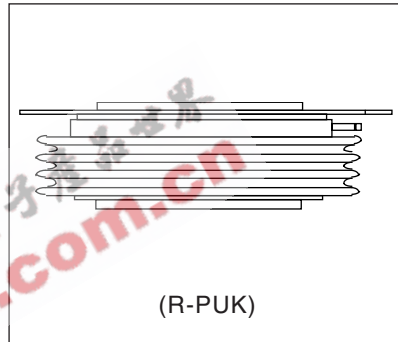

Major Ratings and Characteristics

Parameters	ST2100C..R	Units	
$I_{T(AV)}$	1770	A	
@ T_C	80	°C	
$I_{T(AV)}$	2090	A	
@ T_{hs}	55	°C	
$I_{T(RMS)}$	3850	A	
@ T_{hs}	25	°C	
I_{TSM}	@ 50Hz	36250	A
	@ 60Hz	38000	A
i^2t	@ 50Hz	6570	KA ² s
	@ 60Hz	5990	KA ² s
V_{DRM}/V_{RRM}	3000 to 4200	V	
t_q	typical	500	μs
T_J	max.	125	°C

ST2100C..R Series

Bulletin I25198 rev. B 02/00

International
 Rectifier

ELECTRICAL SPECIFICATIONS

Voltage Ratings

Type number	Voltage Code	V_{DRM}/V_{RRM} , max. repetitive peak and off-state voltage V	V_{RSM} , maximum non-repetitive peak voltage V	I_{DRM}/I_{RRM} max. @ $T_C = 125^\circ\text{C}$ mA
ST2100C..R	30	3000	3100	250
	32	3200	3300	
	34	3400	3500	
	36	3600	3700	
	38	3800	3900	
	40	4000	4100	
	42	4200	4300	

On-state Conduction

Parameter	ST2100C..R	Units	Conditions
$I_{T(AV)}$ Max. average on-state current @ Case temperature	1770 (1150)	A	180° conduction, half sine wave double side (single side [anode side] cooled)
	80	°C	
$I_{T(AV)}$ Max. average on-state current @ Heatsink temperature	2090 (940)	A	
	55 (85)	°C	
$I_{T(RMS)}$ Max. RMS on-state current	3850	A	DC @ 25°C heatsink temperature double side cooled
I_{TSM} Max. peak, one-cycle non-repetitive surge current	36250	A	t = 10ms No voltage
	38000		t = 8.3ms reapplied
	29000		t = 10ms 50% V_{RRM}
	30350		t = 8.3ms reapplied
I^2t Maximum I^2t for fusing	6570	KA ² s	t = 10ms No voltage
	5990		t = 8.3ms reapplied
	4205		t = 10ms 50% V_{RRM}
	3820		t = 8.3ms reapplied
$V_{T(TH)}$ Max. value of threshold voltage	1.03	V	$T_J = T_J$ max.
r_t Max. value of on-state slope resistance	0.32	mΩ	$T_J = T_J$ max.
V_{TM} Max. on-state voltage	1.875	V	$I_{pk} = 2900\text{A}$, $T_C = 25^\circ\text{C}$
I_L Typical latching current	300	mA	$T_J = 25^\circ\text{C}$, $V_D = 5\text{V}$

Switching

Parameter	ST2100C..R	Units	Conditions
di/dt Max. repetitive 50Hz (no repetitive) rate of rise of turned-on current	150 (300)	A/μs	From 67% V_{DRM} to 1000A gate drive 20V, 10Ω, $t_r = 0.5\mu\text{s}$ $T_J = T_J$ max.
t_d Maximum delay time	2.5	μs	Gate drive 30V, 15Ω, $V_d = 67\% V_{DRM}$, $T_J = 25^\circ\text{C}$ Rise time 0.5μs
t_q Typical turn-off time	500		$I_T = 1000\text{A}$, $t_p = 1\text{ms}$, $T_J = T_J$ max, $V_{RM} = 50\text{V}$, $dI_{RR}/dt = 2\text{A}/\mu\text{s}$, $V_{DR} = 67\% V_{DRM}$, $dV_{DR}/dt = 8\text{V}/\mu\text{s}$ linear

Blocking

Parameter	ST2100C..R	Units	Conditions
dv/dt Maximum linear rate of rise of off-state voltage	500	V/μs	T _J = T _J max. to 67% rated V _{DRM}
I _{RRM} I _{DRM} Max. peak reverse and off-state leakage current	250	mA	T _J = 125°C rated V _{DRM} /V _{RRM} applied

Triggering

Parameter	ST2100C..R	Units	Conditions
P _{GM} Maximum peak gate power	150	W	t _p = 100μs
P _{G(AV)} Maximum average gate power	10		
I _{GM} Max. peak positive gate current	30	A	Anode positive with respect to cathode
V _{GM} Max. peak positive gate voltage	30	V	Anode positive with respect to cathode
-V _{GM} Max. peak negative gate voltage	0.25	V	Anode positive with respect to cathode
I _{GT} Maximum DC gate current required to trigger	400	mA	T _C = 25°C, V _{DRM} = 5V
V _{GT} Maximum gate voltage required to trigger	4	V	T _C = 25°C, V _{DRM} = 5V
V _{GD} DC gate voltage not to trigger	0.25	V	T _C = 125°C Max. gate current/voltage not to trigger is the max. value which will not trigger any unit with rated V _{DRM} anode-to-cathode applied

Thermal and Mechanical Specification

Parameter	ST2100C..R	Units	Conditions	
T _J max. Max. operating temperature	125	°C	On-state (conducting)	
T _{stg} Max. storage temperature range	-55 to 125			
R _{thJ-C} Thermal resistance, junction to case	0.019 0.0095	K/W	DC operation single side cooled DC operation double side cooled	
R _{th(C-h)} Thermal resistance, case to heatsink	0.004 0.002	K/W	Single side cooled Double side cooled	Clamping force 43KN with mounting compound
F Mounting force ± 10%	43000 (4400)	N (Kg)		
wt Approximate weight	1600	g		
Case style	(R-PUK)		See Outline Table	

ΔR_{thJ-C} Conduction

(The following table shows the increment of thermal resistance R_{thJ-C} when devices operate at different conduction angles than DC)

Conduction angle	Single side	Double side	Units	Conditions
180°	0.0010	0.0010	K/W	T _J = T _J max.
120°	0.0017	0.0017		
60°	0.0044	0.0044		

ST2100C..R Series

Bulletin I25198 rev. B 02/00

International
IR Rectifier

Ordering Information Table

Device Code							
ST	210	0	C	42	R	1	
①	②	③	④	⑤	⑥	⑦	⑧

- 1** - Thyristor
- 2** - Essential part number
- 3** - 0 = Converter grade
- 4** - C = Ceramic Puk
- 5** - Voltage code: Code x 100 = V_{RRM} (See Voltage Rating Table)
- 6** - R = Puk Case
- 7** - 0 = Eyelet terminals (Gate and Auxiliary Cathode Unsoldered Leads)
1 = Fast-on terminals (Gate and Auxiliary Cathode Unsoldered Leads)
2 = Eyelet terminals (Gate and Auxiliary Cathode Soldered Leads)
3 = Fast-on terminals (Gate and Auxiliary Cathode Soldered Leads)
- 8** - Critical dv/dt: None = 500V/μsec (Standard selection)
L = 1000V/μsec (Special selection)

Outline Table

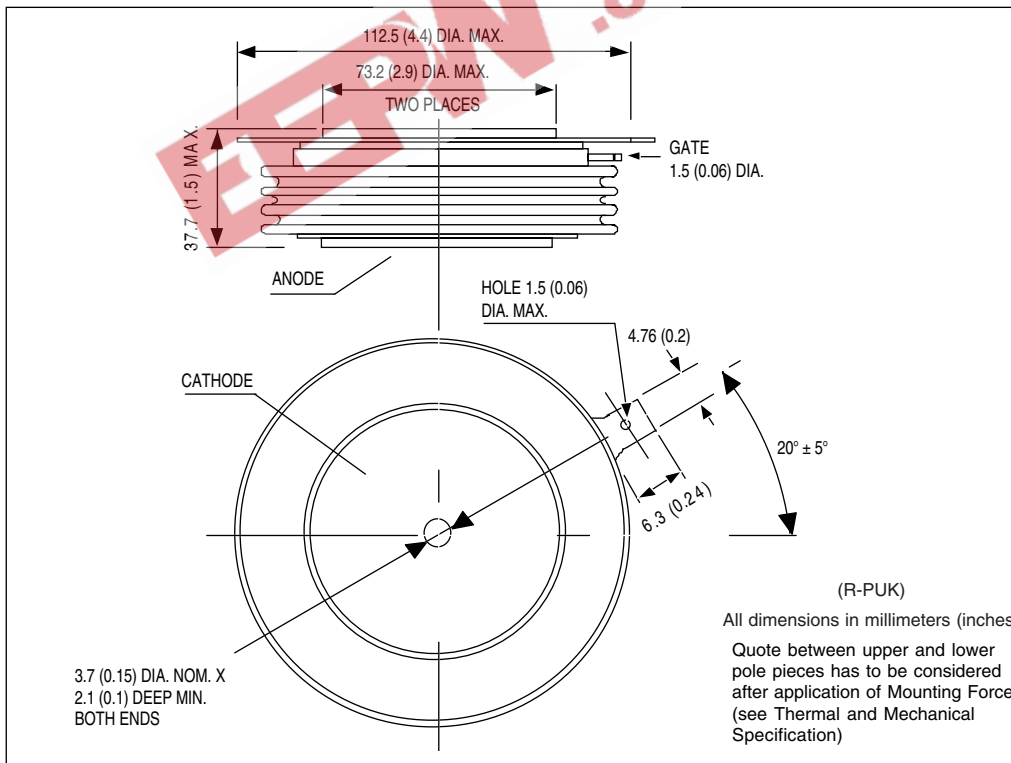

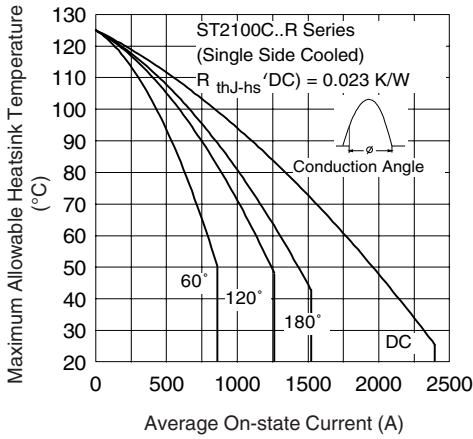

Fig. 1 - Current Ratings Characteristics

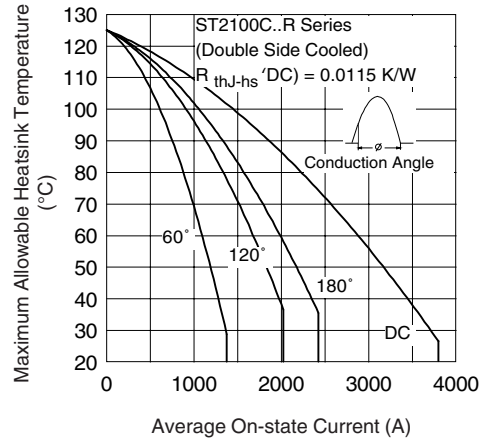

Fig. 2 - Current Ratings Characteristics

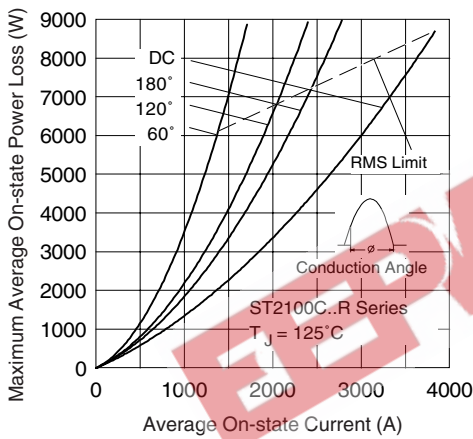

Fig. 3 - On-state Power Loss Characteristics

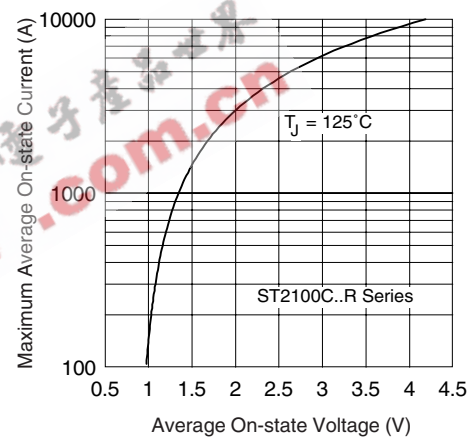

Fig. 4 - On-state Voltage Drop Characteristics

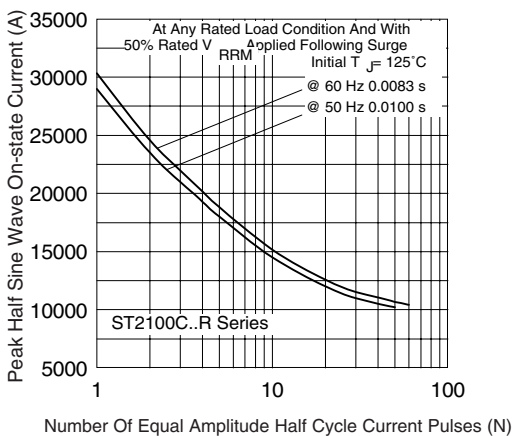

Fig. 5 - Maximum Non-Repetitive Surge Current Single and Double Side Cooled

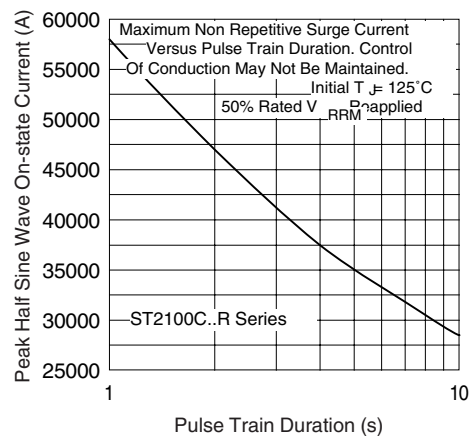

Fig. 6 - Maximum Non-Repetitive Surge Current Single and Double Side Cooled

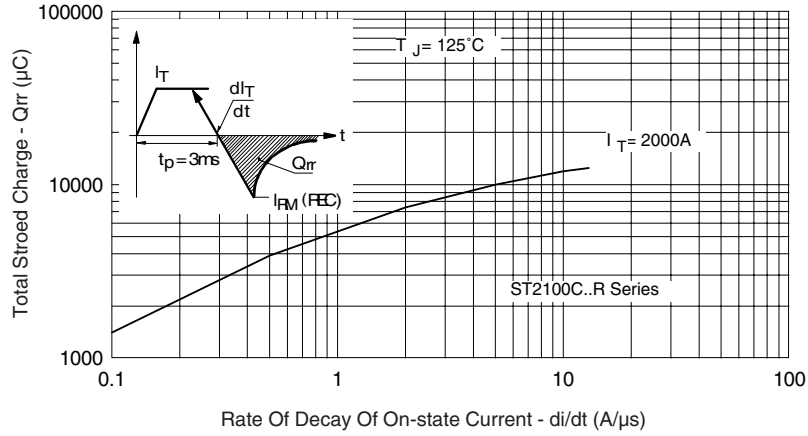

Fig. 7 - Stored Charged

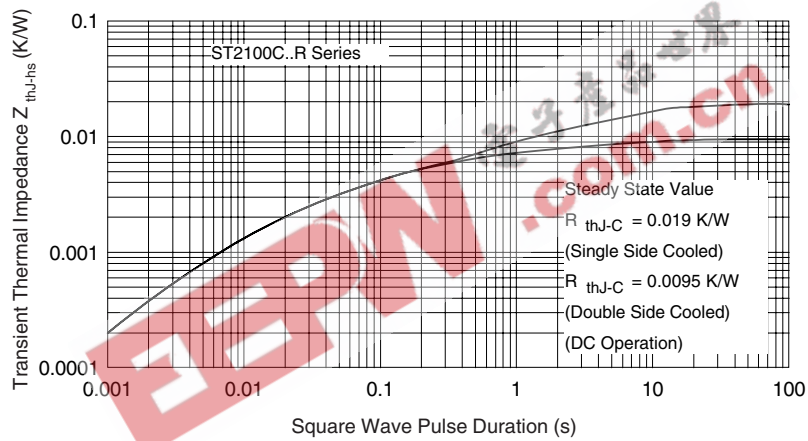

Fig. 10 - Thermal Impedance Z_{thJ-hs} Characteristics

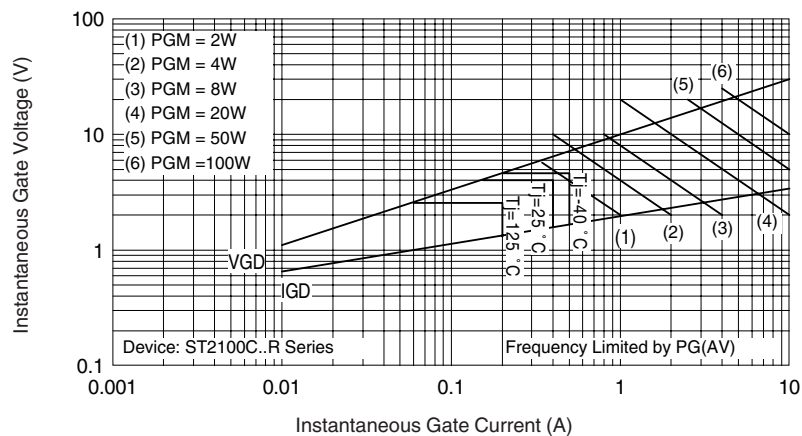

Fig. 11 - Gate Characteristics