

International  
**IR** Rectifier

## ST330C..C SERIES

PHASE CONTROL THYRISTORS

Hockey Puk Version

### Features

- Center amplifying gate
- Metal case with ceramic insulator
- International standard case TO-200AB (E-PUK)

720A

### Typical Applications

- DC motor controls
- Controlled DC power supplies
- AC controllers

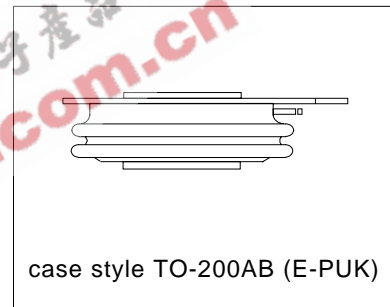

### Major Ratings and Characteristics

Parameters	ST330C..C	Units	
$I_{T(AV)}$	720	A	
@ $T_{hs}$	55	°C	
$I_{T(RMS)}$	1420	A	
@ $T_{hs}$	25	°C	
$I_{TSM}$	@ 50Hz	9000	A
	@ 60Hz	9420	A
$i^2t$	@ 50Hz	405	KA <sup>2</sup> s
	@ 60Hz	370	KA <sup>2</sup> s
$V_{DRM}/V_{RRM}$	400 to 1600	V	
$t_q$	typical	100	μs
$T_J$	- 40 to 125	°C	

## ST330C..C Series

Bulletin I25155 rev. D 04/03

International  
IRF Rectifier

### ELECTRICAL SPECIFICATIONS

#### Voltage Ratings

Type number	Voltage Code	$V_{DRM}/V_{RRM}$ , max. repetitive peak and off-state voltage V	$V_{RSM}$ , maximum non-repetitive peak voltage V	$I_{DRM}/I_{RRM}$ max. @ $T_J = T_J$ max mA
ST330C..C	04	400	500	50
	08	800	900	
	12	1200	1300	
	14	1400	1500	
	16	1600	1700	

#### On-state Conduction

Parameter	ST330C..C	Units	Conditions	
$I_{T(AV)}$ Max. average on-state current @ Heatsink temperature	720 (350)	A	180° conduction, half sine wave double side (single side) cooled	
	55 (75)	°C		
$I_{T(RMS)}$ Max. RMS on-state current	1420	A	DC @ 25°C heatsink temperature double side cooled	
$I_{TSM}$ Max. peak, one-cycle non-repetitive surge current	9000		t = 10ms	No voltage reappplied
	9420		t = 8.3ms	reappplied
	7570		t = 10ms	100% $V_{RRM}$
	7920		t = 8.3ms	reappplied
$I^2t$ Maximum $I^2t$ for fusing	405	KA <sup>2</sup> s	t = 10ms	No voltage reappplied
	370		t = 8.3ms	reappplied
	287		t = 10ms	100% $V_{RRM}$
	262		t = 8.3ms	reappplied
$I^2\sqrt{t}$ Maximum $I^2\sqrt{t}$ for fusing	4050	KA <sup>2</sup> √s	t = 0.1 to 10ms, no voltage reappplied	
$V_{T(TO)1}$ Low level value of threshold voltage	0.91	V	$(16.7\% \times \pi \times I_{T(AV)} < I < \pi \times I_{T(AV)})$ , $T_J = T_J$ max.	
$V_{T(TO)2}$ High level value of threshold voltage	0.92		$(I > \pi \times I_{T(AV)})$ , $T_J = T_J$ max.	
$r_{t1}$ Low level value of on-state slope resistance	0.58	mΩ	$(16.7\% \times \pi \times I_{T(AV)} < I < \pi \times I_{T(AV)})$ , $T_J = T_J$ max.	
$r_{t2}$ High level value of on-state slope resistance	0.57		$(I > \pi \times I_{T(AV)})$ , $T_J = T_J$ max.	
$V_{TM}$ Max. on-state voltage	1.96	V	$I_{pk} = 1810A$ , $T_J = T_J$ max, $t_p = 10ms$ sine pulse	
$I_H$ Maximum holding current	600	mA	$T_J = 25^\circ C$ , anode supply 12V resistive load	
$I_L$ Typical latching current	1000			

#### Switching

Parameter	ST330C..C	Units	Conditions
$di/dt$ Max. non-repetitive rate of rise of turned-on current	1000	A/μs	Gate drive 20V, 20Ω, $t_r \leq 1\mu s$ $T_J = T_J$ max, anode voltage $\leq 80\% V_{DRM}$
$t_d$ Typical delay time	1.0	μs	Gate current 1A, $di_g/dt = 1A/\mu s$ $V_d = 0.67\% V_{DRM}$ , $T_J = 25^\circ C$
$t_q$ Typical turn-off time	100		$I_{TM} = 550A$ , $T_J = T_J$ max, $di/dt = 40A/\mu s$ , $V_R = 50V$ $dv/dt = 20V/\mu s$ , Gate 0V 100Ω, $t_p = 500\mu s$

Blocking

Parameter	ST330C..C	Units	Conditions
dv/dt Maximum critical rate of rise of off-state voltage	500	V/ $\mu$ s	$T_J = T_J$ max. linear to 80% rated $V_{DRM}$
$I_{RRM}$ $I_{DRM}$ Max. peak reverse and off-state leakage current	50	mA	$T_J = T_J$ max, rated $V_{DRM}/V_{RRM}$ applied

Triggering

Parameter	ST330C..C	Units	Conditions
$P_{GM}$ Maximum peak gate power	10.0	W	$T_J = T_J$ max, $t_p \leq 5$ ms
$P_{G(AV)}$ Maximum average gate power	2.0		$T_J = T_J$ max, $f = 50$ Hz, $d\% = 50$
$I_{GM}$ Max. peak positive gate current	3.0	A	$T_J = T_J$ max, $t_p \leq 5$ ms
$+V_{GM}$ Maximum peak positive gate voltage	20	V	$T_J = T_J$ max, $t_p \leq 5$ ms
$-V_{GM}$ Maximum peak negative gate voltage	5.0		
$I_{GT}$ DC gate current required to trigger	TYP.	MAX.	$T_J = -40^\circ\text{C}$ $T_J = 25^\circ\text{C}$ $T_J = 125^\circ\text{C}$ Max. required gate trigger/ current/ voltage are the lowest value which will trigger all units 12V anode-to-cathode applied
	200	-	
	100	200	
$V_{GT}$ DC gate voltage required to trigger	2.5	-	$T_J = -40^\circ\text{C}$
	1.8	3.0	$T_J = 25^\circ\text{C}$
	1.1	-	$T_J = 125^\circ\text{C}$
$I_{GD}$ DC gate current not to trigger	10	mA	$T_J = T_J$ max Max. gate current/voltage not to trigger is the max. value which will not trigger any unit with rated $V_{DRM}$ anode-to-cathode applied
$V_{GD}$ DC gate voltage not to trigger	0.25	V	

Thermal and Mechanical Specification

Parameter	ST330C..C	Units	Conditions
$T_J$ Max. operating temperature range	-40 to 125	$^\circ\text{C}$	
$T_{stg}$ Max. storage temperature range	-40 to 150		
$R_{thJ-hs}$ Max. thermal resistance, junction to heatsink	0.09	K/W	DC operation single side cooled
	0.04		DC operation double side cooled
$R_{thC-hs}$ Max. thermal resistance, case to heatsink	0.02	K/W	DC operation single side cooled
	0.01		DC operation double side cooled
F Mounting force, $\pm 10\%$	9800	N	
	(1000)	(Kg)	
wt Approximate weight	83	g	
Case style	TO-200AB (E-PUK)		See Outline Table

## ST330C..C Series

Bulletin I25155 rev. D 04/03

International  
IRF Rectifier

### $\Delta R_{thJ-hs}$ Conduction

(The following table shows the increment of thermal resistance  $R_{thJ-hs}$  when devices operate at different conduction angles than DC)

Conduction angle	Sinusoidal conduction		Rectangular conduction		Units	Conditions
	Single Side	Double Side	Single Side	Double Side		
180°	0.012	0.011	0.008	0.007	K/W	$T_J = T_{J \text{ max.}}$
120°	0.014	0.012	0.014	0.013		
90°	0.017	0.015	0.019	0.017		
60°	0.025	0.022	0.026	0.023		
30°	0.043	0.036	0.043	0.037		

### Ordering Information Table

Device Code							
ST	33	0	C	16	C	1	
①	②	③	④	⑤	⑥	⑦	⑧
<b>1</b>	- Thyristor	<b>2</b>	- Essential part number	<b>3</b>	- 0 = Converter grade	<b>4</b>	- C = Ceramic Puk
<b>5</b>	- Voltage code: Code x 100 = $V_{RRM}$ (See Voltage Rating Table)	<b>6</b>	- C = Puk Case TO-200AB (E-PUK)	<b>7</b>	- 0 = Eyelet terminals (Gate and Auxiliary Cathode Unsoldered Leads) 1 = Fast-on terminals (Gate and Auxiliary Cathode Unsoldered Leads) 2 = Eyelet terminals (Gate and Auxiliary Cathode Soldered Leads) 3 = Fast-on terminals (Gate and Auxiliary Cathode Soldered Leads)	<b>8</b>	- Critical dv/dt: None = 500V/ $\mu$ sec (Standard selection) L = 1000V/ $\mu$ sec (Special selection)

Outline Table

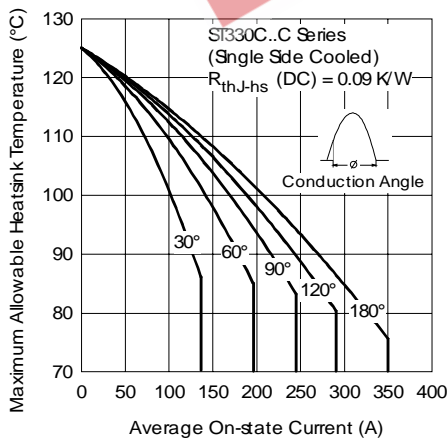
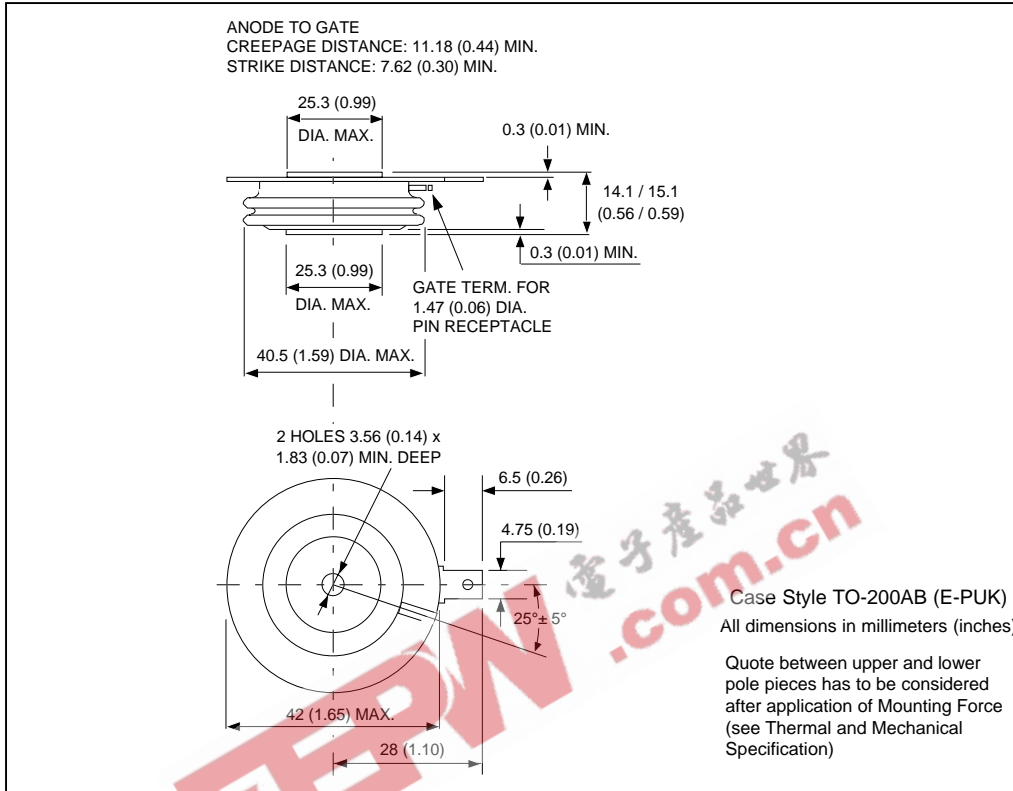

Fig. 1 - Current Ratings Characteristics

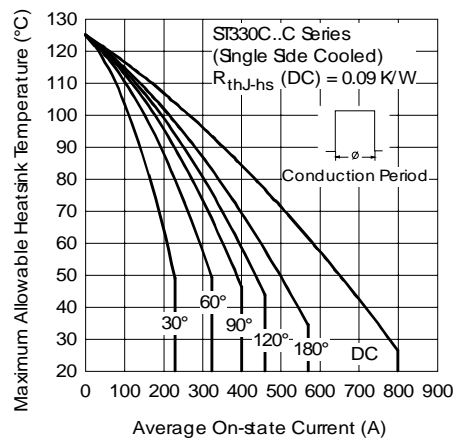

Fig. 2 - Current Ratings Characteristics

# ST330C..C Series

Bulletin I25155 rev. D 04/03

International  
IRF Rectifier

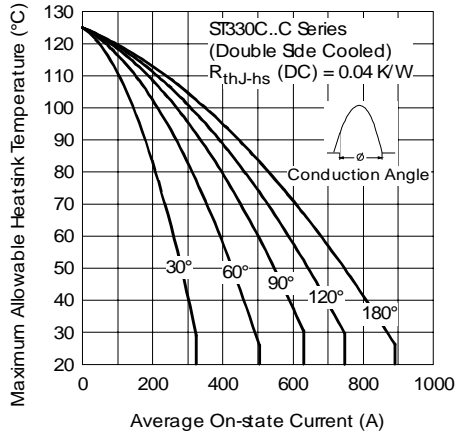

Fig. 3 - Current Ratings Characteristics

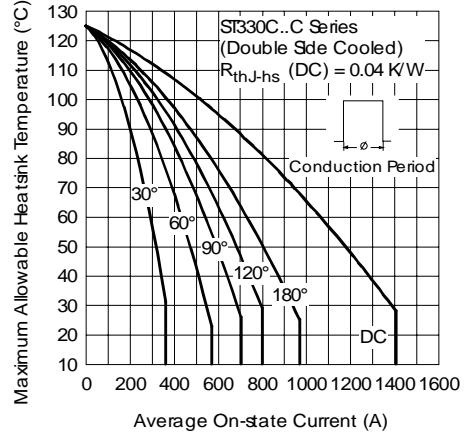

Fig. 4 - Current Ratings Characteristics

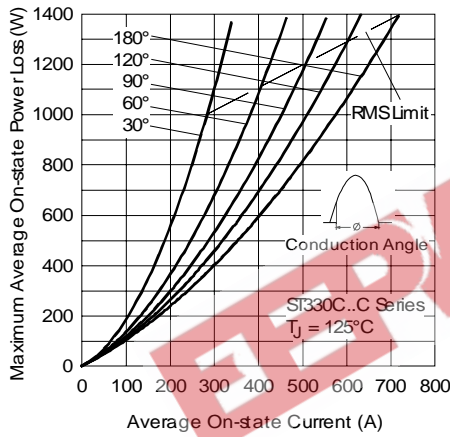

Fig. 5 - On-state Power Loss Characteristics

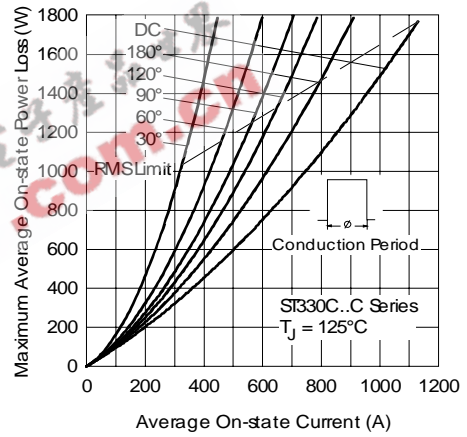

Fig. 6 - On-state Power Loss Characteristics

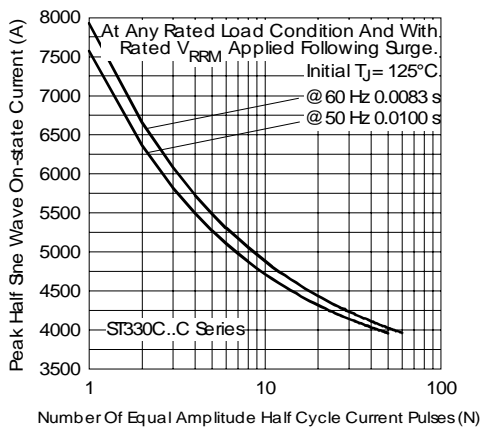

Fig. 7 - Maximum Non-Repetitive Surge Current  
Single and Double Side Cooled

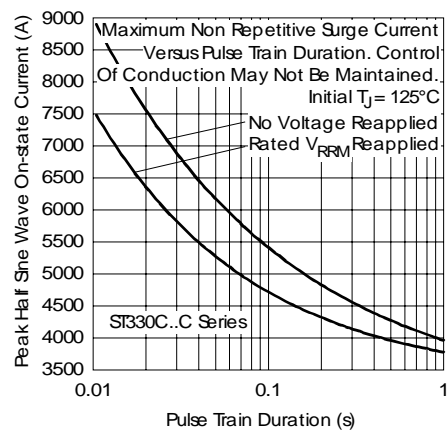

Fig. 8 - Maximum Non-Repetitive Surge Current  
Single and Double Side Cooled

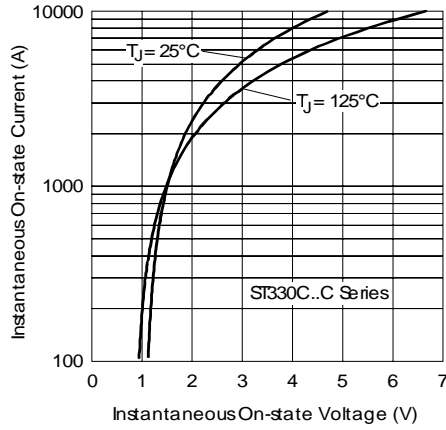

Fig. 9 - On-state Voltage Drop Characteristics

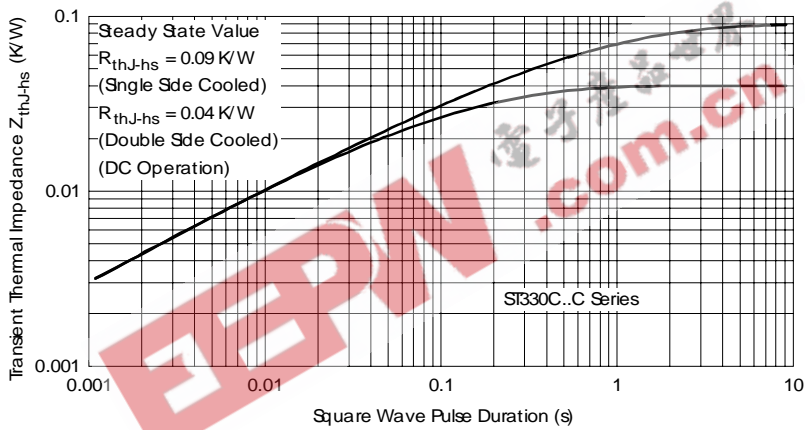

Fig. 10 - Thermal Impedance  $Z_{thj-hs}$  Characteristics

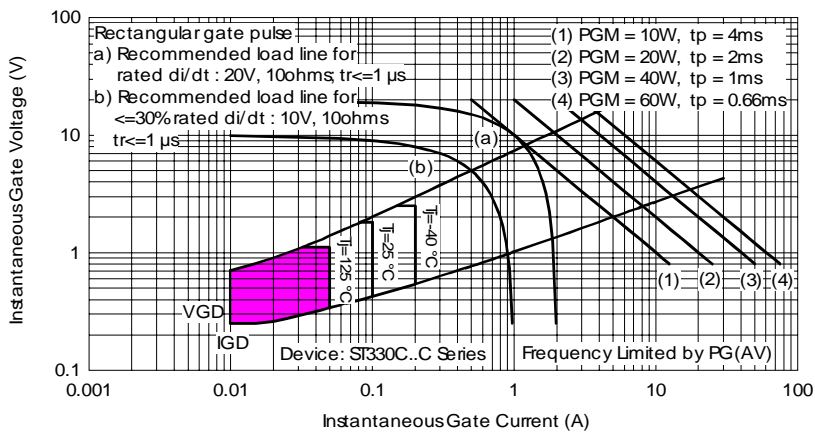

Fig. 11 - Gate Characteristics

**ST330C..C Series**

Bulletin I25155 rev. D 04/03

International  
**IR** Rectifier

EEPW 电子产品世界  
.com.cn

Data and specifications subject to change without notice.  
This product has been designed and qualified for Industrial Level.  
Qualification Standards can be found on IR's Web site.

International  
**IR** Rectifier

**IR WORLD HEADQUARTERS:** 233 Kansas St., El Segundo, California 90245, USA Tel: (310) 252-7105  
TAC Fax: (310) 252-7309  
Visit us at [www.irf.com](http://www.irf.com) for sales contact information. 04 /03